



**REQUEST FOR PROPOSAL  
PHASE XVII (2023)  
(THROUGH OPEN TENDER ENQUIRY)  
FOR SERVICES OF 13,500 OFFSITE ATMs  
UNDER TOTAL OUTSOURCED MODEL (TOM)  
ON PER SUCCESSFUL TRANSACTION BASIS RATE**

**Ref: SBI/AC/2023-24/003 dated: 17/08/2023  
Corrigendum-I Dated 07/09/2023.**

GEM BID NO.: GEM/2023/B/3838738

**State Bank of India  
Anytime Channels,  
Corporate Centre,  
3<sup>rd</sup> Floor,  
World Trade Centre "Arcade",  
Cuffe Parade, Mumbai 400 005**

### Schedule of Events

SI No	Particulars	Remarks
1	Contact details of issuing department (Name, Designation, Mobile No., Email address for sending any kind of correspondence regarding this RFP)	Name: Shri S. Subramanian, DGM (I&R) State Bank of India, Corporate Centre, Anytime Channels Dept, 3 <sup>rd</sup> Floor, World Trade Centre Arcade, Cuffe Parade, Mumbai – 400 005  Email ID: dgmac.ir@sbi.co.in Contact Number: 9619792119
2	Bid Document Availability including changes / amendments, if any to be issued	RFP may be downloaded from Bank's website <a href="https://bank.sbi">https://bank.sbi</a> , GeM Portal <a href="https://gem.gov.in">https://gem.gov.in</a> and <a href="http://www.eprocure.gov.in">www.eprocure.gov.in</a> (CPPP Portal) from 17 August 2023 @ 03:00 PM.  Bidders to note that RFP process shall be done on GeM Portal. Any amendments, modifications, Pre-Bid replies & any communication etc. shall be uploaded on GeM Portal. No individual communication will be sent to the individual bidder.  The Bank reserves the right to Cancel or postpone the tender at any stage without assigning any reason whatsoever.
3	Last date for requesting clarifications (Pre-Bid queries)	Upto 24/08/2023 (date); 03:00 PM (time) All communications regarding points / queries requiring clarifications shall be given in writing or by e-mail. Participating bidders may submit their queries pertaining to the bid as per GeM. a. Subsequent changes / amendments / Corrigendum(a) made by Bank or based on the suggestions and clarifications as per pre-bid meeting shall be deemed to be a part of the RFP

SI No	Particulars	Remarks
		<p>document and shall be uploaded on GeM Portal Only.</p> <p>b. No oral or individual consultation shall be entertained.</p> <p>c. Non reply to any of the queries raised by the vendors shall NOT be considered as acceptance of the query / issue by the Bank.</p> <p>All communications regarding queries requiring clarifications shall be uploaded at GeM Portal or on email as per bank discretion, Bidder shall submit their query strictly in the format enclosed as <b>Appendix-L.</b></p>
4	Pre - bid Meeting at (venue)	<p>State Bank of India, Anytime Channels Dept., 3<sup>rd</sup> Floor, World Trade Centre, "Arcade", Cuff parade, Mumbai – 400 005 or through Online Meeting.</p> <p>On 28/08/2023 @ 11:00 AM</p>
5	Clarifications to queries raised at pre-bid meeting will be provided by the Bank.	On <del>01/09/2023 (date)</del> 07/09/2023
6	Last date and time for Bid submission	Last Date: <del>08/09/2023</del> 21/09/2023 upto 03:00 PM
7	Date and Time of opening of Technical Bids	<p><del>08/09/2023</del> 21/09/2023 @ 3:30 PM</p> <p>Authorized representatives of Bidders may be present online during opening of the Technical Bids. However, Technical Bids would be opened even in the absence of any or all of the Bidder representatives.</p>
8	Address for submission of Bids	Online through GeM Portal and physical documents as per this RFP shall be submitted to following address:

SI No	Particulars	Remarks
		State Bank of India, Corporate Centre, Anytime Channel Department, 3 <sup>rd</sup> Floor, World Trade Centre, "Arcade" Cuffe Parade, Mumbai 400005.
9	Opening of Indicative Price Bids	Indicative Price Bid of technically qualified bidders only will be opened on subsequent date.
10	Reverse Auction	Reverse auction shall be as per GeM guidelines on subsequent date which will be communicated to such Bidders who qualify in the Technical Bid.
11	Tender Fee	<p><b>Rs. 25,000/-</b></p> <p>Amount should be deposited through Demand Draft, favouring State Bank of India payable at Mumbai, against this RFP before submission of bid.</p> <p>Draft Date should not be prior to RFP float date.</p> <p>Tender fee will be non-refundable.</p> <p>Concession as per MSMED Act will be extended to eligible MSE vendors on production of appropriate documents issued by competent Govt. authorities.</p>



SI No	Particulars	Remarks		
12	Earnest Money Deposit	<p>The <b>EMD for an amount of Rs. 2.00 crores</b> in the form of Bank Guarantee (valid for <del>01 Year</del> 180 days). <del>from the date of bid submission date</del> Issuance date of EMD shall be in between the Bid publish date and bid submission date and to be submitted physically to:</p> <p>The Deputy General Manager (Anytime Channel - I&amp;R), State Bank of India, Anytime Channels Dept., 3<sup>rd</sup> Floor, World Trade Centre, "Arcade", Cuffe Parade, Mumbai – 400 005.</p> <p>Subscribed "EMD for RFP No.: <b>SBI/AC/2023-24/003</b> dated: <b>17/08/2023</b> and subsequent amendments thereto.</p> <p>Bank Guarantee [on the lines of <b>EMD Format Appendix-H</b>], issued by Scheduled Commercial Bank in India, other than State Bank of India, drawn in favour of State Bank of India payable at Mumbai. EMD date should not be prior to RFP Float date.</p> <p>Bidder should submit EMD and Tender Fee separately.</p>		
14	Performance Bank Guarantee	<table border="1"> <tr> <td data-bbox="770 1400 1002 1986"> <p><del>08%</del> <b>05%</b> of TCO for the entire period of the contract.</p> </td> <td data-bbox="1002 1400 1372 1986"> <p>Bank Guarantee [on the lines of <b>Appendix-H</b>], issued by Scheduled Commercial Bank in India, other than State Bank of India, drawn in favour of State Bank of India payable at Mumbai. Bank guarantee should be valid for 96 months from the effective date of the Contract. In case Bank extends the contract further PBG may</p> </td> </tr> </table>	<p><del>08%</del> <b>05%</b> of TCO for the entire period of the contract.</p>	<p>Bank Guarantee [on the lines of <b>Appendix-H</b>], issued by Scheduled Commercial Bank in India, other than State Bank of India, drawn in favour of State Bank of India payable at Mumbai. Bank guarantee should be valid for 96 months from the effective date of the Contract. In case Bank extends the contract further PBG may</p>
<p><del>08%</del> <b>05%</b> of TCO for the entire period of the contract.</p>	<p>Bank Guarantee [on the lines of <b>Appendix-H</b>], issued by Scheduled Commercial Bank in India, other than State Bank of India, drawn in favour of State Bank of India payable at Mumbai. Bank guarantee should be valid for 96 months from the effective date of the Contract. In case Bank extends the contract further PBG may</p>			

SI No	Particulars	Remarks	
			be provided as per the percentage specified in original contract.
15	Contact details of agency appointed for conducting Reverse Auction	Please visit <a href="https://gem.gov.in">https://gem.gov.in</a>	
16	Important Instructions	<p>The bid documents and commercial bid shall be submitted online on GeM portal only as per this RFP document and as per the provisions and terms &amp; conditions of GeM portal.</p> <p>Please make sure that all the documents are properly scanned, legible, properly sealed, stamped and signed by authorised signatory.</p> <p>Bank Guarantee towards Earnest Money Deposit, integrity pact and all such Declarations / Forms / Formats / Documents etc. asked in the RFP, which need to be submitted on Stamp Paper shall be submitted both Online (Scanned Copy) on GeM portal and Offline (Physical Copy) in the Tender Box by the bidder before bid submission timeline</p> <p>Physical Copy as mentioned above, at:</p> <p>State Bank of India, Corporate Centre Anytime Channels Department 3<sup>rd</sup> floor World Trade Centre, "Arcade" Cuffe Parade, Mumbai 400005.</p> <p>Offline documents shall reach us within the stipulated timeline. The Envelope</p>	

SI No	Particulars	Remarks
		<p>containing Offline documents as mentioned above shall contain the name and address of the bidder and name of RFP. If the envelope containing such documents is not sealed and marked in the prescribed manner, the Bank will assume no responsibility for the bid's misplacement or premature opening.</p> <p>The information and documents provided by the bidders in response to this RFP shall become the property of the Bank and will not be returned. Only the Bank Guarantee towards Earnest Money Deposit / Bid Security shall be returned in accordance with relevant clause(s) of this RFP.</p>

Note:

- Bids shall be opened as per the process and guidelines of GeM Portal. Bank is not responsible for non-receipt of responses to RFP within the specified date and time due to any reason including holidays or postal delays. Any bid received after the specified date and time of the receipt of bids prescribed as mentioned above, will not be accepted by the Bank. Bids once submitted will be treated as final and no further correspondence will be entertained on this. No bid will be modified after the specified date & time for submission of bids. No bidder shall be allowed to withdraw the bid.
- Bidders will have to upload scanned copies of various documents required for eligibility and all other documents as specified in RFP, techno-commercial bid in cover-I, and price bid in cover-II. It is the bidder's responsibility to ensure submission of all documents at the time of submission of bid online and no request in this regard shall be entertained post completion of bidding timeline.
- The bidder will have to give an undertaking online / offline that if the information / declaration / scanned documents furnished in respect of eligibility criteria are found to be wrong or misleading at any stage, they will be liable to punitive action.
- EMD and tender fee (demand draft/banker's cheque/pay order) shall be submitted in the electronic format online (by scanning) while uploading the bid. This submission shall mean that EMD and tender fee are received electronically.

However, for the purpose of realisation, the bidder shall send the EMD and demand draft/banker's cheque/pay order in original to the designated officer through post or by hand so as to reach by the time of tender opening. In case of exemption of EMD, the scanned copy of the document in support of exemption will have to be uploaded by the bidder during bid submission.

- The terms and conditions written in this RFP document shall supersede any conflicting terms and conditions mentioned in GeM portal. The Bank's interpretations and decisions will be final and binding on the bidders.

## **CONTENTS**

1. INVITATION TO BID:	12
2. DISCLAIMER:	15
3. DEFINITIONS:	16
4. SCOPE OF WORK:	23
5. ELIGIBILITY AND TECHNICAL CRITERIA:	24
6. COST OF BID DOCUMENT:	26
7. CLARIFICATION AND AMENDMENTS ON RFP/PRE-BID MEETING:	26
8. CONTENTS OF BID DOCUMENT:	27
9. EARNEST MONEY DEPOSIT (EMD):	28
10. BID PREPARATION AND SUBMISSION:	29
11. DEADLINE FOR SUBMISSION OF BIDS:	34
12. MODIFICATION AND WITHDRAWAL OF BIDS:	34
13. PERIOD OF BID VALIDITY AND VALIDITY OF PRICE QUOTED IN REVERSE AUCTION RA):	35
14. BID INTEGRITY:	37
15. BIDDING PROCESS / OPENING OF TECHNICAL BIDS:	37
16. TECHNICAL EVALUATION:	38
17. EVALUATION OF INDICATIVE PRICE BIDS AND FINALIZATION:	39
18. CONTACTING THE BANK:	40
19. AWARD CRITERIA AND AWARD OF CONTRACT:	40
20. POWERS TO VARY OR OMIT WORK:	53
21. WAIVER OF RIGHTS:	54
22. CONTRACT AMENDMENT:	55
23. BANK'S RIGHT TO ACCEPT ANY BID AND TO REJECT ANY OR ALL BIDS:	55
24. BANK GUARANTEES:	55
25. SERVICES:	57
26. PENALTIES:	60
27. RIGHT TO VERIFICATION:	61
28. RIGHT TO AUDIT:	61
29. SUBCONTRACTING:	62
30. VALIDITY OF AGREEMENT:	63
31. LIMITATION OF LIABILITY:	63
32. CONFIDENTIALITY:	64
33. DELAY IN SERVICE PROVIDER'S PERFORMANCE:	65
34. SERVICE PROVIDER'S OBLIGATIONS:	65
35. TECHNICAL DOCUMENTATION:	66
36. INTELLECTUAL PROPERTY RIGHTS AND OWNERSHIP:	66
37. LIQUIDATED DAMAGES:	68
38. CONFLICT OF INTEREST:	68
39. CODE OF INTEGRITY AND DEBARMENT / BANNING:	70
40. TERMINATION FOR DEFAULT:	73
41. FORCE MAJEURE:	75
42. TERMINATION FOR INSOLVENCY:	75
43. TERMINATION FOR CONVENIENCE:	76
44. DISPUTES / ARBITRATION (APPLICABLE IN CASE OF SUCCESSFUL BIDDER ONLY):	76
45. GOVERNING LANGUAGE:	77
46. APPLICABLE LAW:	77
47. TAXES AND DUTIES:	77
48. TAX DEDUCTION AT SOURCE:	78
49. TENDER FEE:	78
50. EXEMPTION OF EMD AND TENDER FEE:	79
51. NOTICES:	79
52. ASSIGNMENT:	80
53. INDEMNITY:	81
54. COMPLIANCE WITH IS SECURITY POLICY:	83
55. CONTRADICTION BETWEEN RFP / SLA:	87

56. SYSTEM INTEGRATION TESTING .....	87
57. CHANGE IN ORDERS.....	88
58 COUNTRY OF ORIGIN / ELIGIBILITY OF PRODUCTS & SERVICES.....	88

## **Appendix**

Appendix-A .....	89
BID FORM (TECHNICAL BID) .....	89
Appendix-B .....	94
BIDDER'S ELIGIBILITY CRITERIA.....	94
Appendix-C.....	100
TECHNICAL & FUNCTIONAL SPECIFICATIONS.....	100
C1 ATM HARDWARE SPECIFICATIONS.	
C2 ATM SOFTWARE SPECIFICATIONS.	
C3 ATM SUPPORT SERVICES	
C4 SPECIFICATIONS OF UPS	
Appendix-D .....	154
BIDDER DETAILS .....	154
Appendix-E .....	155
SCOPE OF WORK .....	155
Appendix-F .....	287
INDICATIVE PRICE BID (F1, F2, F3)	
Appendix-G AND G 1.....	290
CERTIFICATE OF LOCAL CONTENT .....	290
CERTIFICATE OF LOCAL CONTENT .....	290
Appendix-H (H1, H2, H3) .....	292
BANK GUARANTEE FORMATS (H1, H2, H3).....	292
Appendix-I .....	300
PENALTIES .....	300
Appendix-J .....	320
DRAFT SERVICE LEVEL AGREEMENT .....	320
Appendix-K .....	366
NON-DISCLOSURE AGREEMENT .....	366
Appendix-L .....	372
PRE-BID QUERY FORMAT .....	372
<i>Appendix M .....</i>	<i>373</i>
<i>FORMAT FOR SUBMISSION OF CLIENT PEFERENCES.....</i>	<i>373</i>
Appendix-N .....	374
PRE-CONTRACT INTEGRITY PACT .....	374
Appendix-O .....	385
MANUFACTURERS' AUTHORIZATION FORM FOR ATMs.....	385

<i>Appendix-P</i> .....	387
<i>Certificate for Tenders for Works under Rule 144 (xi) General Financial Rules (GFRs), 2017</i> .....	387
<i>Appendix-Q</i> .....	388
<i>RAMP SPECIFICATIONS</i> .....	388
<i>Appendix-R</i> .....	396
<i>Declaration of past and present litigation details</i> .....	396
<i>Appendix-S (S1, S2, S3, S4, S5, S5(a) etc</i> .....	397
<i>Client Certificates</i> .....	397
<i>Appendix-T</i> .....	411
<i>Installation Certificate</i> .....	411
<i>Corrigendum</i> .....	412
<i>Reply to pre-Bid Queries</i> .....	451

**The procurement for Services of 13,500 Offsite ATMs in this Request for Proposal (RFP) on Per Successful Transactions Rate Basis under Total Outsourced Model (TOM) with the scope for upto 25 % (+ or -) Buffer Quota machines and will be for the period of 07 (Seven) years from the date of execution of agreement, which can be extended upto 10 years (i.e., upto another three years in one or more tranches after base 7 years period), at the sole discretion of the Bank and such extension (if any required by Bank) shall be binding on selected bidders.**

## **1. INVITATION TO BID:**

**1.1.** State Bank of India (herein after referred to as 'SBI / the Bank'), having its Corporate Centre at Mumbai, various other offices (LHOs / Head Offices / Zonal Offices / Global Link Services, Global IT Centre, foreign offices etc.) of State Bank of India, branches / other offices, Subsidiaries and Joint Ventures available at various locations and managed by the Bank (collectively referred to as State Bank Group or 'SBG' hereinafter). This Request for Proposal (RFP) has been issued by the Bank on behalf of SBG for **Services Of 13,500 Offsite ATMs On Per Successful Transactions Rate Basis**, under Total Outsourced Model (TOM) with the scope for upto 25 % (+ or -) Buffer Quota machines.

**1.2.** Under this TOM procurement of ATM services (at vendor's Cost), Bank is looking for the following:

**1.2.1** Installation of all Brand New 13,500 ATMs as per the Technical and other specifications mentioned in the later part of this RFP (Appendix-C1 to C4) including all Physical and Digital Security Guidelines.

**1.2.2 Site Implementation Services (SIS)** → Site creations / ~~renovation~~ **Refurbishment / renew** (in case of existing sites) as per the Bank's Ambiance Guidelines specified in this RFP (Appendix-E). The SIS will take care of strengthening physical security by concealment of all loose wires, power, network ports, grouting / de-grouting, creation of back rooms etc., placing the machine through a false wall such that only front portion is available and the back portion with concealed wires is in the backroom, improving lighting of the room, providing RAMP facility and any other repair work alongwith statutory and mandatory requirement required at the ATM sites. ~~Providing RAMP facility is mandatory. If RAMP is not feasible at the existing site, the ATM lobby should be shifted to a site with Ramp~~ All ATM sites should be equipped with RAMP facility as per regulatory guidelines.

**1.2.3** Maintenance of ATMs with allied peripherals (like ACs, UPS, Fast charging SMF (Sealed Maintenance Free) / Lithium-ion Batteries with Integrated Power Management Solution, stabilizers, etc.), maintenance of sites,



including AMC (Annual Maintenance Contract) of all components, First Line Maintenance (FLM), Second Line Maintenance (SLM) of the machines, equipment etc.

- 1.2.4 Providing Dual modes of Network Connectivity as per the specifications mentioned in this RFP.
- 1.2.5 Cash Replenishment Services / Cash Evacuation Services with lockable cassette swap method (Mandatory ab-initio) for all machines, usage of OTC (One time Combination) in vault locks of machines ab-initio. Vendors to arrange and maintain (including replacement of faulty ones) for all set(s) of lockable cassettes + reject / retract / counterfeit bins, as and when required, during the entire contract period and extensions thereof.
- 1.2.6 E-surveillance Systems at all sites as per the specifications mentioned in this RFP under e-Surveillance Section.
- 1.2.7 Implementation of External Digital Signage Solution (EDSS) alongwith its maintenance as per Bank's requirements and demand during full contract period (site selection for EDSS shall be as per Bank's discretion and binding to Vendor(s)).
- 1.2.8 Maintenance Services of all sites as per the requirements mentioned in this RFP.
- 1.2.9 Housekeeping Services will be optional services and Bank may take this service as per the requirements mentioned in this RFP. The additional per successful transaction rate will be derived under optional item of price bid. **Bank shall withdraw housekeeping services, if allotted, anytime during contract period and extension thereof by furnishing one month notice to bidder(s).**
- 1.2.10 Caretaker Services at sites wherever required by the Bank, State / District / Local Administration / GoI / IBA / RBI / MHA / NPCI etc.
- 1.2.11 All existing Compliances of Guidelines / Advisory / Orders/ statutory Instructions/ SOP issued by Bank, State / District / Local Administration / GoI / IBA / RBI / MHA / NPCI etc. to be followed and complied by the successful bidders ab-initio and throughout the contract period for each machine / site. Any **new** future guidelines /advisory by any statutory / **regulatory** authority shall be complied **without any cost to the Bank with mutually agreed terms & conditions and within the timeline advised by the authority.**

1.2.12 For all above requirements and all work as described in Scope of Work of this RFP including further corrigendum / addendum, if any, Bank shall be paying on Per Successful Transaction Basis only (unless specifically mentioned and agreed upon in writing by Bank otherwise), as per the discovered rates through this RFP.

1.2.13 Vendor to comply with Bank's IS Policy, as updated from time to time without any additional cost to the Bank.

**1.3.** To meet the commencement of service requirements / engagement, the Bank proposes to invite bids from all eligible vendors to undertake work under this RFP as per details / **Scope of Work** mentioned in **Appendix-E** of this RFP document. The proposed machines and Support Services must integrate with Bank's existing infrastructure seamlessly at vendor's cost.

**1.4.** Bidder shall mean any entity (i.e., juristic person) who meets the eligibility criteria given in **Appendix-B** of this RFP and willing to provide the Services as required in this RFP. The interested Bidders who agree to all the terms and conditions contained in this RFP may submit their Bids with the information desired in this RFP. Consortium bidding is not permitted under this RFP.

**1.5.** Address for submission of Bids, contact details including email address for sending communications are given in Schedule of Events of this RFP.

**1.6.** The purpose of SBI behind this RFP is to seek a detailed technical and commercial proposal for procurement of the Services desired in this RFP.

**1.7.** This RFP document shall not be transferred, reproduced or otherwise used for purpose other than for which it is specifically issued.

**1.8.** Interested Eligible Bidders are advised to go through the entire RFP before submission of Bids to avoid any chance of elimination. The eligible Bidders desirous of taking up the project for providing of proposed Services for SBI are invited to submit their technical and commercial proposal in response to this RFP. The criteria and the actual process of evaluation of the responses to this RFP and subsequent selection of the successful Bidder will be entirely at Bank's discretion. This RFP seeks proposal from Bidders who have the necessary experience, capability & expertise to provide SBI the proposed Services adhering to Bank's requirements outlined in this RFP.

## **2. DISCLAIMER:**

- 2.1.** The information contained in this RFP or information provided subsequently to Bidder(s) whether verbally or in documentary form/email by or on behalf of SBI, is subject to the terms and conditions set out in this RFP.
- 2.2.** This RFP is not an offer by State Bank of India, but an invitation to receive responses from the eligible Bidders.
- 2.3.** The purpose of this RFP is to provide the Bidder(s) with information to assist preparation of their Bid proposals. This RFP does not claim to contain all the information each Bidder may require. Each Bidder should conduct its own investigations and analysis and should check the accuracy, reliability and completeness of the information contained in this RFP and where necessary obtain independent advices /clarifications. Bank may in its absolute discretion, but without being under any obligation to do so, update, amend or supplement the information in this RFP.
- 2.4.** The Bank, its employees and advisors make no representation or warranty and shall have no liability to any person, including any Bidder under any law, statute, rules or regulations or tort, principles of restitution or unjust enrichment or otherwise for any loss, damages, cost or expense which may arise from or be incurred or suffered on account of anything contained in this RFP or otherwise, including the accuracy, adequacy, correctness, completeness or reliability of the RFP and any assessment, assumption, statement or information contained therein or deemed to form or arising in any way for participation in this bidding process.
- 2.5.** The Bank also accepts no liability of any nature whether resulting from negligence or otherwise, howsoever caused arising from reliance of any Bidder upon the statements contained in this RFP.
- 2.6.** The Bidder is expected to examine all instructions, forms, terms and specifications in this RFP. Failure to furnish all information required under this RFP or to submit a Bid not substantially responsive to this RFP in all respect will be at the Bidder's risk and will be considered by the Bank as non-responsive and will be rejected.
- 2.7.** The issue of this RFP does not imply that the Bank is bound to select a Bidder or to award the contract to the Selected Bidder, as the case may be, for the Project and the Bank reserves the right to reject all or any of the Bids or Bidders without assigning any reason whatsoever before issuance of purchase order and / or its acceptance thereof by the successful Bidder as defined in Award Criteria and Award of Contract in this RFP.
- 2.8.** The terms and conditions written in this RFP document shall supersede any conflicting terms and conditions mentioned in GeM portal. The Bank's interpretations and decisions will be final and binding on the bidders.

### 3. DEFINITIONS:

In this connection, the following terms shall be interpreted as indicated below in the RFP:

- 2.1 **“Bank / SBI”** ‘means **State Bank of India**, a Statutory Corporation constituted under the State Bank of India Act, 1955 having its Corporate Centre at SBI Bhawan, Madame Cama Road, Nariman Point, Mumbai 400021 also various other offices (LHOs / Head Offices / Administrative Offices / Regional Business Offices / Global Link Services / Global IT Centre etc.) of State Bank of India, domestic and foreign branches / other offices, other exchange companies available at various locations and managed by the Bank.
- 2.2 **“The Contract”** means the agreement entered into between the Bank and the Successful bidder(s) / Vendor(s), as recorded in the Contract Form signed by the parties, including all attachments and appendices thereto and all documents incorporated by reference therein.
- 2.3 **“RFP” means** the request for proposal (this document) in its entirety, inclusive of any addenda / corrigenda that may be issued by the Bank.
- 2.4 **“Agreement / Service Level Agreement (SLA) means** an agreement is a promise or commitment given by one party to another party. It includes an offer that is made by Bank after reverse auction and accepted by the Vendor(s).
- 2.5 **“The Project”** means takeover, handover and commissioning of Endpoints and making them functional for Services, integration of hardware, software and services with support etc. and other work under the scope of this RFP for the contract period and the extensions thereof.
- 2.6 **“GeM”** GeM is National Public Procurement Portal an end-to-end online Marketplace for Central and State Government Ministries / Departments, Central and State Public Sector Undertakings, Autonomous institutions and Local bodies, for procurement of common use goods and services.
- 2.7 **“TOM”** – Total Outsourced Model i.e. Per Successful Transaction based END to END solutions of the scope of works under this RFP including Installation, testing, commissioning, deployment and maintenance, services of all Machines Hardware’s including all Physical and Digital Security, site identification, site creation / renovation, Site Implementation Services (SIS), as per the Bank’s Ambiance Guidelines, strengthening physical security of all endpoints and their peripherals, concealment of all loose wires, power, network ports, creation of back rooms etc., placing the machine through a false wall such that only front portion is available and the back portion with wires is in backroom, improving and

maintaining sufficient lighting of the ATM room, mandatorily providing RAMP facility, any other repair work required at the ATM sites, Maintenance of machines with allied peripherals (like ACs, UPS, Fast charging SMF / Lithium-ion Batteries, stabilizers etc.), AMC (Annual Maintenance Contract) of all components, First Line Maintenance (FLM), Second Line Maintenance (SLM) of the machines, equipment etc., Providing specified Network Connectivity, Cash Replenishment / evacuation Services through (CRAs / CIT Agencies) with lockable cassette swap method mandatory ab-initio for all machines, usage of OTC (One time Combination) in vault locks of machines ab-initio, e-Surveillance Systems at all sites as per the specifications mentioned in this RFP, Implementation of External Digital Signage Solution at sites (as per Bank's discretion) alongwith its maintenance, Maintenance Services of all sites as per the specifications, Caretaker Services at sites wherever required by the Bank / State / District / Local Administration / Gol / IBA / RBI / MHA / NPCI etc. All existing Compliances of Guidelines / Advisory / Orders/ Instructions / SOP issued by Bank, State / District / Local Administration / Gol / IBA / RBI / MHA / NPCI etc. to be followed by successful bidders ab-initio for each machine / site. Any **new** future guidelines /advisory by any statutory / **regulatory** authority shall be complied **without any cost to the Bank with mutually agreed terms & conditions and within the timeline advised by the authority.**

2.8 **“Vendor(s) / Supplier(s) / Contractor(s) / Service Provider(s) / EndPoint Provider(s)”** is the successful Bidder(s) found eligible as per eligibility criteria set out in this RFP, whose technical Bid has been accepted and who has emerged as one of the Successful Bidder(s) as per the selection criteria set out in this RFP and to whom notification of award has been given by Bank.

2.9 **“Total Project Cost / Total Cost of Ownership: “The Contract Price/ Project Cost”** means the total price (exclusive of all taxes) payable to the Vendor on per successful transaction rate basis for the entire contract period of 7 years as per the calculation method described in the Indicative Commercial Bid Appendix-F for the full and proper performance of its contractual obligations.

2.10 **“Applicant / Bidder / Service Provider / System Integrator”** means an eligible entity / Partnership firm / Company / LLP. submitting a Proposal / the Bid in response to this RFP. The Bidder means an entity capable of providing the sought services under this RFP in TOM and must be an Indian firm / company / organization registered under the Indian Companies Act, 2013/1956.

2.11 **“Proposal / Bid”** means the written reply or submission of response as per requirements mentioned in this RFP.

- 2.12 **“ATM(s) / ATM Machine / Cash Dispenser (CD) / Equipment / Product / Endpoint / Endpoints/ Terminal / Machine”** means – all the hardware, it's all components, peripheral apparatus, associated software/ firmware/ operating software, Software Agent(s). Bank has defined the name of Cash Dispenser (CD) as Automated Teller Machines (ATMs) which has the capability to dispense currency notes after due authentication and support other non-financial transactions (like Balance Enquiry, Mini Statement, PIN change etc.), non-cash financial transactions (like trust donation, college fees payments etc.) of the Bank.
- 2.13 **“Services”** means all hardware and software products, services, scope of work under Appendix-E and deliverables to be provided by a Vendor as described in the RFP and include services ancillary to the development of the solution, such as installation, commissioning, integration with existing systems, provision of technical assistance, training, certifications, auditing and all other obligations of Service Provider covered under this RFP.
- 2.14 **“Endpoint Provider”** means the Vendor who has supplied / is to supply the Endpoints to provide services under this RFP.
- 2.15 **“Solution Provider / MVS Vendor”** means the Vendor Selected by the Bank for implementation of Multi - Vendor Software Solution and Endpoint Protection Solution.
- 2.16 **“VIP Endpoints”** are those endpoints which have been installed at Prime / VIP like Airports, In-touch Branches, E-corners / e-lobby, Railway / Metro Stations, shopping malls, Market Areas, Tech Parks, Important/ main Bank Branches or any other location as identified by the Circles. Bank shall identify specific endpoints not exceeding ~~20%~~ 05% of the endpoints allocated to the respective successful bidder(s) under this RFP as 'VIP Endpoints'. The list of VIP Endpoints can be reviewed by the Bank from time to time.
- 2.17 **“Regular Endpoints”** are all the other endpoints not included in the VIP category.
- 2.18 **“OEM Native Application”** means an application provided by Endpoint Manufacturer to run the Endpoint (ATMs / CDs etc.) (excluding Operating System (OS), Firmware, Middleware, Device drivers, CEN XFS, Terminal Diagnostic Tools/Utilities etc.), following NDC or DDC message emulation protocol.
- 2.19 **“Support Services”** means those services ancillaries to the Endpoint, maintenance, central helpdesk & management centre, its support, troubleshooting and other such obligations.

2.20 **“The Project Site”** means locations where services as desired in this RFP document are to be provided.

2.21 **“ATS”** means Annual Technical Support Services required especially at endpoint level to keep the endpoint up and running smoothly and without interruption.

2.22 **“Annual Maintenance Contract (AMC)”** - It would be the annual cost of maintenance / upkeep / updation of product or specified hardware and software.

2.23 **“Financial Transaction”** means any transaction logged in the switch resulting in cash withdrawal through the endpoint and no reversal generated for such transaction. In future, conversion of Digital Rupee (issued by RBI) into physical currency and its withdrawal will be considered as a Financial Transaction.

2.24 **“Non-Cash Financial Transaction”** means any transaction logged in switch which is a type of transfer transaction and does not involve physical cash withdrawal. Example: Trust Donation, Mobile Top-up, etc. Also, in future, conversion of any account balance amount into Digital Rupee (issued by RBI) and vice-versa, not involving physical cash, will be considered as a “non-cash financial Transaction”.

2.25 **“Non-Financial transaction”** means any transaction logged in the switch which does not result in cash withdrawal through the ATM. Example of non-financial transactions: balance enquiry / mini-statement / PIN-change / and other Value-added services transaction / insufficient funds transaction / wrong pin transaction by the switch and are considered as payable to the Vendor.

2.26 **“Successful Transactions”** means following undernoted transactions which are logged into switch with response code 000 or 001 without any reversals, are only eligible for the **payment of invoices**: -

Financial (@ discovered per successful Financial Transaction rate):

- (i) Cash Withdrawals with no reversal;
- (ii) Cash withdrawals through Conversion of Digital Rupee (issued by RBI) with no reversal.

Non-Financial (@ discovered per non-Financial Transaction rate):

- (i) Balance enquiries;
- (ii) Mini Statements;
- (iii) PIN Changes;
- (iv) Value-added services transactions;

- (v) Non-Cash Financial Transactions like Trust Donation etc.;
- (vi) Insufficient Fund Transactions;
- (vii) Wrong PIN Transactions.

Note: Transactions involving multiple legs shall be considered as one transaction for payment.

All other types of transactions (except under para 3.26.1 and 3.26.2 above) either System generated (like auto reversal postings, Admin transactions, 'Not-on-us' transaction postings to the ATM BGL a/c, profile requests and Money-Drawer messages etc.) or otherwise will not be admissible for the payment of invoices. No payment shall be made for unsuccessful transactions.

- 2.27 **“Unsuccessful Transactions”** means transactions which are not covered in above 3.26 “Successful transactions” above.
- 2.28 **ATM Software** should fully support to resolve any issue / bug related software / hardware / components / services / parameters / configurations / OS / XFS layer / devices / drivers / terminal diagnostic tools / utilities / patches provided by Endpoint provider for smooth running of solutions.
- 2.29 **MVS: Multi-Vendor Software (MVS)** - A standardized secure software solution and platform to run, manage and improve the functionality of the ATM network while providing additional functions like online monitoring of the ATMs.
- 2.30 **“Business Day / working day”** means a day which is not a weekly off including 2<sup>nd</sup> & 4<sup>th</sup> Saturday, Sunday or Public Holiday declared under NI Act.
- 2.31 **“Public Holidays”** shall mean public holidays under NI Act, at the place where the Equipment is located, when banks are closed for business.
- 2.32 **“Occurrence”** means a single event or a series of related event resulting in a loss or losses.
- 2.33 **“Response Time”** means interval between the trigger or alert generated by Bank's ATM Online Monitoring Tool / MVS vendor to the vendor / bidder and latter's arrival time at the respective ATM.
- 2.34 **“Bank Preventable Calls”** means a service call to the vendor / bidder and / or their subcontractors, if any. Bank preventable calls include but are not limited to, calls for FLM to replenish supplies, calls to CRA/CIT Agencies etc.



2.35 “**L1 / L2 / L3 .....so on**” The bidder with the lowest Rate value discovered during the Online Reverse Auction Process is considered as L1; the next bidder with subsequently higher quoted value than L1 will be L2 and so on. All successful bidders shall have to match price of L1.

2.36 “**CRA / CIT Agencies / CIT**” means Cash Replenishment Agencies / Cash-in-Transit Agencies who have been engaged for the cash replenishment in machines & cash evacuation from the machines as specified in the Cash Appendix of this RFP.

2.37 “**Confidential Information**” shall have the meaning set forth in this RFP and / or in SLA.

---

2.38 “**Deficiencies**” shall mean defects arising from non-conformity with the agreed specifications and / or failure or non-conformity in the Scope of the work / Services as mentioned in this RFP.

2.39 “**Documentation**” means documentation that legally binding on all parties to it discharges, varies or supplementals the legal obligations contained in the agreement / SLA/ RFP/letter and will describe in detail and in a completely self-contained manner how the User may access and use the installation of ATMs under Total Outsourced Model \_\_\_\_\_ (name of the Software/ Hardware/ Maintenance Services) <Strike off whichever is inapplicable>, such that any reader of the Documentation can access, use and maintain all of the functionalities of the ..... (Name of Software) ..... (Service), without the need for any further instructions. ‘Documentation’ includes, user manuals, installation manuals, operation manuals, design documents, process documents, technical manuals, functional specification, software requirement specification, on-line tutorials / CBTs, system configuration documents, system / database administrative documents, debugging / diagnostics documents, test procedures, Review Records/ Test Bug Reports/ Root Cause Analysis Report, list of all Product components, list of all dependent/external modules and list of all documents relating to traceability of the Product as and when applicable etc.

2.40 “**Intellectual Property Rights**” shall mean, on a worldwide basis, any and all: (a) rights associated with works of authorship, including copyrights & moral rights; (b) Trade Marks; (c) trade secret rights; (d) patents, designs, algorithms and other industrial property rights; (e) other intellectual and industrial property rights of every kind and nature, however designated, whether arising by operation of law, contract, license or otherwise; and (f) registrations, initial

applications, renewals, extensions, continuations, divisions or reissues thereof now or hereafter in force (including any rights in any of the foregoing).

- 2.41 **“Root Cause Analysis Report”** shall mean a report addressing a problem or non-conformance, in order to get to the ‘root cause’ of the problem, which thereby assists in correcting or eliminating the cause, and prevent the problem from recurring.
- 2.42 **“Commencement of Services”** shall mean the date on which the newly commissioned machine under this RFP is made **“cash-live”** and available for customer cash transactions. **“Cash-live”** means that the cash has been replenished in the machine and ATM performs cash withdrawal transactions successfully.
- 2.43 **“ATM Loss”** means loss of Valuables from a single ATM in respect of which the services are provided. The amount of loss is the face value of the Currency or valuable lost, plus the reasonable cost of reconstructing the negotiable instruments or other items of value (including re-issuance and stop-payment fees), stolen, lost or destroyed as a direct result of the Occurrence. ATM Losses also includes any loss of Valuables occurring outside the immediate physical proximity of the ATM, including but not limited to losses occurring while such Currency notes or Valuables are in transit or are in storage at a vault or similar location.

The amount of an ATM Loss also includes the face value of stolen, lost or destroyed negotiable instruments or other items of value, or any loss of any nature to the extent such loss results from:

- ATM equipment malfunction;
- mistakes in ATM loading, including but not limited to, Currency dispensed due to mis-loaded denominations, mis-configured cassettes, or mis-loaded cassettes etc.;
- discrepancies between network reports and ATM bill counter totals (in the event of such discrepancies, bill counter totals shall be deemed conclusive);
- Bank’s mistakes in verification;
- burglary; or
- damage from breakage;
- Vandalism etc.

**4. SCOPE OF WORK:**

**As given in Appendix–E of this document.**

## 5. ELIGIBILITY AND TECHNICAL CRITERIA:

- 5.1. Bid is open to all Bidders who meet the eligibility and technical criteria as given in **Appendix-B & Appendix-C** of this document, respectively. Bidder can submit only one bid. The Bidder has to submit the documents substantiating the criteria as mentioned in this RFP document.
- 5.2. Bidders to note that: -
- 5.2.1. **Bidders shall source ATM machines, ACs, UPS, Batteries etc. and such other items which are available locally, only from Class -I / Class -II local suppliers. Imported items shall not be supplied for aforesaid items.**
- 5.2.2. ~~The ATM machine of a particular OEM can be supplied by either the OEM themselves OR through their authorized dealers / bidders only. In cases where the manufacturer/ OEM has submitted the bid, the bids of its authorized dealer / bidder will not be considered and EMD will be returned.~~
- 5.2.3. **One bidder can supply ATM machines of one or more OEMs. In this scenario the classification of the bidder as Class I or Class II will be defined based on the local content percentage of the proposed ATM only whichever has the lowest local content percentage.**
- 5.2.4. **The OEM must supply the same model with same specifications to those bidder(s) who propose to supply machine from that OEM.**
- 5.2.5. **The Bidder / Vendor shall not provide / supply / use any imported goods / items / services of the restricted / prohibited goods / items / services by any restricted agency or country, as prohibition / restriction imposed by Gol or / and any Statutory Authority(ies) / Law enforcement agency(ies).**
- 5.2.6. **Bidder / Vendor will follow the guidelines on the Office Memorandum issued by Ministry of Finance on the Insertion of Rule 144 (xi) in the General Financial Rules (GFRs), 2017 dated 23 July 2020 and further amendments & clarifications thereto regarding restrictions on procurement from a bidder of a country which shares a land border with India and on sub-contracting to contractors from such countries.**
- 5.3. The Bidder shall also submit **PRE-CONTRACT INTEGRITY PACT** along with technical Bid as prescribed in **Appendix-N** duly signed by the Bidder on each

page and witnessed by two persons. KYC documents of the Authorized signatories (including witnesses) should be submitted. The **Pre-Contract Integrity Pact** shall be stamped as applicable in the State where it is executed. Bid submitted without Pre-Contract Integrity Pact, as per the format provided in the RFP, shall not be considered.

**5.4.** Bank's MVS, EPS, OMS, other software testing will be a criterion for the successful bidders. The successful bidders must deliver ~~2-ATM~~ machines which are proposed for installation with ~~2~~ UPSs + Fast Charging SMF / Lithium-ion Batteries with atleast 8 hours backup (having Integrated Power Management feature) for testing at the Bank's ATM test Lab located in CBD Belapur, Navi Mumbai ~~within 10 days (calendar days) from the issuance of LOI as per the timeline provided by the Bank.~~ The machines have to be tested successfully for OEM / Native software and Bank's MVS, EPS, OMS platform including completion of EMV L3 certification and other softwares from all the scheme (wherever necessary) within 90 days (calendar days) of delivery of machines. ~~A penalty of Rs 10,000/- per day will be imposed on the bidders if their machines are either undelivered or not tested~~ If any delay (on account of bidder(s)) occurs ~~beyond 15 calendar days either for delivery or successful testing of machines~~ for MVS, EPS, OMS including completion of EMV L3 certification, other software and OEM / Native software within the prescribed timelines, the Bank ~~however has the discretion to review the penalty~~ reserves the right to cancel the allotted quantities and allocate such quantities to other successful bidder(s).

**5.5.** During testing of the supplied machine in the Bank's IT-Lab, if the machine is found to be incompatible with Bank's existing MVS, EPS, OMS, other software, and despite several developments / customizations / modifications by the OEMs, the machine remains incompatible, Bank reserves the right to disqualify that bidder (who supplied that machine) and assign the allocated quota (of this disqualified bidder) to other bidder(s) of this RFP whose machine is tested to be compatible. The timeframe for testing Bank's existing MVS, EPS, other softwares, and several developments / customizations / modifications by the OEMs to make their machines compatible within 90 calendar days from the date of commencement of testing by the Bank. Bank may, at its sole discretion, provide extensions to this timeframe, if deemed necessary. ~~The penalty mentioned in clause 5.4 above shall be applicable.~~ In case, the machines of any successful bidder found incompatible at any stage, Bank at its sole discretion may allocate its respective quotas to other successful bidder(s). Bank, at its discretion, may give the entire procurement to a single vendor whose machine is tested to be compatible, in case a single bidder situation arises.

**5.6.** The bidders must give the declaration signed by their authorized signatory that all the terms and conditions of this RFP and subsequent corrigendum / corrigenda are accepted and bid prepared accordingly.

**6. COST OF BID DOCUMENT:**

The participating Bidders shall bear all the costs associated with or relating to the preparation and submission of their Bids including but not limited to preparation, copying, postage, delivery fees, expenses associated with any demonstration or presentations which may be required by the Bank, or any other costs incurred in connection with or relating to their Bid. The Bank shall not be liable in any manner whatsoever for the same or for any other costs or other expenses incurred by a Bidder regardless of the conduct or outcome of the bidding process.

**7. CLARIFICATIONS AND AMENDMENTS ON RFP / PRE-BID MEETING:**

**7.1.** Bidder requiring any clarification of the bidding document may notify through On-line Portal or any other mode advised by the Bank, strictly as per the format given in **Appendix-L** within the date / time mentioned in the schedule of events.

**7.2.** A pre-Bid meeting will be held on the date and time specified in the Schedule of Events which may be attended by the authorized representatives of the Bidders interested to respond to this RFP.

**7.3.** The queries received (without identifying source of query) and response of the Bank thereof will be posted on GeM Portal and / or on the Bank's website or any other mode conveyed by Bank to the Bidders. That will be final and no further clarifications shall be entertained.

**7.4.** The Bank reserves the right to amend / reissue the RFP, at any time prior to the deadline for submission of Bids. The Bank, for any reason, whether, on its own initiative or in response to a clarification requested by a prospective Bidder, may modify the RFP, by amendment which will be made available to the Bidders by way of corrigendum(a) / addendum(a) on GeM portal and / or on the Bank's website. The interested parties / Bidders are advised to check the same regularly till the date of submission of Bid document specified in the Schedule of Events / email and ensure that clarifications / amendments issued by the Bank, if any, have been taken into consideration before submitting the Bid. Such amendments / clarifications, if any, issued by the Bank will be binding on the participating Bidders. Bank will not take any responsibility for any such omissions by the Bidder. The Bank, at its own discretion, may extend the deadline for submission of Bids in order to allow prospective Bidders a reasonable time to prepare the Bid, for taking the amendment into account or for any other reason(s). Nothing in this RFP or any addenda / corrigenda or clarifications

issued in connection thereto is intended to relieve Bidders from forming their own opinions and conclusions in respect of the matters addresses in this RFP or any addenda / corrigenda or clarifications issued in connection thereto.

**7.5.** No request for change in commercial / legal terms and conditions, other than what has been mentioned in this RFP or any addenda / corrigenda or clarifications issued in connection thereto, will be entertained and queries in this regard, therefore will not be entertained.

**7.6.** Queries received after the scheduled date and time will not be responded / acted upon.

**7.7.** In case of any conflict w.r.t. any clause(s) between the Pre-bid responses released by Bank and this RFP {with its Corrigendum(a)}, the content mentioned in the RFP {with its Corrigendum(a)} shall prevail.

**7.8.** Bank will consolidate all the queries and the replies for the same shall be made available in the Bank's website / GeM Portal or any other Mode deemed fit by the Bank and no individual correspondence shall be made. The clarification of the Bank in response to the queries raised by the Bidders and any clarification / addendum / corrigendum furnished thereof will become part and parcel of the RFP and it will be binding on the Bidders.

## **8. CONTENTS OF BID DOCUMENT:**

**8.1.** The Bidder must thoroughly study / analyse and properly understand the contents of this RFP, its meaning and impact of the information contained therein.

**8.2.** Failure to furnish all information required in this RFP or submission of Bid not responsive to this RFP in any respect will be at the Bidder's risk and responsibility and the same may finally result in rejection of its Bid. The Bank has made considerable effort to ensure that accurate information is contained in this RFP and is supplied solely as guidelines for Bidders.

**8.3.** The Bid prepared by the Bidder, as well as all correspondences and documents relating to the Bid exchanged by the Bidder and the Bank and supporting documents and printed literature shall be submitted in English.

**8.4.** Any information / document (s) provided by the Bidders in response to this RFP will become the property of the Bank and will not be returned. Incomplete information in Bid document may lead to non-consideration of the proposal. If bidders made any concealment or false statement in RFP then their proposal / bid to be cancelled /rejected.

## **9. EARNEST MONEY DEPOSIT (EMD):**

**9.1.** The Bidder shall furnish EMD for the amount and validity period mentioned in **Schedule of Events** of this RFP.

**9.2.** EMD is required to protect the Bank against the risk of Bidder's conduct.

**9.3.** The EMD should be in form of Bank Guarantee (as prescribed in **EMD FORMAT Appendix-H**) issued in favour of State Bank of India by any scheduled commercial bank in India. In case, SBI is the sole banker of the Bidder, a Letter of Comfort from SBI would be acceptable. The scanned copy of original EMD Bank Guarantee should be uploaded on GeM portal along with technical bid. Original EMD Bank Guarantee should be posted /couriered / given in person to the Bank at the address specified in Schedule of Event Sl. No. 1, within the bid submission date and time for the RFP.

**9.4.** Any Bid not accompanied by EMD for the specified amount as mentioned in this RFP will be rejected as non-responsive.

**9.5.** The EMD of the unsuccessful Bidder(s) would be refunded by the Bank within 2 weeks of the Bidder being notified as being unsuccessful.

**9.6.** The EMD of successful Bidder will be discharged upon the Bidder signing the Contract and furnishing the Bank Guarantee for the amount and validity as mentioned in this RFP, which should be strictly on the lines of format placed at **Appendix-H**.

**9.7.** No interest is payable on EMD.

**9.8.** The EMD may be forfeited in following conditions: -

**9.8.1.** if a Bidder withdraws his Bid during the period of Bid validity specified in this RFP; or

**9.8.2.** if a technically qualified Bidder do not participate in the auction by not logging in, in the reverse auction tool; or

**9.8.3.** if a Bidder Conceals / makes any statement or encloses any form which turns out to be false / incorrect at any time prior to signing of Contract; or

**9.8.4.** if the successful Bidder fails to accept Purchase Order and / or sign the contract with the Bank or furnish any bank guarantee(s) mentioned in this RFP, within the specified time period in the RFP or



**9.8.5.** if the Successful bidder fails to provide confirmation on the price quoted during reverse auction.

**9.8.6.** If the machines supplied for services by the successful bidder(s) are incompatible with the Bank's existing MVS, EPS, other software(s), and despite developments / customizations / modifications by the OEMs, machines not become compatible within reasonable time (as deemed fit by bank), the Bank can disqualify the successful bidder(s) as per its sole discretion.

**9.8.7.** If EMD is forfeited for any reasons mentioned above, the concerned Bidder may be debarred from participating in the RFPs floated by the Bank / this department, in future, as per the sole discretion of the Bank.

## **10. BID PREPARATION AND SUBMISSION:**

**10.1 E-Tendering through GeM:** This tender will follow e-Tendering guidelines of GeM portal under which the bidding process shall be conducted by the Bank. Bidder shall necessarily register on GeM portal for participating in the bid. Vendors will have to abide by terms and conditions of GeM portal for participating the bidding process.

10.1.1 This tender will follow Tendering process as under which will be conducted through GeM as under: -

- 10.1.1.1. Vendor Registration.
- 10.1.1.2. Publish of Tender
- 10.1.1.3. Online Pre-Bid Queries Submission by bidders
- 10.1.1.4. Pre-Bid Meeting: / Online
- 10.1.1.5. Online Response of Pre-Bid Queries.
- 10.1.1.6. Corrigendum(a) / Amendment(s) (if required)
- 10.1.1.7. Bid Submission
- 10.1.1.8. Tender Opening
- 10.1.1.9. Pre-Qualification
- 10.1.1.10. Tender Evaluation
- 10.1.1.11. Reverse Auction with Qualified bidders.
- 10.1.1.12. Tender Award.

10.1.2 It is the responsibility of the bidder(s) to get themselves acquainted with the various systems / processes / training etc. for participation, submission of bids, Reverse auction etc. at the GeM portal.

10.1.3 The Vendors are required to have digital certificates well in advance to participate in e-Tendering to be conducted through GeM portal. Vendors will have to abide by e-Business rules framed by the Bank in consultation with GeM portal.

10.1.4 No consideration will be given to e-bids received after the date and time stipulated and no extension of time will normally be permitted for submission of e-Bids. Bank reserves the right to accept in part or in full or extend or reject the entire e-bid and cancel the entire tender without assigning any reason thereof at any stage.

10.1.5 The decision of the bank regarding this tender or tender process shall be final and binding on all the bidders. All disputes or differences in connection with this tender shall be subject to the jurisdiction of the courts at Mumbai or the place of execution of documents.

**10.1.6 Bidders may please note the following: -**

10.1.6.1 The Bid is to be submitted separately for technical and Price on portal of e-Procurement agency and physically to the Bank for procurement for Services of 13,500 Offsite ATMs in this Request for Proposal (RFP) on Per Successful Transactions Rate Basis in response to the **SBI/AC/2023-24/003 dated: 17/08/2023**. The Bidder should quote for the entire package on a single responsibility basis for hardware / software / services, Software Solution / services etc., it proposes to supply.

10.1.6.2 While submitting the Technical Bid, literature on the hardware and its associated operating software, Software Solution/ service etc., should be uploaded.

10.1.6.3 Care should be taken that the Technical Bid shall not contain any price information. Such proposal, if received, will be rejected.

10.1.6.4 The Bid document shall be complete in accordance with various clauses of the RFP document, or any addenda / corrigenda or clarifications issued in connection thereto, duly signed by the authorized representative of the Bidder and stamped with the official stamp of the Bidder. Board resolution authorizing representative to Bid and make commitments on behalf of the Bidder is to be uploaded.

10.1.6.5 Bids are liable to be rejected if only one (i.e., Technical Bid or Indicative Price Bid) is received.

- 10.1.6.6 Prices quoted by the Bidder shall remain fixed for the period during the terms of contracts, shall not be subjected to variation on any account, including exchange rate fluctuations, custom duty etc., however, the Bank will provide CPI(IW) linked increase in per Successful Transaction Rates under Appendix-F as mentioned in this RFP. A Bid submitted with an adjustable price quotation will be treated as non-responsive and will be rejected.
- 10.1.6.7 If deemed necessary, the Bank may seek clarifications on any aspect from the Bidder. However, that would not entitle the Bidder to change or cause any change in the substances of the Bid already submitted or the price quoted.
- 10.1.6.8 The Bidder may also be asked to give presentation for the purpose of clarification of the Bid.
- 10.1.6.9 The Bidder must provide specific and factual replies to the points raised in the RFP.
- 10.1.6.10 The Bid shall be typed or written in indelible ink and shall be digitally signed by the Bidder or a person or persons duly authorized to bind the Bidder to the Contract and to be uploaded in the portal.
- 10.1.6.11 All the enclosures (Bid submission) shall be serially numbered with rubber stamp of the participating Bidder's Company. The person or persons signing the Bids shall initial all pages of the Bids, except for un-amended printed literature and to be uploaded in the portal.
- 10.1.6.12 Any inter-lineation, erasures or overwriting shall be valid only if these are initialled by the person authorized signing the Bids.
- 10.1.6.13 All the envelopes shall be addressed to the Bank and uploaded at the address given as per schedule of events and should have name and address of the Bidder.
- 10.1.6.14 It is mandatory for all the bidders to have class III Digital Signature Certificate (DSC) (in the name of the person who will sign the bid from any of the licensed certifying agency to participate in this RFP. DSC should be in the name of authorized signatory. It should be in Corporate Capacity (that is in Bidder Capacity).
- 10.1.6.15 Bidder(s) should prepare and submit their online Bids well in advance before the prescribed date and time to avoid any delay or problem during

the bid submission process. The Bank shall not be held responsible for any sort of delay, or the difficulties faced by the Bidder(s) during the submission of online Bids.

- 10.1.6.16 All the enclosures (Bid submission) shall be serially numbered, indexed, clearly legible and complete in all respect.
  - 10.1.6.17 Bidder(s) should ensure that the Bid documents submitted should be free from virus and if the documents could not be opened due to virus or otherwise, during Bid opening, the bid is liable to be rejected.
  - 10.1.6.18 The Bank reserves the right to reject Bids not conforming to above and any other bidding process given in this RFP.
- 10.2 Documents to be submitted ONLINE & OFFLINE (Original hard copy to be submitted offline and scanned copy to be uploaded on GeM portal):

**10.2.1** The envelope is to be prominently marked as “**Technical Proposal for SERVICES OF 13,500 ATMs UNDER TOTAL OUTSOURCED MODEL (TOM) ON PER SUCCESSFUL TRANSACTION BASIS – PHASE XVII (Year 2023) in response to the RFP No. SBI/AC/2023-24/003 dated: 17/08/2023.**

This envelope should contain following documents and properly sealed:

- 10.2.1.1 Index of all the documents, letters, bid forms etc. submitted in response to the RFP along with page numbers and properly Flagging of documents with name of document and serial number;
- 10.2.1.2 Bid covering letter / Bid form on the lines of **Appendix-A** on Bidder's letter head;
- 10.2.1.3 Specific response with supporting documents in respect of Eligibility Criteria as mentioned in **Appendix-B** and technical eligibility criteria on the lines of **Appendix-C**;
- 10.2.1.4 If applicable, copy of registration certificate issued by competent authority as mentioned in Eligibility Criteria under **Appendix-B**;
- 10.2.1.5 Bidder's details as per **Appendix-D** on Bidder's letter head;
- 10.2.1.6 Tender Fee Demand Draft;
- 10.2.1.7 Latest and specific Board resolution for Authorized Signatory executing the RFP, SLA and related documents, along with KYC (Aadhar and PAN) of Authorized Signatory. Authority documents of person (s) executing Board Resolution,

- 10.2.1.8 **Appendix-E** (Scope of work), **Appendix-I** (Penalties), **Appendix-J** (SLA), **Appendix-K** (Non-disclosure agreement), **Appendix-M (Client references)**, **Appendix-S and all its sub-parts**, **Appendix-R** (declaration of Past and present litigations);
- 10.2.1.9 Separate sealed Envelope “**Indicative Commercial Bid**” as per format in **Appendix-F (F1, F2, F3)**, duly signed and sealed by the Authorized Signatory;
- 10.2.1.10 Local Content Certificate (**Appendix-G and G-1**);
- 10.2.1.11 EMD Bank Guarantee as per format in **Appendix-H**;
- 10.2.1.12 Pre-Contract Integrity Pact as per format in **Appendix-N**;
- 10.2.1.13 Manufacturer’s Authorization Form (MAF) as per **Appendix-O** for each proposed ATM with the required attachments of Board Resolution / Power of Attorney of authorized signatory;
- 10.2.1.14 A complete write up on security features of each proposed model of ATMs must be provided with the relative technical bid and all technical specifications Brochure;
- 10.2.1.15 Set of Audited Balance sheets and Profit and loss statements including Audit Reports from FY 2019-20 to FY 2021-22 and / or FY 2022-23.
- 10.2.1.16 RFP document alongwith appendixes, duly acknowledged, stamped and signed by authorised signatory on every page;
- 10.2.1.17 Bidders should also submit as part of Technical Bid an overview of Project Management approach and their **Board Approved Business Continuity Plan (BCP)** of the proposed services;
- 10.2.1.18 The proposed networking plan with all technology details;
- 10.2.1.19 The bidders must ensure that all the terms and conditions of this RFP and subsequent corrigendum / corrigenda are acknowledged & accepted and bid prepared and submitted accordingly;
- 10.2.1.20 Any other format / annexure / appendix as desired under the RFP;
- 10.2.1.21 **All Bid documents must duly stamped and signed by authorised signatory as token of acceptance;**
- 10.2.1.22 The Bank reserves the right to reject Bids for not conforming to the terms & conditions of this RFP at any stage(s).

## **11. DEADLINE FOR SUBMISSION OF BIDS:**

- 11.1.** Bids must be submitted online at the GeM portal by the date and time mentioned in the "Schedule of Events". Bidder should submit / upload online documents and also submit offline documents under clause 10 above of this RPF.
- 11.2.** Wherever applicable, the Bidder shall submit the original EMD Bank Guarantee and Pre-Contract Integrity Pact together with their respective enclosures and seal it in an envelope and mark the envelope as "Technical Bid". The said envelope shall clearly bear the name of the project and the name and address of the Bidder. In addition, the last date for bid submission should be indicated on the right-hand corner of the envelope. The original documents should be submitted within the bid submission date and time for the RFP at the address mentioned in Schedule of Events, failing which Bid will be treated as non-responsive.
- 11.3.** In the event of the specified date for submission of Bids being declared a holiday for the Bank, the Bids will be received up to the appointed time on the next working day.
- 11.4.** In case the Bank extends the scheduled date of submission of Bid document, the Bids shall be submitted by the time and date rescheduled. All rights and obligations of the Bank and Bidders will remain the same.
- 11.5.** Any Bid received after the deadline for submission of Bids will not be entertained.

## **12. MODIFICATION AND WITHDRAWAL OF BIDS:**

- 12.1.** The Bidder may modify or withdraw its Bid after the Bid's submission, provided modification, including substitution or withdrawal of the Bids, is received on GeM portal, prior to the deadline prescribed for submission of Bids. In such case, Bidder should submit updated Bids offline also.
- 12.2.** No modification in the Bid shall be allowed, after the deadline for submission of Bids.
- 12.3.** No Bid shall be withdrawn in the interval between the deadline for submission of Bids and the expiration of the period of Bid validity specified in this RFP. Withdrawal of a Bid during this interval may result in the forfeiture of EMD submitted by the Bidder.

### **13. PERIOD OF BID VALIDITY AND VALIDITY OF PRICE QUOTED IN REVERSE AUCTION (RA):**

- 13.1.** Bid alongwith discovered price through reverse auction shall remain valid for duration of 180 days from Bid submission date excluding the actual testing period of the machine(s).
- 13.2.** In exceptional circumstances, the Bank may solicit the Bidders' consent to an extension of the period of validity. The request and the responses thereto shall be made in writing. A Bidder is free to refuse the request. However, in such case, the Bank will not forfeit its EMD. However, any extension of validity of Bids or price will not entitle the Bidder to revise / modify the Bid document.
- 13.3.** Prices payable to the Vendor as stated in the Contract shall be firm and not subject to adjustment during performance of the Contract and extension thereof, irrespective of reasons whatsoever, including exchange rate fluctuations, any upward revision in duties, charges, etc.
- 13.3.1.** However, the Bank will provide an increase in per Successful Transaction Rates under Appendix-F of the RFP. The increase would be indexed to Consumer Price Index (CPI) for Industrial Workers (IW) (All India General Index; Base 2016 = 100). This increase in per successful transaction rate would be approved by the Corporate Centre of the Bank every year with effect from 1<sup>st</sup> May as enumerated in **Clauses 13.3.4 and 13.3.5** below (subject to fulfilment of conditions laid down by Bank) on the Basis of latest available CPI (IW) and advised to all the Circles / selected vendors.
- 13.3.2.** There would be a 2.5% cap on the annual increase in per Successful Transaction Rates. The Increment in payment would be directly correlated to the increase in the Index over 12 months period. For e.g., If the index value on 01<sup>st</sup> May 2023 is 120 which increases to 123 in 01<sup>st</sup> May 2024 thereby representing a 2.5% increase. The per Successful Transaction Rates would increase proportionately. However, if the index value increases beyond 2.5%, the increase in payment would be capped at 2.5%. The maximum Per Successful Financial Transaction Rate for Offsite ATMs permitted during the tenure of contract shall be Rs. 2 less than the prevailing interchange fee. If the difference between the increased price and prevailing Interchange fee is less than Rs. 2, then the per successful transaction rate will freeze (without revision) for the residual period of the contract and extension thereof. It will be revised only when the interchange fee is revised by RBI, subject to increased price shall always remain Rs. 02 less than RBI interchange fee.

**13.3.3.** If there is a decrease in CPI, **the existing rate** (of previous year i.e., prior to 1<sup>st</sup> May of the current year) will apply.

**13.3.4.** The revised rates shall be applicable from 1<sup>st</sup> May subject to the **fulfilment of Rollout Completion Conditions** mentioned below: -

**13.3.4.1.** All allotted base quota of ATMs to the respective successful bidders are **cash live** and available for Customer cash Transactions, **and**

**13.3.4.2.** All SIS (Site implementation services) required for allotted base quota of ATMs to the respective successful bidders are complete, **and**

**13.3.4.3.** All necessary compliances of RBI/IBA/NPCI/GOI/MHA etc. applicable for the base quota, attributable to the bidders, are complied with, **and**

**13.3.4.4.** Bank's MVS, EPS any other software are installed and working on all allotted base quota ATMs to the respective successful bidders.

**13.3.5. Subject to fulfilment of the Rollout Completion Conditions mentioned above (13.3.4.1 to 13.3.4.4):**

**13.3.5.1.** A letter will be issued by the Implementation and rollout department of the Corporate Centre declaring rollout completion, when all the points mentioned above are complied with.

**13.3.5.2.** The first revised rates will be applicable only w.e.f. the upcoming 1<sup>st</sup> May, one year after the Bank declared the **rollout completion date** as above.

For examples:

Complete rollout date	One year from rollout date	Date of 1 <sup>st</sup> CPI rate Applicable
30 Sep 2023	30 Sep 2024	01 May 2025
31 Dec 2023	31 Dec 2024	01 May 2025
31 Mar 2024	31 Mar 2025	01 May 2025
30 Jun 2024	30 Jun 2025	01 May 2026

**13.3.6. Rate revision for Buffer Quota:**

For each installed buffer quota ATM, the prevailing rates for base quota ATM in that current year shall be applicable.



#### **14. BID INTEGRITY:**

Misrepresentation of any fact within the Bid submitted by Bidder, may lead to the cancellation of the bid / contract at the sole discretion of bank, without prejudice to other actions that the Bank may take. All the submissions, including any accompanying documents, will become property of the Bank. The Bidders shall be deemed to license, and grant all rights to the Bank, to reproduce the whole or any portion of their Bid document for the purpose of evaluation and to disclose the contents of submission for regulatory and legal requirements.

#### **15. BIDDING PROCESS / OPENING OF TECHNICAL BIDS:**

- 15.1.** All the technical Bids received up to the specified date and time will be opened for initial evaluation on the date and time mentioned in the Schedule of event. The technical Bids will be opened in the presence of representatives of the Bidders who choose to attend the same on GeM portal. However, Bids may be opened even in the absence of representatives of one or more of the Bidders.
- 15.2.** In the first stage, only technical Bid will be opened and evaluated. Bids of such Bidders satisfying eligibility criteria and agree to comply with all the terms and conditions specified in the RFP, will be evaluated for technical criteria / specifications / eligibility. Only those Bids complied with technical criteria shall become eligible for indicative price Bid opening and further RFP evaluation process.
- 15.3.** The Bank will examine the Bids to determine whether they are complete, required formats have been furnished, the documents have been properly signed, EMD and Tender Fee for the desired amount and validity period is available and the Bids are generally in order. The Bank may, at its discretion waive any minor non-conformity or irregularity in a Bid which does not constitute a material deviation. In case of any ambiguity, Bank may seek clarifications from Bidder subject to no material change / deviation.
- 15.4.** Prior to the detailed evaluation, the Bank will determine the responsiveness of each Bid to the RFP. For purposes of these Clauses, a responsive Bid is one, which conforms to all the terms and conditions of the RFP in toto, without any deviation.
- 15.5.** The Bank's determination of a Bid's responsiveness will be based on the contents of the Bid itself, without recourse to extrinsic evidence.
- 15.6.** After opening of the technical Bids and preliminary evaluation, some or all the Bidders may be asked to make presentations on the Service proposed to be offered by them.

**15.7.** If a Bid is not responsive, it will be rejected by the Bank and will not subsequently be made responsive by the Bidder by correction of the non-conformity.

**16. TECHNICAL EVALUATION:**

- 16.1 Technical evaluation will include technical information submitted as per technical Bid format, demonstration / presentation of proposed product / services, reference calls and site visits, wherever required. The Bidder may highlight the noteworthy / superior features of their product. The Bidder will demonstrate / substantiate all claims made in the technical Bid to the satisfaction of the Bank, the capability of the Equipment, Software and Services to support all the required functionalities at their cost in their lab or those at other organizations where similar product / services is in use.
- 16.2 The Bank reserves the right to evaluate the Bids on technical & functional parameters including visit at factory / workplace and witness demos of the system and verify functionalities, response times, etc.
- 16.3 Bank may evaluate the technical and functional specifications of all the equipment quoted by the Bidder.
- 16.4 During evaluation and comparison of Bids, the Bank may, at its discretion ask the Bidders for clarification on the Bids received. The request for clarification shall be in writing and no change in prices or substance of the Bid shall be sought, offered or permitted. No post Bid clarification at the initiative of the Bidder shall be entertained. However, Bank shall have right to call for any clarifications / any supportive documents from bidders / successful bidders at any stage of RFP.
- 16.5 The evaluation may also consider:
- 16.5.1 The services offered (present or past) by the Bidder to any noticeable bank in India. The Bidder should furnish the details.
  - 16.5.2 Do the proposed services handle the projected volumes and offers a proven solution to meet the requirements?
  - 16.5.3 Are the services offered by the Bidder a complete system or does it have integrations with third party solutions?
  - 16.5.4 Upgrade(s) assurance by the Bidder as per requirements of the Bank for the duration of the project.
  - 16.5.5 Capability of the proposed service to meet future requirements outlined in the RFP.
  - 16.5.6 Support on open platforms and services based on latest technology (both hardware, software, operating software/firmware, database etc.).

16.5.7 Bidder support facilities: Support requirement like online support / email support/ offline support, time period.

16.5.8 Bidder will support the Bank as required in peak days of business (month-end and start of the month) and during switching over process from PR to DR and vice versa.

16.5.9 Bidder should comply with the mandatory requirements as given in appendix-C.

## **17. EVALUATION OF INDICATIVE PRICE BIDS AND FINALIZATION:**

17.1 The envelope containing the indicative Commercial Bids of only those Bidders, who are short-listed after technical evaluation, would be opened.

17.2 All the Bidders who qualify in the evaluation process shall have to participate in the online reverse auction to be conducted by GeM Portal. The business rules, terms and conditions of the reverse auction process are available on the GeM Portal (<https://gem.gov.in>). It is the responsibility of the bidder (s) to get themselves acquainted with the various systems & processes for participation, submission of bids, Reverse auction etc. at the GeM portal.

17.3 Shortlisted Bidders shall be willing to participate in the reverse auction process and must have a valid digital signature certificate. ~~It is responsibility of the Bidder to get self-acquainted with the GeM's System & Process. Such Bidders will be trained by Bank's authorized service provider for this purpose.~~ Bidders shall also be willing to abide by the e-business rules for reverse auction framed by the Bank / ~~Authorized service provider~~ GeM. ~~The details of e-business rules, processes and procedures will be provided to the short-listed Bidders.~~

17.4 Successful Bidders (L1/ L2 /L3..... etc.) will be selected on the basis of per successful transaction rate discovered through the Reverse Auction and the Award Criteria and Award of Contract of this RFP.

17.5 After the Reverse Auction, the Bidder(s) will be required to submit the confirmation of the price quoted (on the lines of Appendix-F {F1, F2, F3}) by bidder in the Reverse Auction within 02 working days of conclusion of the Reverse Auction, failing which Bank may take appropriate action as per its discretion.

17.6 As per the guidelines from the Government of India, Department of Procurement for Industry, and Internal Trade, (DPIIT), the bidders shall source ATM machines, ACs, UPS, Batteries etc. and such other items which are available locally, only

from Class -I / Class -II local suppliers. Imported items shall not be supplied for aforesaid items.

17.7 Errors, if any, in the price breakup format will be rectified as under:

- 17.7.1. If there is a discrepancy between the unit price and total price which is obtained by multiplying the unit price with quantity, the unit price shall prevail and the total price shall be corrected unless it is a lower figure. If the Bidder does not accept the correction of errors, the Bid will be rejected.
- 17.7.2. If there is a discrepancy in the unit price quoted in figures and words, the unit price in figures or in words, as the case may be, which corresponds to the total Bid price for the Bid shall be taken as correct.
- 17.7.3. If the Bidder has not worked out the total Bid price or the total Bid price does not correspond to the unit price quoted either in words or figures, the unit price quoted in words shall be taken as correct.
- 17.7.4. The Bidder should quote for all the items/services desired in this RFP. In case, prices are not quoted by any Bidder for any specific product and / or service, for the purpose of evaluation, the highest of the prices quoted by other Bidders participating in the bidding process will be reckoned as the notional price for that service, for that Bidder. However, if selected, at the time of award of Contract, the lowest of the price(s) quoted by other Bidders (whose Price Bids are also opened) for that service will be reckoned. This shall be binding on all the Bidders. However, the Bank reserves the right to reject all such incomplete Bids.

#### **18. CONTACTING THE BANK:**

- 18.1. No Bidder shall contact the Bank on any matter relating to its Bid, from the time of opening of indicative price Bid to the time, the Contract is awarded.
- 18.2. Any effort by a Bidder to influence the Bank in its decisions on Bid evaluation, Bid comparison or contract award may result in the rejection of the Bid.

#### **19. AWARD CRITERIA AND AWARD OF CONTRACT:**

Guidelines on Public Procurement (Preference to Make in India), Order 2017 (PPP-MII Order and subsequent revisions in 2018~19 with revision dated 16<sup>th</sup> Sep 2020 thereto will be applicable for this RFP and Public Procurement (Preference to Make in India), Order 2017 – Revision vide Order No. P-45021/2/2017-PP (BE-II) dated May 28, 2018 – (Revision order No. P-45021/2/2017-PP (BE-II) dated 16.09.2020) and as per subsequent guidelines issued by Govt of India procurement manual updated up to June 2022 and

clarification office memorandum 04<sup>th</sup> March, 2021 regarding non-local suppliers in respect of imported products and any other time to time Memorandums / Orders / instructions / guidelines issued by Govt of India will be applicable for this RFP and allotment will be done in terms of said Memorandums / Orders / instructions / guidelines accordingly. Bank decision in this regard shall be final and binding to all bidders. As per the guidelines from the Government of India, Department of Procurement for Industry, and Internal Trade, (DPIIT), the bidders shall source ATM machines, ACs, UPS, Batteries etc. and such other items which are available locally, only from Class -I / Class -II local suppliers. Imported items shall not be supplied for aforesaid items.

- 19.1.** Bank intends to allocate procurement of services as per **mentioned** quantities under this RFP among Maximum of Six (06) Successful Bidders (L1 to L6) through GeM Portal. The Bidders will be selected as L1, L2, L3, L4, L5, L6 on the basis of the price discovered in the Reverse Auction, provided L2, L3, L4, L5, L6 matches Reverse Auction price of L1 (i.e., **discovered “A” of the Indicative Commercial Bid**). The allocation of percentage and Number of machines shall be as per following details, **subject to PPP-MII compliance**: -

<b>BIDDER</b>	L1	L2	L3	L4	L5	L6	<b>TOTAL</b>
<b>PERCENTAGE ALLOCATION</b>	25%	23%	21%	19%	6%	6%	<b>100%</b>
<b>NUMBER OF MACHINES ALLOCATION</b>	3,375	3,105	2,835	2,565	810	810	<b>13,500</b>

- 19.1.1.** If only 1 bidder qualifies the technical bid, then Bank reserve the rights to Re-float the RFP OR award the contract to the qualified single bidder as per Bank's sole discretion.
- 19.1.2.** In any scenario mentioned above, if any bidder does not match the discovered reverse auction rate of L1, the Bank may offer the next bidder to match the L1 rate and allocate the quantities among the remaining bidders as per the scenarios mentioned in this RFP.
- 19.1.3.** In case, none of the bidders match the discovered reverse auction rate of L1, the Bank reserves the right to allocate the entire procurement quantity to L1.
- 19.1.4.** In the above cases, the circle-wise allotment for deployment of machines among the successful bidders shall be provided by the Bank after the successful testing of the proposed machines.
- 19.1.5.** Decisions on complaints relating to implementation of the above shall be taken by the competent authority which is empowered to look into

procurement related complaints relating to the procuring entity and it shall be binding on Vendors.

**19.1.6.** The L1 bidder (including other successful bidders matching the L1 price) emerging successful at the end of the Reverse Auction process shall be required to submit their Final price (last bid price) again as per **Appendix-F** within 02 working days. Failure or refusal to offer the services at the price committed through Reverse Auction shall result in forfeit of the EMD with the Bank and / or debar the bidder from participating in future tenders.

**19.1.7. Definitions For the purpose of Public Procurement Preference to Make in India, Order 2017 (PPP-MII Order) and revision thereto:**

**“Local content”** means the amount of value added in India which shall, unless otherwise prescribed by the Nodal Ministry, be the total value of the item procured (excluding net domestic indirect taxes) minus the value of imported content in the item (including all customs duties) as a proportion of the total value, in percent.

**“Class-I local supplier”** means a supplier or service provider whose Goods or services or work offered for procurement meets the minimum local content as prescribed for ‘Class-I local supplier’ hereunder.

**“Class-II local supplier”** means a supplier or service provider whose Goods or services or work offered for procurement meets the minimum local content as prescribed for ‘Class-II local supplier’ hereunder. Class-II local supplier shall not get any purchase preference under this RFP.

**“Non-local supplier”** means a supplier or service provider whose Goods or services or work offered for procurement has ‘local content’ less than that prescribed for ‘Class-II local supplier’ under this RFP.

**Minimum Local content** for the purpose of this RFP, the ‘local content’ requirement to categorize a supplier as ‘Class-I local supplier’ is minimum 50%. For ‘Class-II local supplier’, the ‘local content’ requirement is minimum 20%. If Nodal Ministry/Department has prescribed different percentage of minimum ‘local content’ requirement to categorize a supplier as ‘Class-I local supplier’/ ‘Class-II local supplier’, same shall be applicable.

**“Margin of purchase preference”** means the maximum extent to which the price quoted by a ‘Class-I local supplier’ may be above the L1 for the purpose of purchase preference. The margin of purchase preference shall be 20%.

**19.1.8. Verification of Local content:**

**19.1.8.1.** The 'Class-I local supplier'/ 'Class-II local supplier' at the time of submission of bid shall be required to provide a certificate as per **Appendix-G and G-1** from the statutory auditor or cost auditor of the company (in the case of companies) or from a cost accountant or chartered accountant (in respect of suppliers other than companies) and Company Secretary of the Company giving the percentage of local content requirement for 'Class-I local supplier'/ 'Class-II local supplier' as the case may be, in accordance with Clarification office memorandum 04<sup>th</sup> March, 2021 regarding non-local suppliers in respect of imported products and Guidelines on Public Procurement (Preference to Make in India), Order 2017 (PPP-MII Order and subsequent revisions in 2018~19 with revision dated 16th Sep 2020).

**19.1.8.2.** False declaration (verification of local content) will be in breach of the code of integrity under rule 175 (1) (i) (h) of the General Financial Rules for which a bidder or its successors can be debarred for up to 2 years as per rule 151(iii) of the General Financial Rules along with such other actions as may be permissible under law. Also, Bank may also take suitable action against such false declaration as deemed fit by bank as per its discretion.

**19.1.9.** Purchase Preference applicability in tenders where contract is to be awarded to multiple bidders:

If 'Class I Local suppliers' qualify for award of contract for at least 50% of the tendered quantity in any tender, the contract may be awarded to all the qualified bidders as per award criteria stipulated in the bid documents. However, in case 'Class I Local suppliers' do not qualify for award of contract for at least 50% of the tendered quantity, purchase preference should be given to the 'Class I local supplier' over 'Class II local suppliers' provided that their quoted rate falls within 20% margin of purchase preference of the highest quoted bidder considered for award of contract so as to ensure that the 'Class I Local suppliers' taken in totality are considered for award of contract for at least 50% of the tendered quantity.

All the following scenarios are indicative in nature only for the purpose of compliance of Public procurement (preference to Make in India) order issued by DPIIT dated 16.09.2020 and Manual for Procurement of Goods

.....

(Updated June 2022). ~~and~~ Bank reserves the right to modify the distribution % basing on the emergence of any new scenario **as per Make in India (MII) Guidelines. The Bank will ensure the same** and Bank decision in this regard will be binding to bidders: -

**SCENARIO -I: ONE BIDDER**

When only one technically qualified bidder either Class I Local Supplier or Class II Local Supplier 100% quantity will be allocated as per Bank decision or Bank reserves the right to allocate to single bidder or go for retendering:

BIDDER	L1	TOTAL
<b>PERCENTAGE ALLOCATION</b>	100%	<b>100%</b>

**SCENARIO -II: TWO BIDDERS**

I: When technically qualified two bidders, L-1 and L-2 are Class I Local Supplier:

BIDDER	L1	L2	TOTAL
<b>PERCENTAGE ALLOCATION</b>	60%	40%	<b>100%</b>

II: When technically qualified two bidders, L-1 is Class I Local Supplier and L-2 is Class II Local Supplier:

BIDDER	L1	L2	TOTAL
<b>PERCENTAGE ALLOCATION</b>	60%	40%	<b>100%</b>

III: When technically qualified two bidders, L-1 is Class II Local Supplier and L- 2 is Class I Local Supplier:

BIDDER	L1	L2	TOTAL
<b>PERCENTAGE ALLOCATION</b>	50%	50%	<b>100%</b>



**SCENARIO -III: 03 BIDDERS**

I- When all technically qualified bidders are Class I Local Suppliers, or all are Class II Local Suppliers:

<b>BIDDER</b>	<b>L1</b>	<b>L2</b>	<b>L3</b>	<b>TOTAL</b>
<b>PERCENTAGE ALLOCATION</b>	50%	30%	20%	<b>100%</b>

II-When L1, L2 are Class I Local Suppliers and L3 is Class II Local Supplier:

<b>BIDDER</b>	<b>L1</b>	<b>L2</b>	<b>L3</b>	<b>TOTAL</b>
<b>PERCENTAGE ALLOCATION</b>	50%	30%	20%	<b>100%</b>

III-When L1 is Class I Local Suppliers and L2, L3 are Class II Local Supplier:

<b>BIDDER</b>	<b>L1</b>	<b>L2</b>	<b>L3</b>	<b>TOTAL</b>
<b>PERCENTAGE ALLOCATION</b>	50%	30%	20%	<b>100%</b>

VI-When L1 and L3 are Class I Local Suppliers and L2 is Class II Local Supplier:

<b>BIDDER</b>	<b>L1</b>	<b>L2</b>	<b>L3</b>	<b>TOTAL</b>
<b>PERCENTAGE ALLOCATION</b>	50%	30%	20%	<b>100%</b>

V-When L1 is Class II Local Suppliers and L2 & L3 are Class I Local Supplier:

<b>BIDDER</b>	<b>L1</b>	<b>L2</b>	<b>L3</b>	<b>TOTAL</b>
---------------	-----------	-----------	-----------	--------------

<b>PERCENTAGE ALLOCATION</b>	50%	30%	20%	<b>100%</b>
------------------------------	-----	-----	-----	-------------

**SCENARIO -IV: 04 BIDDERS**

I- When all technically qualified bidders are Class I Local Suppliers or all are Class II Local Suppliers:

<b>BIDDER</b>	L1	L2	L3	L4	<b>TOTAL</b>
<b>PERCENTAGE ALLOCATION</b>	40%	30%	20%	10%	<b>100%</b>

II-When L1, L2, L3 are Class I Local Suppliers and L4 is Class II Local Supplier:

<b>BIDDER</b>	L1	L2	L3	L4	<b>TOTAL</b>
<b>PERCENTAGE ALLOCATION</b>	40%	30%	20%	10%	<b>100%</b>

III-When L1, L2 are Class I Local Suppliers and L3, L4 are Class II Local Supplier:

<b>BIDDER</b>	L1	L2	L3	L4	<b>TOTAL</b>
<b>PERCENTAGE ALLOCATION</b>	40%	30%	20%	10%	<b>100%</b>

VI-When L1 and L3 are Class I Local Suppliers and L2, L4 are Class II Local Supplier:

<b>BIDDER</b>	L1	L2	L3	L4	<b>TOTAL</b>
<b>PERCENTAGE ALLOCATION</b>	40%	30%	20%	10%	<b>100%</b>

V-When L1 and L4 are Class I Local Suppliers and L2, L3 are Class II Local Supplier:

<b>BIDDER</b>	L1	L2	L3	L4	<b>TOTAL</b>
<b>PERCENTAGE ALLOCATION</b>	40%	30%	20%	10%	<b>100%</b>

VI-When L1 Class I Local Suppliers and L2, L3 & L4 are Class II Local Supplier:

<b>BIDDER</b>	L1	L2	L3	L4	<b>TOTAL</b>
<b>PERCENTAGE ALLOCATION</b>	50%	20%	20%	10%	<b>100%</b>

VII-When L1 is Class II Local Suppliers and L2, L3 & L4 are Class I Local Supplier:

<b>BIDDER</b>	L1	L2	L3	L4	<b>TOTAL</b>
<b>PERCENTAGE ALLOCATION</b>	40%	30%	20%	10%	<b>100%</b>

VIII-When L1 and L4 are Class II Local Suppliers and L2, L3 are Class I Local Supplier:

<b>BIDDER</b>	L1	L2	L3	L4	<b>TOTAL</b>
<b>PERCENTAGE ALLOCATION</b>	40%	30%	20%	10%	<b>100%</b>

**SCENARIO -V: 05 BIDDERS**

I- When all technically qualified bidders are Class I Local Suppliers or all are Class II Local Suppliers:

<b>BIDDER</b>	L1	L2	L3	L4	L5	<b>TOTAL</b>
<b>PERCENTAGE ALLOCATION</b>	35%	25%	20%	15%	5%	<b>100%</b>

II-When L1, L2, L3 are Class I Local Suppliers and L4 & L5 are Class II Local Supplier:

<b>BIDDER</b>	L1	L2	L3	L4	L5	<b>TOTAL</b>
---------------	----	----	----	----	----	--------------

<b>PERCENTAGE ALLOCATION</b>	35%	25%	20%	15%	5%	<b>100%</b>
------------------------------	-----	-----	-----	-----	----	-------------

III-When L1, L2 are Class I Local Suppliers and L3, L4 & L 5 are Class II Local Supplier:

<b>BIDDER</b>	L1	L2	L3	L4	L5	<b>TOTAL</b>
<b>PERCENTAGE ALLOCATION</b>	35%	25%	20%	15%	5%	<b>100%</b>

VI-When L1 and L3 are Class I Local Suppliers and L2, L4 & L5 are Class II Local Supplier:

<b>BIDDER</b>	L1	L2	L3	L4	L5	<b>TOTAL</b>
<b>PERCENTAGE ALLOCATION</b>	35%	25%	20%	15%	5%	<b>100%</b>

V-When L1 and L4 are Class I Local Suppliers and L2, L3 & L5 are Class II Local Supplier:

<b>BIDDER</b>	L1	L2	L3	L4	L5	<b>TOTAL</b>
<b>PERCENTAGE ALLOCATION</b>	35%	25%	20%	15%	5%	<b>100%</b>

VI-When L1 & L 5 are Class I Local Suppliers and L2, L3 & L4 are Class II Local Supplier:

<b>BIDDER</b>	L1	L2	L3	L4	L5	<b>TOTAL</b>
<b>PERCENTAGE ALLOCATION</b>	40%	20%	20%	10%	10%	<b>100%</b>

VII-When L1 & L5 are Class II Local Suppliers and L2, L3 & L4 are Class I Local Supplier:

<b>BIDDER</b>	L1	L2	L3	L4	L5	<b>TOTAL</b>
---------------	----	----	----	----	----	--------------

<b>PERCENTAGE ALLOCATION</b>	35%	25%	20%	15%	5%	<b>100%</b>
------------------------------	-----	-----	-----	-----	----	-------------

VIII-When L1 and L4 are Class II Local Suppliers and L2, L3 & L5 are Class I Local Supplier:

<b>BIDDER</b>	L1	L2	L3	L4	L5	<b>TOTAL</b>
<b>PERCENTAGE ALLOCATION</b>	35%	25%	20%	15%	5%	<b>100%</b>

**SCENARIO -VI: 06 BIDDERS**

I- When all technically qualified bidders are Class I Local Suppliers, or all are Class II Local Suppliers:

<b>BIDDER</b>	L1	L2	L3	L4	L5	L6	<b>TOTAL</b>
<b>PERCENTAGE ALLOCATION</b>	25%	23%	21%	19%	6%	6%	<b>100%</b>

II-When L1, L2, L3 are Class I Local Suppliers and L4, L5 & L6 are Class II Local Supplier:

<b>BIDDER</b>	L1	L2	L3	L4	L5	L6	<b>TOTAL</b>
<b>PERCENTAGE ALLOCATION</b>	25%	23%	21%	19%	6%	6%	<b>100%</b>

III-When L1, L2 are Class I Local Suppliers and L3, L4, L5 & L6 are Class II Local Supplier:

<b>BIDDER</b>	L1	L2	L3	L4	L5	L6	<b>TOTAL</b>
<b>PERCENTAGE ALLOCATION</b>	26%	24%	20%	18%	6%	6%	<b>100%</b>

VI-When L1 and L3 are Class I Local Suppliers and L2, L4, L5 & L6 are Class II Local Supplier:

<b>BIDDER</b>	L1	L2	L3	L4	L5	L6	<b>TOTAL</b>
<b>PERCENTAGE ALLOCATION</b>	30%	20%	20%	18%	6%	6%	<b>100%</b>

V-When L1 and L4 are Class I Local Suppliers and L2, L3, L5 & L6 are Class II Local Supplier:

<b>BIDDER</b>	L1	L2	L3	L4	L5	L6	<b>TOTAL</b>
<b>PERCENTAGE ALLOCATION</b>	30%	20%	18%	20%	6%	6%	<b>100%</b>

VI-When L1, L5 & L6 are Class I Local Suppliers and L2, L3 & L4 are Class II Local Supplier:

<b>BIDDER</b>	L1	L2	L3	L4	L5	L6	<b>TOTAL</b>
<b>PERCENTAGE ALLOCATION</b>	30%	20%	20%	10%	10%	10%	<b>100%</b>

VII-When L1, L5 & L6 are Class II Local Suppliers and L2, L3 & L4 are Class I Local Supplier:

<b>BIDDER</b>	L1	L2	L3	L4	L5	L6	<b>TOTAL</b>
<b>PERCENTAGE ALLOCATION</b>	25%	23%	21%	19%	6%	6%	<b>100%</b>

VIII-When L1 and L4 are Class II Local Suppliers and L2, L3, L5 & L6 are Class I Local Supplier:

<b>BIDDER</b>	L1	L2	L3	L4	L5	L6	<b>TOTAL</b>
<b>PERCENTAGE ALLOCATION</b>	25%	23%	21%	19%	6%	6%	<b>100%</b>

Note: Indicative allocation in given scenarios are in percentage however, actual ATM allocation shall be rounded to the nearest whole number. Bank decision in this regard will be binding to bidders: -

**19.1.10. Benefits to Micro and Small Enterprises (MSEs) as per the guidelines of Public Procurement Policy issued by Government of India:** As per the above policy, Bank reserves the rights to procure atleast 25% of the total requirements, from Micro and Small Enterprises (MSEs) provided such MSEs are complying with the eligibility criteria and technical specifications of this RFP, quote their price within the price band of L1+15% and agree to bring down their price to L1 price. {Note: L1 is the least price discovered through the Reverse Auction Process}.  
Bank decision in this regard shall be final and binding to all Bidders.

**19.1.11.** In case,

- I. all bidders are “Class-I local supplier” or
- II. all bidders are “Class-II local suppliers”,

**the allocation shall be done as under:**→ Allocation among the bidders will be done as mentioned in the “**AWARD CRITERIA AND AWARD OF CONTRACT**” clause(s) of this RFP.

**19.1.12.** In case of any dispute / ambiguity / doubt, provisions of public procurement (preference to make in India) order 2017 revision dated 16<sup>th</sup> Sept 2020 and procurement policy updated as on June 2022 and clarification given by DPIIT from time to time, will prevail. Bank decision in this regard shall be final and binding to all Bidders.

**19.1.13. For any scenario after award of contract to successful bidders: -**

**19.1.13.1.** If L1 refuses or non-compliant to any of the terms and conditions of the RFP / SLA at any stage of RFP / in any year of contract period, L2 becomes L1 and L3 becomes L2 and so on.

**19.1.13.2.** If L2 refuse or non-compliant to any of the terms and conditions of the RFP/SLA at any stage of RFP / in any year of contact period, L3 becomes L2 and L4 becomes L3 and so on. ... are awarded the Contract under this RFP.

**19.1.13.3.** If L3 refuse or non-compliant to any of the terms and conditions of the RFP / SLA at any stage of RFP / in any year of contact period, L4 becomes L3

and L5 becomes L4 and so on. ... are awarded the Contract under this RFP.

- 19.1.13.4.** If L4 refuse or non-compliant to any of the terms and conditions of the RFP/SLA at any stage of RFP / in any year of contact period, L5 becomes L4. ... are awarded the Contract under this RFP.
- 19.1.13.5.** If L5 refuse or non-compliant to any of the terms and conditions of the RFP/SLA at any stage of RFP / in any year of contact period, L6 becomes L5. ... are awarded the Contract under this RFP.
- 19.1.13.6.** In the event L2/L3 and so on, are not willing to take or L2/L3 and so on are non-compliant to any of the terms and conditions of the RFP/SLA at any stage of RFP / in any year of contact period, entire procurements may be awarded to declared L1 bidder.
- 19.1.13.7.** In any other scenario(s) after award of contract to successful bidders, any such bidder(s) not willing to take or non-compliant to any of the terms and conditions of the RFP / SLA at any stage of RFP / SLA in any year of contract period, Bank reserve the right to allocate its / their quota(s) to one or among the remaining successful bidders.

**19.2.** Interested Bidders may note following: -

- 19.2.1. Total cost of Services along with cost of all items specified in **Appendix-F** would be the Total Cost of Ownership (TCO) / Total Project Cost **(Excluding Taxes, if any)** based on the discovered per successful transaction rates and the calculation method of TCO as specified in the Appendix-F.,
- 19.2.2. TCO shall be calculated considering 150 (one hundred fifty) Successful Financials Transactions @ discovered rate i.e., "A" as per price bid and 50 (fifty) Non-Financial transactions @ derived rate from "A" as per price bid i.e., "B" at Offsite ATMs.
- 19.2.3. The successful Bidder will have to submit Non-disclosure Agreement as per **Appendix-K**, Performance Bank Guarantee / Bank Guarantee for the amount and validity as desired in this RFP together with acceptance of all terms and conditions of this RFP.
- 19.2.4. Copy of latest and specific Board Resolution and power of attorney (POA wherever applicable) showing that the signatory has been duly authorized



to sign all desired documents under this RFP including the acceptance letter, contract and Non-disclosure Agreement NDA should be submitted with Bid documents.

- 19.2.5. The successful Bidder shall be required to enter into a Contract with the Bank and submit the Bank Guarantee, within 30 days from receipt of formal communication by bank to finally selected bidders or within such extended period as may be decided by the Bank.
- 19.2.6. Till execution of a formal contract, the RFP, along with the Bank's notification of award by way of issuance of LOI / Purchase Order (PO) and Service Provider's acceptance thereof, would be binding contractual obligation between the Bank and the successful Bidder.
- 19.2.7. The Bank reserves the right to ask any document or seek any clarification from bidder at any stage of this RFP, and can also stipulate, at the time of finalization of the Contract, any other document(s) / amendment / addition to be enclosed as a part of the final Contract.
- 19.2.8. Failure of the successful Bidder to comply with the requirements /
- 19.2.9. terms and conditions of this RFP shall constitute sufficient grounds for the annulment of the award and forfeiture of the EMD and/or BG.
- 19.2.10. Upon notification of award to the successful Bidder, the Bank will promptly notify the award of contract to the successful Bidder. The EMD of each unsuccessful Bidder will be discharged and returned.

## **20. POWERS TO VARY OR OMIT WORK:**

- 20.1.** No alterations, amendments, omissions, additions, suspensions or variations of the services (hereinafter referred to as variation) under the contract shall be made by the successful Bidder except as directed in writing by Bank. The Bank shall have full powers, subject to the provision herein after contained, from time to time during the execution of the contract, by notice in writing to instruct the successful Bidder to make any variation without prejudice to the contract. The finally selected Bidder shall carry out such variation and be bound by the same conditions as far as applicable as though the said variations occurred in the contract documents. If any, suggested variations would, in the opinion of the finally selected Bidder, if carried out, prevent him from fulfilling any of his obligations under the contract, he shall notify Bank thereof in writing with reasons for holding such opinion and Bank shall instruct the successful Bidder to make such other modified variation without prejudice to the contract. The finally selected Bidder shall carry out such variation and be bound by the same

conditions as far as applicable as though the said variations occurred in the contract documents. If the Bank confirms its instructions, the successful Bidder's obligations shall be modified to such an extent as may be mutually agreed, if such variation involves extra cost. Any agreed difference in cost occasioned by such variation shall be added to or deducted from the contract price as the case may be.

**20.2.** In any case in which the successful Bidder has received instructions from the Bank as to the requirements for carrying out the altered or additional substituted Services or work which either then or later on, will in the opinion of the finally selected Bidders, involve a claim for additional payments, such additional payments shall be mutually agreed in line with the terms and conditions of the order.

**20.3.** If any change in the services and / or work is likely to result in reduction in cost, the parties shall agree in writing so as to the extent of change in contract price, before the finally selected Bidder(s) proceeds with the change. In all the above cases, in the event of a disagreement as to the reasonableness of the said sum, the decision of the Bank shall prevail.

#### **21. WAIVER OF RIGHTS:**

Each Party agrees that any delay or omission on the part of the other Party to exercise any right, power or remedy under this RFP will not automatically operate as a waiver of such right, power or remedy or any other right, power or remedy and no waiver will be effective unless it is in writing and signed by the waiving Party. Further the waiver or the single or partial exercise of any right, power or remedy by either Party hereunder on one occasion will not be construed as a bar to a waiver of any successive or other right, power or remedy on any other occasion.

## **22. CONTRACT AMENDMENT:**

No variation in or modification of the terms of the Contract shall be made, except by written amendment, signed by the parties.

## **23. BANK'S RIGHT TO ACCEPT ANY BID AND TO REJECT ANY OR ALL BIDS:**

The Bank reserves the right to accept or reject any Bid in part or in full or to cancel the bidding process and reject all Bids at any time prior to contract award as specified in Award Criteria and Award of Contract, without incurring any liability to the affected Bidder or Bidders or any obligation to inform the affected Bidder or Bidders of the grounds for the Bank's action.

## **24. PERFORMANCE BANK GUARANTEE AND BANK GUARANTEE:**

24.1 Performance Bank Guarantee [PBG] shall be of the amount ~~08% (eight%)~~ 05(five)% of the Total Cost of Ownership (TCO) based on the Final reverse auction price (which shall be calculated and advised by the Bank to Selected Bidder(s)) with validity period of 96 months.

24.2 Bank, at its own discretion and option can extend contract period beyond 07 years for further upto 03 years, in one or more tranches. In such condition the existing Performance Bank Guarantee should be extended for the number of extended years + 1 year as advised by the Bank.

24.3 The PBG furnished hereunder should strictly be on the format at Appendix-H and is to be submitted within 30 days of receipt of formal communication by bank to finally selected bidders or within such extended period as may be decided by the Bank.

24.4 For the buffer quota units, additional PBG on same terms and conditions on applicable TCO (for buffer quota) computed for the same calculation method should be submitted by the vendor(s).

24.5 The PBG must be issued by a Scheduled Commercial Bank other than SBI and needs to be submitted within the specified time of receipt of formal communication from the Bank about their Bid finally selected. Purchase Order (PO) will be released only after receipt of the Performance Bank Guarantee. In case, SBI is the sole Banker for the Bidder, a Letter of Comfort from SBI may be accepted.

24.6 The PBG is required to protect the interest of the Bank against delay in supply / installation and / or the risk of non-performance or failure to perform any

obligation(s) under this RFP, either fully or partially, of the successful Bidder in respect of implementation of the project, or performance of the agreement(s) pursuant to this RFP or material or services sold, which may warrant invoking of PBG. In case any act of the supplier results in imposition of Liquidated Damages then also the Bank reserves the right to invoke the PBG.

24.7 The Successful bidder shall submit to the respective Circles / Local Head Office (LHO) a Bank Guarantee for the term of 96 months @ Rs. 50,000/- per endpoint in the specified format for securing the obligations in respect of cash loss in the number of endpoints allotted for cash services in each Circles. For any further addition of endpoints allotted to the Vendor during the currency of the agreement, additional Bank Guarantee on the same terms and conditions for added number of endpoints shall have to be provided by the Vendor to the Circles. Vendor should submit the Bank guarantee to the respective Circles Anytime Channels within 15 days from the issue of PO by Circle. Machines will be made cash live only after the receiving the Bank Guarantee. In case of non-submission of Bank Guarantee within timeline, a penalty of Rs.5,000/- per day per machine will be charged to the vendor from the 16<sup>th</sup> day onwards till the same is submitted. In the event of failure on the part of the vendor to pay for cash losses as per the terms and conditions, the Bank shall be entitled to invoke the guarantee.

24.8 If Service Provider fails to submit Performance Bank Guarantee / Bank Guarantee within the stipulated time schedule as specified in this Agreement , the Bank may without prejudice to its other remedies under the RFP / Agreement, and unless otherwise extension of time is agreed upon without the application of liquidated damages, deduct from the project cost, as liquidated damages a sum equivalent to 0.5% of Total Project Cost allocated to bidder for delay of each week or part thereof maximum up to 5% of Total Project Cost allocated to bidder. Once the maximum deduction is reached, the Bank may consider termination of the Agreement.

24.9 If at any stage, Bank finds that a selected bidder has submitted any kind of false Certifications or Declarations, Bank has the right to reassign the orders to the other selected bidder and the bidder who has given false Certifications or Declarations will be debarred/expelled from executing the orders further and Bank has the right to invoke its Performance Bank Guarantee, as well as initiate any other action as deemed fit by the Bank.

## **25. SERVICES:**

- 25.1 Service Provider should ensure that the quality of methodologies for delivering the services, adhere to quality standards / timelines stipulated thereof.
- 25.2 Service Provider shall provide and implement patches/ upgrades/ updates for products (Software / Firmware/ OS / hardware / software / Operating System / Middleware etc.) as and when released by the Vendor / OEM or as per requirements of the Bank without any additional cost. Service provider should bring to notice of the Bank all releases/ version changes in this regard.
- 25.3 Service Provider shall obtain a written permission from the Bank before applying any of the patches / upgrades / updates. Bidder must support older versions of the hardware / software / Operating System / OS / firmware / Middleware etc. in case the Bank chooses not to upgrade to latest version.
- 25.4 Service Provider shall provide maintenance support for hardware / software / operating system / middleware over the entire period of Contract and extension thereof.
- 25.5 All product updates, upgrades & patches shall be provided by Service Provider free of cost during Contract period and extension thereof.
- 25.6 Service Provider shall support the product or specified hardware / software during the entire period of contract and extension thereof as specified in Scope of work in this RFP.
- 25.7 During the contract period and extension thereof, Service Provider shall maintain the product or specified hardware / software to comply with parameters defined in this RFP. Service Provider shall be responsible for all costs relating to labour, spares, maintenance (preventive and corrective), compliance of security requirements and transport charges from and to the Site (s) in connection with the repair/ replacement of product or specified hardware/software.
- 25.8 During the support period, Service Provider shall ensure that services of professionally qualified personnel are available for providing comprehensive on-site maintenance of the product or specified hardware / software and its components as per the Bank's requirements. Comprehensive maintenance shall include, among other things, day to day maintenance of the product or specified hardware / software a reloading of firmware / software, compliance

to security requirements, etc. when required or in the event of system crash / malfunctioning, arranging and configuring facility as per the requirements of the Bank, fine tuning, system monitoring, log maintenance, etc. Service Provider shall provide services of an expert engineer at SBI GITC, Belapur or at other locations wherever required, whenever it is essential. In case of failure of product or specified hardware / software, Service Provider shall ensure that product or specified hardware / software is made operational to the full satisfaction of the Bank within the given timelines.

25.9 ATS / AMC would be on-site and comprehensive in nature and must have back-to-back support from the OEM. Service Provider shall warrant products against defects arising out of faulty design etc. during the support period.

25.10 In the event of product or specified hardware / software/ operating system break down or failures at any stage, protection available, which would include but not limited to the following, :-

25.10.1. Diagnostics for identification of product or specified hardware/software failures;

25.10.2. Protection of data/ configuration;

25.10.3. Recovery / restart facility;

25.10.4. Backup of product or specified hardware/software / configuration.

25.11 Prompt support shall be made available as desired in this RFP during the support period at the locations as and when required by the Bank.

25.12 Service Provider shall be agreeable for on-call / on-site support during peak weeks (last and first week of each month) and at the time of switching over from PR to DR and vice-versa. No extra charge shall be paid by the Bank for such needs, if any, during the support period.

25.13 Service Provider support staff should be well trained to effectively handle queries raised by the customers / employees of the Bank.

25.14 Updated escalation matrix shall be made available to the Bank once in each quarter and each time the matrix gets changed.

25.15 Preliminary RCA (Root Cause Analysis) of any event to be submitted to the Bank within 24 hours of occurrence of event and thereafter the final RCA to be submitted within a maximum of 72 hours.

- 25.16 All professional services necessary to successfully implement and run the proposed 'product / solution / services' will be part of the RFP / contract. These services include, but are not limited to, Project Management, Training, Deployment methodologies etc.
- 25.17 Service Provider should also submit as part of technical Bid an overview of Project Management approach and their **Board Approved Business Continuity Plan (BCP)** of the proposed services.
- 25.18 Service Provider should ensure that vendor's key personnel with relevant skill sets are available to the Bank or posted at Bank's Offices whenever required by the Bank.
- 25.19 Service Provider should ensure that the quality of methodologies for delivering the products and services, adhere to quality standards / timelines stipulated therefor.
- 25.20 Service Provider shall be willing to transfer skills to relevant personnel from the Bank, by means of training and documentation.
- 25.21 Bidder shall provide legally valid firmware / software solution / operating system. The detailed information on license count and type of license should also be provided to the Bank.
- 25.22 ~~The ownership of the software / firmware / operating system license and the hardware shall be that of the Bank from the date of delivery of the same to the Bank. In other words, wherever the ownership of the licenses/hardware is indicated, the name "State Bank of India" must appear to indicate that the Bank is the perpetual owner of the hardware/operating software /firmware / operating system, etc. associated with the hardware. Evidence in this regard must be submitted before the payment is released. License certificate to be provided by Vendor.~~
- 25.23 The Bidder shall keep the Bank explicitly informed the end of support dates on related products / hardware / firmware / Software and should ensure support during contract period.

**26. PENALTIES:**

As mentioned in **Appendix-I** of this RFP.



## **27. RIGHT TO VERIFICATION:**

The Bank reserves the right to verify any or all of the statements made by the Bidder in the Bid document and to inspect the Bidder's facility, if necessary, to establish to its satisfaction about the Bidder's capacity/capabilities to perform the job.

## **28. RIGHT TO AUDIT:**

- 28.1. The Selected Bidder (Service Provider) shall be subject to annual audit by internal / external Auditors appointed by the Bank / inspecting official from the Reserve Bank of India or any regulatory authority, covering the risk parameters finalized by the Bank / such auditors in the areas of products (IT hardware / Software) and services etc. provided to the Bank and Service Provider is required to submit such certification by such Auditors to the Bank. Service Provider and or his / their outsourced agents / sub – contractors (if allowed by the Bank) shall facilitate the same. The Bank can make its expert assessment on the efficiency and effectiveness of the security, control, risk management, governance system and process created by Service Provider. Service Provider shall, whenever required by the Auditors, furnish all relevant information, records /data to them. All costs for such audit shall be borne by the Bank. Except for the audit done by Reserve Bank of India or any statutory / regulatory authority, the Bank shall provide reasonable notice of not less than One day to Service Provider before such audit and same shall be conducted during normal business hours. Bank also reserves the right for conducting surprise audit. Bidder / vendor shall have obligation to comply with all the recommendations / close all the vulnerabilities reported in the various security review, IS Audit, UAT etc conducted by the Bank, regulators, Bank appointed third party at various stages during the contact period without any additional cost the Bank.”
- 28.2. Where any deficiency has been observed during audit of Service Provider on the risk parameters finalized by the Bank or in the certification submitted by the Auditors, Service Provider shall correct / resolve the same at the earliest and shall provide all necessary documents related to resolution thereof and the auditor shall further certify in respect of resolution of the deficiencies. The resolution provided by Service Provider shall require to be certified by the Auditors covering the respective risk parameters against which such deficiencies have been observed.
- 28.3. Service Provider further agrees that whenever required by the Bank, it will furnish all relevant information, records / data to such auditors and / or inspecting officials of the Bank / Reserve Bank of India and / or any regulatory authority(ies). The Bank reserves the right to call for and / or retain any relevant information / audit reports on financial and security review with their findings undertaken by Service Provider. However, Service Provider shall not be obligated to provide records / data not related to Services under the Agreement (e.g., internal cost breakup etc.).

## **29. SUB-CONTRACTING:**

- 29.1. As per scope of the RFP, sub-contracting of total scope of work is restricted. However, If the Bidder wishes to sub-contract any part of scope of work, it will have to obtain specific written permission from the Bank before subcontracting any work to subcontractors. Bank at its own discretion may permit, deny and review the same. The Bank may at any time during the contract may cancel the permission given for the subcontracting vendor.
- 29.2. In case subcontracting is permitted by the Bank, the Successful bidder will be responsible for all the sub-contracted services provided to the Bank regardless of which entity is conducting the operations. The Successful bidder is also responsible for ensuring that the sub-contractor complies with all Govt / security / statutory / Bank / RBI / MHA guidelines / local administration / Labour Laws etc., requirements of this RFP / SLA of Bank with the Successful Bidder. The Bank can obtain independent audit report for the same. Bidder shall provide subcontracting details along with the copy of the executed Service Level Agreement (SLA) immediately (at least 15 days before commencement of that subcontracting service) to the Bank and if require, Bank may evaluate the same.
- 29.3. Vendor will follow the guidelines on the Office Memorandum issued by Ministry of Finance on the Insertion of Rule 144 (xi) in the General Financial Rules (GFRs), 2017 dated 23 July 2020 and further amendments & clarifications thereto regarding restrictions on procurement from a bidder of a country which shares a land border with India and on sub-contracting to contractors from such countries.
- 29.4. In case of Sub-Contracting (if allowed by the Bank), the Service Provider shall provide the complete details of services sub-contracted by it including the details of sub-contractor(s) and /or its agent along with copy of agreement (SLA) with such sub-contractor to the Bank as and when requested.
- 29.5. In case of any requirement, Bank or its officials shall have right to directly contact / follow-up / instruct to sub-contractor of the Vendor, and such sub-contractor(s) shall respond to bank and follow Bank's such instructions and shall take action accordingly. Vendor shall take care of such clause in subsequent agreement with Sub-contractor(s), if any and shall instruct the same to its sub-contractor(s).

### 30. VALIDITY OF AGREEMENT:

- 30.1. The Agreement / SLA will be valid for the period of Seven (7) years which can be extended upto 10 years (i.e., upto another three years in one or more tranches after base 7 years period), solely at the discretion of the Bank. The Bank reserves the right to terminate the Agreement as per the terms of RFP / SLA.
- 30.2. ~~The Machine Site, for all practical purposes, belongs to the Bank.~~ Service Provider will, ~~therefore~~, not transfer / sell / surrender / vacate the Site or / and enter into any contract / order / agreement with any other Bank / entity for the Site without Bank's permission. The Bank will also have the first right of refusal for the Site on termination / expiry of SLA.

### 31. LIMITATION OF LIABILITY:

- 31.1. The maximum aggregate liability of Service Provider, subject to clause 31.3, in respect of any claims, losses, costs or damages arising out of or in connection with this RFP / Agreement shall not exceed the total Project Cost.
- 31.2. Under no circumstances shall either Party be liable for any indirect, consequential or incidental losses, damages or claims including loss of profit, loss of business or revenue. Service Provider will be liable for any losses incurred by the Bank which are attributable to Service Provider.
- 31.3. The limitations set forth herein shall not apply with respect to:
- 31.3.1. claims that are the subject of indemnification pursuant to infringement of third-party Intellectual Property Right;
  - 31.3.2. damage(s) occasioned by the Gross Negligence or Wilful Misconduct of Service Provider,
  - 31.3.3. damage(s) occasioned by Service Provider for breach of Confidentiality Obligations,
  - 31.3.4. Regulatory or statutory fines / penalty imposed by a Government or Regulatory agency(ies) for non-compliance of statutory or regulatory guidelines applicable to the Bank due to inaction on the part of vendor, provided such guidelines were brought to the notice of service provider. The regulatory and statutory Penalty / fines will be recovered from the vendor for the reasons attributable to the vendor under the services provided by the vendor to the Bank under the project.

For the purpose of clause 31.3.2 "**Gross Negligence**" means any act or omission of act or failure to act by a party which was in reckless disregard of or gross

indifference to the obligation of the party under this Agreement and which causes injury, damage to life, personal safety, real property, harmful consequences to the other party, which such party knew, or would have known if it was acting as a reasonable person, would result from such act or failure to act for which such Party is legally liable. Notwithstanding the forgoing, Gross Negligence shall not include any action taken in good faith.

**“Wilful Misconduct” means** any act or failure to act with an intentional disregard of any provision of this Agreement, which a party knew or should have known if it was acting as a reasonable person, which would result in injury, damage to life, personal safety, real property, harmful consequences to the other party, but shall not include any error of judgment or mistake made in good faith.

### **32. CONFIDENTIALITY:**

32.1 Confidentiality obligation shall be as per Non-disclosure agreement placed as Appendix-K and / or SLA to this RFP.

32.2 Bidder acknowledges and agrees that all tangible and intangible information obtained, developed or disclosed including all documents, contract, purchase order to be issued, data papers and statements and trade secret of the Bank relating to its business practices and their competitive position in the market place provided to the selected Bidder by the Bank in connection with the performance of obligations of Bidder under the purchase order to be issued, in part or complete shall be considered to be confidential and proprietary information (“Confidential Information”) and shall not be disclosed to any third party/published without the written approval of the Bank.

32.3 The Confidential Information will be safeguarded, and Bidder will take all the necessary action to protect it against misuse, loss, destruction, alterations, or deletions thereof. In the event of a breach or threatened breach by Bidder of this section, monetary damages may not be an adequate remedy; therefore, Bank shall be entitled to injunctive relief to restrain Bidder from any such breach, threatened or actual.

32.4 Any document, other than the Contract itself, shall remain the property of the Bank and shall be returned (in all copies) to the Bank on completion of the Vendor’s performance under the Contract, if so, required by the Bank.

32.5 Bidder acknowledges and agrees for data and application privacy and confidentiality during contract period as per Bank norms.

### **33. DELAY IN SERVICE PROVIDER'S PERFORMANCE:**

- 33.1. Services shall be made by Service Provider within the timelines prescribed in this RFP / SLA.
- 33.2. If at any time during performance of the Contract, Service Provider should encounter conditions impeding timely delivery and performance of Services, Service Provider shall promptly notify the Bank in writing of the fact of the delay, its likely duration and cause(s). As soon as practicable after receipt of Service Provider's notice, the Bank shall evaluate the situation and may, at its discretion, extend Service Providers' time for performance, in which case, the extension shall be ratified by the parties by amendment of the Contract.
- 33.3. Any delay in performing the obligation/ defect in performance by Service Provider may result in imposition of penalty, liquidated damages, invocation of PBG / Bank Guarantee and / or termination of Contract (as laid down elsewhere in this RFP document).

### **34. SERVICE PROVIDER'S OBLIGATIONS:**

- 34.1. Service Provider is responsible for and obliged to conduct all contracted activities in accordance with the Contract using state-of-the-art methods and economic principles and exercising all means available to achieve the performance specified in the Contract.
- 34.2. The vendor will be responsible for arranging and procuring all relevant permissions / Road Permits etc. for transportation of the equipment to the location where installation is to be done. The Bank would only provide necessary Purchase Orders / letters for the sites where installations are to be done.
- 34.3. Service Provider is obliged to work closely with the Bank's staff, act within its own authority and abide by directives issued by the Bank from time to time and complete implementation activities.
- 34.4. Service Provider will abide by the job safety measures prevalent in India and will free the Bank from all demands or responsibilities arising from accidents or loss of life, the cause of which is Service Provider's negligence. Service Provider will pay all indemnities arising from such incidents and will not hold the Bank responsible or obligated.
- 34.5. Service Provider is responsible for activities of its personnel or sub-contracted personnel (where permitted) and will hold itself responsible for any misdemeanours.

34.6. If required by Bank, Vendor shall provide necessary training from the OEM to the designated SBI officials and / or its representative on the configuration, operation / functionalities, maintenance, support & administration for software / hardware and components, installation, troubleshooting processes of the proposed solution.

34.7. Service Provider shall treat as confidential all data and information about the Bank, obtained in the process of executing its responsibilities, in strict confidence and will not reveal such information to any other party without prior written approval of the Bank as explained under 'Non-Disclosure Agreement' in **Appendix-K** of this RFP.

### **35. TECHNICAL DOCUMENTATION:**

35.1. The Vendor shall deliver the following documents to the Bank for every firmware / software including third party software before software/ service become operational, which includes, user manuals, installation manuals, operation manuals, design documents, process documents, technical manuals, functional specification, software requirement specification, on-line tutorials / CBTs, system configuration documents, system/database administrative documents, debugging/diagnostics documents, test procedures etc.

35.2. Service Provider shall provide documents related to review records/ Test Bug Reports / Root Cause Analysis Report, list of all Product components, list of all dependent/external modules and list of all documents relating to traceability of service level failure as and when applicable.

35.3. Service Provider shall also provide the MIS reports as per requirements of the Bank. Any level/ version changes and/or clarification or corrections or modifications in the above-mentioned documentation should be supplied by Service Provider to the Bank, free of cost in timely manner.

### **36. INTELLECTUAL PROPERTY RIGHTS AND OWNERSHIP:**

36.1. For any technology / software / product used/supplied by Service Provider for performing Services for the Bank as part of this RFP, Service Provider shall have valid license to right to use as well as right to license such technology/ software / product. The Bank shall not be liable for any license or IPR violation on the part of Service Provider.

36.2. Without the Bank's prior written approval, Service provider will not, in performing the Services, use or incorporate link to or call or depend in any way upon, any software or other intellectual property that is subject to an Open Source or Copy left license or any other agreement that may give rise to any third-party claims or to limit the Bank's rights under this RFP.

36.3. Subject to clause 36.4 and 36.5 of this RFP, Service Provider shall, at its own expenses without any limitation, indemnify and keep fully and effectively indemnified the Bank against all costs, claims, damages, demands, expenses and liabilities whatsoever nature arising out of or in connection with all claims of infringement of Intellectual Property Right, including patent, trademark, copyright, trade secret or industrial design rights of any third party arising from the Services or use of the technology / software / products or any part thereof in India or abroad.

36.4. The Bank will give:

36.4.1. notice to Service Provider of any such claim without delay / provide reasonable assistance to Service Provider in disposing of the claim;

36.4.2. sole authority to defend and settle such claim and;

36.4.3. will at no time admit to any liability for or express any intent to settle the claim provided that:

36.4.3.1. Service Provider shall not partially settle any such claim without the written consent of the Bank, unless such settlement releases the Bank fully from such claim,

36.4.3.2. Service Provider shall promptly provide the Bank with copies of all pleadings or similar documents relating to any such claim,

36.4.3.3. Service Provider shall consult with the Bank with respect to the defence and settlement of any such claim, and

36.4.3.4. in any litigation to which the Bank is also a party, the Bank shall be entitled to be separately represented at its own expenses by counsel of its own selection.

36.5. Service Provider shall have no obligations with respect to any infringement claims to the extent that the infringement claim arises or results from: (i) Service Provider's compliance with the Bank's specific technical designs or instructions (except where Service Provider knew or should have known that such compliance was likely to result in an infringement claim and Service Provider did not inform the Bank of the same); or (ii) any unauthorized modification or alteration of the deliverable (if any) by the Bank.

36.6. Service provider agrees that the Bank owns the entire right, title and interest to any inventions, designs, discoveries, writings and works of authorship, including all intellectual property rights, copyrights. Any work made under this RFP shall

be deemed to be 'work made for hire' under any Indian/U.S. or any other applicable copyright laws.

36.7. The Intellectual Property Rights on the software code, copyright and source code for various applications/ interfaces developed under this RFP, and any other component/ framework/ middleware used/ developed as pre-built software assets to deliver the solution, shall belong to the Bank and the Bank shall have complete and unrestricted rights on such property. However, Service Provider shall hold All Intellectual Property rights in any pre-built software *per se*, except for those which have been assigned under this RFP.

36.8. All information processed by Service provider during software maintenance belongs to the Bank. Service provider shall not acquire any other right in respect of the information for the license to the rights owned by the Bank. Service provider will implement mutually agreed controls to protect the information. Service provider also agrees that it will protect the information appropriately.

### **37. LIQUIDATED DAMAGES:**

If Service Provider fails to deliver and perform any or all the Services within the stipulated time, schedule as specified in this RFP/Agreement, the Bank may, without prejudice to its other remedies under the RFP/Agreement, and unless otherwise extension of time is agreed upon without the application of liquidated damages, deduct from the Project Cost, as liquidated damages a sum equivalent to 0.5% of total Project Cost for delay of each week or part thereof maximum up to 5% of total Project Cost. Once the maximum deduction is reached, the Bank may consider termination of the Agreement.

### **38. CONFLICT OF INTEREST:**

38.1. Bidder shall not have a conflict of interest (the "Conflict of Interest") that affects the bidding Process. Any Bidder found to have a Conflict of Interest shall be disqualified. In the event of disqualification, the Bank shall be entitled to forfeit and appropriate the Bid Security and / or Performance Security (Bank Guarantee), as the case may be, as mutually agreed upon genuine estimated loss and damage likely to be suffered and incurred by the Bank and not by way of penalty for, inter alia, the time, cost and effort of the Bank, including consideration of such Bidder's proposal (the "Damages"), without prejudice to any other right or remedy that may be available to the Bank under the bidding Documents and/ or the Agreement or otherwise.

38.2. Without limiting the generality of the above, a Bidder shall be deemed to have a Conflict of Interest affecting the bidding Process, if:



- 38.2.1. the Bidder, its Member or Associate (or any constituent thereof) and any other Bidder, its Member or any Associate thereof (or any constituent thereof) have common controlling shareholders or other ownership interest; provided that this disqualification shall not apply in cases where the direct or indirect shareholding of a Bidder, its Member or an Associate thereof (or any shareholder thereof having a shareholding of more than 5% (five per cent) of the paid up and subscribed share capital of such Bidder, Member or Associate, as the case may be) in the other Bidder, its Member or Associate, has less than 5% (five per cent) of the subscribed and paid up equity share capital thereof; provided further that this disqualification shall not apply to any ownership by a bank, insurance company, pension fund or a public financial institution referred to in section 2(72) of the Companies Act, 2013. For the purposes of this Clause, indirect shareholding held through one or more intermediate persons shall be computed as follows: (aa) where any intermediary is controlled by a person through management control or otherwise, the entire shareholding held by such controlled intermediary in any other person (the "Subject Person") shall be taken into account for computing the shareholding of such controlling person in the Subject Person; and (bb) subject always to sub-clause (aa) above, where a person does not exercise control over an intermediary, which has shareholding in the Subject Person, the computation of indirect shareholding of such person in the Subject Person shall be undertaken on a proportionate basis; provided, however, that no such shareholding shall be reckoned under this sub-clause if the shareholding of such person in the intermediary is less than 26% of the subscribed and paid up equity shareholding of such intermediary; or
- 38.2.2. a constituent of such Bidder is also a constituent of another Bidder; or
- 38.2.3. such Bidder, its Member or any Associate thereof receives or has received any direct or indirect subsidy, grant, concessional loan or subordinated debt from any other Bidder, its Member or Associate, or has provided any such subsidy, grant, concessional loan or subordinated debt to any other Bidder, its Member or any Associate thereof; or
- 38.2.4. such Bidder has the same legal representative for purposes of this Bid as any other Bidder; or
- 38.2.5. such Bidder, or any Associate thereof, has a relationship with another Bidder, or any Associate thereof, directly or through common third party/parties, that puts either or both of them in a position to have access to each other's information about, or to influence the Bid of either or each other; or
- 38.2.6. such Bidder or any of its affiliates thereof has participated as a consultant to the Bank in the preparation of any documents, design or technical specifications of the RFP.

38.3. For the purposes of this RFP, Associate means, in relation to the Bidder, a person who controls, is controlled by, or is under the common control with such Bidder (the "Associate"). As used in this definition, the expression "control" means, with respect to a person which is a company or corporation, the ownership, directly or indirectly, of more than 50% (fifty per cent) of the voting shares of such person, and with respect to a person which is not a company or corporation, the power to direct the management and policies of such person by operation of law or by contract.

### **39. CODE OF INTEGRITY AND DEBARMENT / BANNING: -**

39.1. The Bidder and their respective officers, employees, agents and advisers shall observe the highest standard of ethics during the bidding Process. Notwithstanding anything to the contrary contained herein, the Bank shall reject Bid without being liable in any manner whatsoever to the Bidder if it determines that the Bidder has, directly or indirectly or through an agent, engaged in corrupt/fraudulent/coercive/undesirable or restrictive practices in the bidding Process.

39.2. Bidders are obliged under code of integrity to Suo-moto proactively declare any conflicts of interest (pre-existing or as and as soon as these arise at any stage) in RFP process or execution of contract. Failure to do so would amount to violation of this code of integrity.

39.3. Any Bidder needs to declare any previous transgressions of such a code of integrity with any entity in any country during the last three years or of being debarred by any other procuring entity. Failure to do so would amount to violation of this code of integrity.

39.4. For the purposes of this clause, the following terms shall have the meaning hereinafter, respectively assigned to them:

39.4.1. **"Corrupt practice"** means making offers, solicitation or acceptance of bribe, rewards or gifts or any material benefit, in exchange for an unfair advantage in the procurement process or to otherwise influence the procurement process or contract execution;

39.4.2. **"Fraudulent practice"** means any omission or misrepresentation that may mislead or attempt to mislead so that financial or other benefits may be obtained, or an obligation avoided. This includes making false declaration or providing false information for participation in an RFP process or to secure a contract or in execution of the contract;

- 39.4.3. **“Coercive practice”** means harming or threatening to harm, persons or their property to influence their participation in the procurement process or affect the execution of a contract;
- 39.4.4. **“Anti-competitive practice”** means any collusion, bid rigging or anti-competitive arrangement, or any other practice coming under the purview of the Competition Act, 2002, between two or more bidders, with or without the knowledge of the Bank, that may impair the transparency, fairness and the progress of the procurement process or to establish bid prices at artificial, non-competitive levels;
- 39.4.5. **“Obstructive practice”** means materially impede the Bank’s or Government agencies investigation into allegations of one or more of the above mentioned prohibited practices either by deliberately destroying, falsifying, altering; or by concealing of evidence material to the investigation; or by making false statements to investigators and/or by threatening, harassing or intimidating any party to prevent it from disclosing its knowledge of matters relevant to the investigation or from pursuing the investigation; or by impeding the Bank’s rights of audit or access to information;

### **39.5. Debarment / Banning**

Empanelment/participation of Bidders and their eligibility to participate in the Bank’s procurements is subject to compliance with code of integrity and performance in contracts as per terms and conditions of contracts. Following grades of debarment from empanelment/participation in the Bank’s procurement process shall be considered against delinquent Vendors / Bidders: -

#### **39.5.1 Holiday Listing (Temporary Debarment - suspension):**

Whenever a Vendor is found lacking in performance, in case of less frequent and less serious misdemeanours, the vendors may be put on a holiday listing (temporary debarment) for a period upto 12 (twelve) months. When a Vendor is on the holiday listing, he is neither invited to bid nor are his bids considered for evaluation during the period of the holiday. The Vendor is, however, not removed from the list of empanelled vendors, if any. Performance issues which may justify holiday listing of the Vendor are:

- Vendors who have not responded to requests for quotation/tenders consecutively three times without furnishing valid reasons, if mandated in the empanelment contract (if applicable);

- Non-performance or performance below specified standards (under the scope of work of this RFP)
- Vendors undergoing process for removal from empanelment/participation in procurement process or banning/debarment may also be put on a holiday listing during such proceedings.

### **39.5.2 Debarment from participation including removal from empanelled list:**

Debarment of a delinquent Vendor (including their related entities) for a period (one to two years) from the Bank's procurements including removal from empanelment, wherever such Vendor is empanelled, due to severe deficiencies in performance or other serious transgressions. Reasons which may justify debarment and/or removal of the Vendor from the list of empanelled vendors are:

- Without prejudice to the rights of the Bank under Clause 39.1 hereinabove, if a Bidder is found by the Bank to have directly or indirectly or through an agent, engaged or indulged in any corrupt/fraudulent/coercive/undesirable or restrictive practices during the bidding Process, such Bidder shall not be eligible to participate in any EOI / RFP issued by the Bank during a period of 2 (two) years from the date of debarment.
- Vendor fails to abide by the any terms and conditions of this RFP or to maintain the required technical/operational staff/equipment or there is change in its production/service line affecting its performance adversely, or fails to cooperate or qualify in the review for empanelment;
- If Vendor ceases to exist or ceases to operate in the category of requirements for which it is empanelled;
- Bankruptcy or insolvency on the part of the vendor as declared by a court of law; or
- Banning by Ministry/Department or any other Government agency;
- Other than in situations of force majeure, technically qualified Bidder withdraws from the procurement process or after being declared as successful bidder: (i) withdraws from the process; (ii) fails to enter into a Contract; or (iii) fails to provide performance guarantee or any other document or security required in terms of the RFP documents;
- If the Central Bureau of Investigation/CVC/C&AG or Vigilance Department of the Bank or any other investigating agency recommends such a course in respect of a case under investigation;

- Employs a Government servant or the Bank's Officer within two years of his retirement, who has had business dealings with him in an official capacity before retirement; or
- Any other ground, based on which the Bank considers, that continuation of Contract is not in public interest.
- If there is strong justification for believing that the partners/directors/proprietor/agents of the firm/company have been guilty of violation of the code of integrity or Integrity Pact (wherever applicable), evasion or habitual default in payment of any tax levied by law; etc.

### **39.5.3 Banning from Ministry/Country-wide procurements**

For serious transgression of code of integrity, a delinquent Vendor (including their related entities) may be banned/debarred from participation in a procurement process of the Bank including procurement process of any procuring entity of Government of India for a period not exceeding three years commencing from the date of debarment.

## **40. TERMINATION FOR DEFAULT:**

40.1. The Bank, without prejudice to any other remedy for breach of contract, shall have the right to terminate the contract in whole or part, at any time by giving a written notice of 30 days to the Service Provider,

40.1.1. if Service Provider fails to deliver any or all the obligations within the time period(s) specified in the RFP / Agreement, or any extension thereof granted by the Bank;

40.1.2. If Service Provider fails to perform any other obligation(s) under the RFP / Agreement;

40.1.3. Violations of any terms and conditions stipulated in the RFP;

40.1.4. On happening of any termination event mentioned in the RFP / Agreement

Prior to providing a written notice of termination to Service Provider under clause 40.1.1 to 40.1.3, the Bank shall provide Service Provider with a written notice of 60 (sixty) days to cure such breach of the Agreement. If the breach continues or remains unrectified after expiry of cure period, the Bank shall have right to initiate action in accordance with above clause.

- 40.2. In the event the Bank terminates the Contract in whole or in part for the breaches attributable to Service Provider, the Bank may procure, upon such terms and in such manner as it deems appropriate, Services similar to those undelivered, and subject to limitation of liability clause of this RFP Service Provider shall be liable to the Bank for any increase in cost for such similar Services. However, Service Provider shall continue performance of the Contract to the extent not terminated.
- 40.3. If the Contract is terminated under any termination clause, Service Provider shall handover all documents/ executable/ Bank's data or any other relevant information to the Bank in timely manner and in proper format as per scope of this RFP and shall also support the orderly transition to another vendor or to the Bank.
- 40.4. During the transition, Service Provider shall also support the Bank on technical queries / support on process implementation.
- 40.5. The Bank's right to terminate the Contract will be in addition to the penalties / liquidated damages and other actions as specified in this RFP.
- 40.6. In the event of failure of Service Provider to render the Services or in the event of termination of Agreement or expiry of term or otherwise, without prejudice to any other right, the Bank at its sole discretion may make alternate arrangement for getting the Services contracted with another vendor. In such case, the Bank shall give prior notice to the existing Service Provider. The existing Service Provider shall continue to provide services as per the terms of the Agreement until a 'New Service Provider' completely takes over the work. During the transition phase, the existing Service Provider shall render all reasonable assistance to the new Service Provider within such period prescribed by the Bank, at no extra cost to the Bank, for ensuring smooth switch over and continuity of services, provided where transition services are required by the Bank or New Service Provider beyond the term of this Agreement, reasons for which are not attributable to Service Provider, payment shall be made to Service Provider for such additional period on the same rates and payment terms as specified in this Agreement. If existing Service Provider is breach of this obligation, they shall be liable for paying a penalty of 10% of the total Project Cost on demand to the Bank, which may be settled from the payment of invoices or Bank Guarantee for the contracted period or by invocation of Bank Guarantee, or by any other means deemed fit by bank as per its sole discretion.
- 40.7. ~~The Machine Site, for all practical purposes, belongs to the Bank.~~ Service Provider will, ~~therefore,~~ not transfer / sell / surrender / vacate the Site or / and enter into any contract / order / agreement with any other Bank / entity

for the Site without Bank's permission. The Bank will also have the first right of refusal for the Site on termination / expiry of SLA.

40.8. During the concurrency of the contract and extension thereof, if any Service Provider is non-compliant to any of the terms and conditions of the RFP / SLA at any stage of RFP or in any year of contract period and is not curable (within the stipulated time) shall lead to termination, and that terminated vendor's allocated proportion shall be distributed one or / and among the remaining successful vendors as per allocation ratio decided by the Bank and shall be binding to remaining vendors.

#### **41. FORCE MAJEURE:**

41.1. Notwithstanding the provisions of terms and conditions contained in this RFP, neither party shall be liable for any delay in performing its obligations herein if and to the extent that such delay is the result of an event of Force Majeure.

41.2. For the purposes of this clause, 'Force Majeure' means and includes wars, insurrections, revolution, civil disturbance, riots, terrorist acts, public strikes, hartal, bundh, fires, floods, epidemic, quarantine restrictions, freight embargoes, declared general strikes in relevant industries, Vis Major, acts of Government in their sovereign capacity, Curfew or Lockdowns by notification of the State / District Govts impeding reasonable performance of Service Provider and / or Sub-Contractor but does not include any foreseeable events, commercial considerations or those involving fault or negligence on the part of the party claiming Force Majeure.

41.3. If a Force Majeure situation arises, Service Provider shall promptly notify the Bank in writing of such condition and the cause thereof. Unless otherwise directed by the Bank in writing, Service Provider shall continue to perform its obligations under the Contract as far as is reasonably practical and shall seek all reasonable alternative means for performance not prevented by the Force Majeure event.

#### **42. TERMINATION FOR INSOLVENCY:**

42.1. The Bank may, at any time, terminate the Contract by giving written notice to Service Provider, if Service Provider becomes Bankrupt or insolvent or any application for bankruptcy, insolvency or winding up has been filed against it by any person. In this event, termination will be without compensation to Service Provider, provided that such termination will not prejudice or affect any right of action or remedy, which has accrued or will accrue thereafter to the Bank.

42.2. ~~The Machine Site, for all practical purposes, belongs to the Bank.~~ Service Provider will, ~~therefore~~, not transfer / sell / surrender / vacate the Site or / and enter into any contract / order / agreement with any other Bank / entity for the Site without Bank's permission. The Bank will also have the first right of refusal for the Site on termination / expiry of SLA.

#### **43. TERMINATION FOR CONVENIENCE:**

43.1. The Bank, by written notice of not less than 90 (ninety) days, may terminate the Contract, in whole or in part, for its convenience, provided same shall not be invoked by the Bank before completion of half of the total Contract period (including the notice period).

43.2. In the event of termination of the Agreement for the Bank's convenience, Service Provider shall be entitled to receive payment for the Services rendered (delivered) up to the effective date of termination.

43.3. ~~The Machine Site, for all practical purposes, belongs to the Bank.~~ Service Provider will, ~~therefore~~, not transfer / sell / surrender / vacate the Site or / and enter into any contract / order / agreement with any other Bank / entity for the Site without Bank's permission. The Bank will also have the first right of refusal for the Site on termination / expiry of SLA.

#### **44. DISPUTES / ARBITRATION (APPLICABLE IN CASE OF SUCCESSFUL BIDDER ONLY):**

44.1. All disputes or differences whatsoever arising between the parties out of or in connection with the Contract (including dispute concerning interpretation) or in discharge of any obligation arising out of the Contract (whether during the progress of work or after completion of such work and whether before or after the termination of the Contract, abandonment or breach of the Contract), shall be settled amicably. If however, the parties are not able to solve them amicably within 30 (thirty) days after dispute occurs as evidenced through the first written communication from any Party notifying the other regarding the disputes, either party (SBI or Service Provider), give written notice to other party clearly setting out there in specific dispute(s) and/or difference(s) and shall be referred to a sole arbitrator mutually agreed upon, and the award made in pursuance thereof shall be binding on the parties. In the absence of consensus about the single arbitrator, the dispute may be referred to an arbitration panel; one to be nominated by each party and the said arbitrators shall nominate a presiding arbitrator, before commencing the arbitration proceedings. The arbitration shall



be settled in accordance with the applicable Indian Laws and arbitration proceeding shall be conducted in accordance with Arbitration and Conciliation Act 1996 and any amendment thereto. Any appeal will be subject to the exclusive jurisdiction of courts at Mumbai.

44.2. Service Provider shall continue work under the Contract during the arbitration proceedings unless otherwise directed by the Bank or unless the matter is such that the work cannot possibly be continued until the decision of the arbitrator is obtained.

44.3. Arbitration proceeding shall be held at Mumbai, India, and the language of the arbitration proceedings and that of all documents and communications between the parties shall be in English.

#### **45. GOVERNING LANGUAGE:**

The governing language shall be English.

#### **46. APPLICABLE LAW:**

The Contract shall be interpreted in accordance with the laws of the Union of India and shall be subjected to the exclusive jurisdiction of courts at Mumbai.

#### **47. TAXES AND DUTIES:**

47.1. Service Provider shall be liable to pay all corporate taxes and income tax that shall be levied according to the laws and regulations applicable from time to time in India and the price Bid by Service Provider shall include all such taxes in the quoted price.

47.2. Prices quoted should be exclusive of all Central / State Government taxes/duties and levies but inclusive of all corporate taxes and Custom duty as also cost of incidental services such as transportation, road permits, insurance etc. The quoted prices and taxes / duties and statutory levies such as GST etc. should be specified in the separate sheet (**Appendix-F**).

47.3. Custom duty as also cost of incidental services such as transportation, road permits, insurance etc. in connection with delivery of products at site including any incidental services and commissioning, if any, which may be levied, shall be borne by Service Provider and the Bank shall not be liable for the same. Only specified taxes/ levies and duties in the **Appendix-F** will be payable by the Bank on actuals upon production of original receipt wherever required. If

any specified taxes/ levies and duties in **Appendix-F** are replaced by the new legislation of Government, same shall be borne by the Bank. The Bank shall not be liable for payment of those Central / State Government taxes, levies, duties or any tax/ duties imposed by local bodies/ authorities, which are not specified by the Bidder in **Appendix-F**

47.4. Prices payable to Service Provider as stated in the Contract shall be firm and not subject to adjustment during performance of the Contract, irrespective of reasons whatsoever, including exchange rate fluctuations, any upward revision in Custom duty.

47.5. Income / Corporate Taxes in India: The Bidder shall be liable to pay all corporate taxes and income tax that shall be levied according to the laws and regulations applicable from time to time in India and the price Bid by the Bidder shall include all such taxes in the contract price.

47.6. All expenses, stamp duty and other charges/ expenses in connection with the execution of the Agreement and all Addenda / Extension Addendum to the Agreement as a result of this RFP process shall be borne by Service Provider. The Agreement/ Contract would be stamped as per Maharashtra Stamp Act, 1958 and any amendment thereto.

#### **48. TAX DEDUCTION AT SOURCE:**

48.1. Wherever the laws and regulations require deduction of such taxes at the source of payment, the Bank shall effect such deductions from the payment due to Service Provider. The remittance of amounts so deducted and issuance of certificate for such deductions shall be made by the Bank as per the laws and regulations for the time being in force. Nothing in the Contract shall relieve Service Provider from his responsibility to pay any tax that may be levied in India on income and profits made by Service Provider in respect of this Contract.

48.2. Service Provider's staff, personnel and labour will be liable to pay personal income taxes in India in respect of such of their salaries and wages as are chargeable under the laws and regulations for the time being in force, and Service Provider shall perform such duties in regard to such deductions thereof as may be imposed on him by such laws and regulations.

#### **49. TENDER FEE:**

Non-refundable Tender Fee should be furnished by the Bidders as stated in schedule of events. The Bids without tender fee will not be considered valid.

## **50. EXEMPTION OF EMD AND TENDER FEE:**

50.1. Micro & Small Enterprises (MSE) units and Start-ups (subject to clause 50.3.3 below) are exempted from payment of EMD and tender fee provided the Services they are offering, are rendered by them. Exemption as stated above is not applicable for providing services, rendered by other companies.

50.2. Bidder should submit supporting documents issued by competent Govt. bodies to become eligible for the relaxations to Micro & Small Enterprises (MSE) and Start-ups under this RPF.

### **50.3. Bidders may please note:**

50.3.1. NSIC certificate/ Udyog Aadhar Memorandum / Udyam Registration Certificate should cover the items tendered to get EMD/tender fee exemptions. Certificate/ Memorandum should be valid as on due date / extended due date for Bid submission.

50.3.2. "Start-up" company should enclose the valid Certificate of Recognition issued by Department for Promotion of Industry and Internal Trade (DPIIT), (erstwhile Department of Industrial Policy and Promotion), Ministry of Commerce & Industry, Govt. of India with the technical bid.

50.3.3. Start-ups which are not under the category of MSE shall not be eligible for exemption of tender fee.

50.3.4. Bidder who solely on its own, fulfils each eligibility criteria condition as per the RFP terms and conditions and who are having MSE or Start-up company status, can claim exemption for EMD/ tender fee.

50.3.5. If all these conditions are not fulfilled or supporting documents are not submitted with the technical Bid, then all those Bids without tender fees /EMD will be summarily rejected and no queries will be entertained.

## **51. NOTICES and OTHER TERMS & CONDITIONS:**

51.1. Any notice given by one party to the other pursuant to this Contract shall be sent to other party in writing and confirmed in writing to other Party's address. The notice shall be effective when delivered or on the notice's effective date whichever is later.

### **51.2. Selected Bidder's Obligations:**

51.2.1. If the proposal includes machine / equipment or software marketed and / or supported by other companies or individuals, the selected bidder, as the

prime contractor for the delivery, testing, installation and maintenance of the entire system, must ensure and declare that they possess the requisite permission / license for the machine / equipment / software. Also, the selected bidder commits to support / repair / replace / maintain all parts of the Endpoint, irrespective of the position whether the parts are manufactured by the Bidder or outsourced by them.

- 51.2.2. The Bidder is responsible for and obliged to conduct all contracted activities in accordance with the contract using state-of-the-art methods and economic principles and exercising all means available to achieve the performance specified in Contract.
- 51.2.3. The bidder will be responsible for arranging and procuring all relevant permissions / Road Permits etc. for transportation of the machine to the location where installation is to be done. The Bank would only provide necessary letters for enabling procurement of the same.
- 51.2.4. The Bidder is obliged to work closely with the Bank's staff, act within its own authority and abide by directives issued by the Bank and implementation activities.
- 51.2.5. The Bidder will abide by the job safety measures prevalent in India and will free the Bank from all demands or responsibilities arising from accidents or loss of life, the cause of which is the Bidder's negligence.
- 51.2.6. The Bidder is responsible for managing the activities of its personnel or sub-contracted personnel and will hold itself responsible for any misdemeanors.
- 51.2.7. The Selected bidder(s) shall be responsible for compliance with all laws, rules, regulations, orders, notifications, and directions applicable in respect of its personnel (including, but not limited to, the Contract Labour (Prohibition and Regulation) Act 1986, the Payment of Bonuses Act 1965, the Minimum Wages Act 1948, the Employees' Provident Fund Act 1952, and the Workmen's Compensation Act 1923,) and shall maintain all proper records, including, but not limited to, accounting records required under the Applicable Laws, or any code, practice or corporate policy applicable to it from time to time.

## **52. ASSIGNMENT**

- 52.1. Service Provider shall not transfer or assign at any stage, during the currency of the contract and extension thereof, any of its duties, responsibilities, obligations and benefits of this agreement to any third party / financial institution / entity without the prior written consent of the Bank.,

52.2. Bank can transfer or assign any service or all services under contract at any stage to an Affiliate / subsidiary /Joint Venture etc. during the currency of contract and inform to the vendors.

### **53. INDEMNITY**

53.1 The Vendor hereby indemnifies the Bank, and shall always keep indemnified and hold the Bank, its employees, personnel, directors, (hereinafter collectively referred to as "Personnel") harmless from and against any and all losses, liabilities, claims, actions, costs and expenses (including attorneys' fees) awarded against the Bank relating to, resulting directly from or arising out of any claim, suit or proceeding brought against the Bank, as a result of:

- 53.1.1. Bank's bona fide use of the Deliverables and / or the Services provided by Vendor under this RFP; and / or
- 53.1.2. an act or omission of the Vendor, its employees, agents, sub-contractors in the performance of the obligations of the Vendor in breach of the terms & conditions of the RFP / SLA; and / or
- 53.1.3. claims made by employees or sub-contractors or sub-contractors' employees, who are deployed by the Vendor, against the Bank; and / or
- 53.1.4. any lease arrangement / rental arrangement / finance or loan arrangement in respect of or in relation to the Deliverables and Services provided under this RFP;
- 53.1.5. breach of any of the term of this Agreement or breach of any representation or false representation or inaccurate statement or assurance or covenant or warranty by the Vendor under this RFP; and/or
- 53.1.6. any or all Deliverables or Services infringing any patent, trademarks, copyrights or such other Intellectual Property Rights; and/or
- 53.1.7. breach of confidentiality obligations of the Vendor contained in this RFP; and / or
- 53.1.8. Gross negligence attributable to the Vendor or its employees or sub-contractors; and / or
- 53.1.9. Any action taken, claims or fines imposed on Bank by any Government, statutory or regulatory authorities due to an act or omission on the part of the Vendor, which acts or omission in breach of this Agreement; and / or
- 53.1.10. Any loss on account of any skimming, shimming or keypad-related fraud committed on the CDs attributable to the manufacturing defect in the CDs and specifically excluding frauds committed by using cards obtained/processed fraudulently outside the purview of reasonable control of the Vendor; and / or
- 53.1.11. Any cash replenishment shortages committed by any employee of the Vendor and/or CMA engaged by Vendor; and / or

- 53.1.12. Any losses, damages, costs incurred by the Bank on account of any third party claims due to any fault, imperfection on the equipment provided by the Vendor under this RFP; and / or
- 53.1.13. Fraud committed by the Vendors or its representatives resulting in Bank's image getting tarnished. The claim made by Bank in this regard shall be final and binding upon Vendor even though they have made good the monetary loss to the Bank.
- 53.2 The Vendor shall at its own cost and expenses defend or settle any claim against the Bank including that the Deliverables and Services delivered or provided under this RFP infringe a patent, utility model, industrial design, copyright, trade secret, mask work or trademark.
- 53.3 Vendor and / or its sub-contractors shall undertake thorough background check, due diligence in verifying the antecedents of its employees and shall indemnify and protect the Bank against all claims, losses, costs, damages, expenses, action suits and other proceedings resulting from any action of its employees or agents and / or third party. In the event any such claim or legal action is initiated against the Bank by the employees/agents of Vendor or of the subcontractor's employees/agent and / or by any agent/employee of any agency engaged by the Vendor for providing any services including security arrangements and / or third party, the Vendor shall immediately implead itself in such proceedings, contest or settle the matter at its costs. In any way the Vendor shall ensure that Bank is removed from the array of Defendants immediately. All costs and expenses including counsel fee shall be borne by the Vendor and the Bank shall be kept fully Indemnified in this regard by the Vendor.
- 53.4 During the contract period, Vendor and its outsourced agents shall comply with all statutory, regulatory provisions, relevant laws, guidelines, advisories etc, time to time framed by the Central Government / State Government / Local Bodies / RBI / MHA or any other statutory authority (s), including but not limited to Shops & Establishment Act, Minimum Wages Act, Contract Labour, Tax laws, all laws pertaining to contract employees required for providing the Services including Caretaker Services etc. and undertakes to keep the Bank indemnified against any such default (s) of his obligations under the compliance of such laws during the full contract period.
- 53.5 The Vendor's indemnity to the Bank under this Agreement is based on the Bank (i) providing prompt written notice to the Vendor of the event giving rise to indemnity claim; (ii) granting authority to the Vendor to defend or settle any action or claim covered by indemnity if the Vendor chooses to defend the case; (iii) providing at Vendor's expense, such information, cooperation and assistance to Vendor as may be reasonably necessary for the Vendor

to defend or settle the claim or action; (iv) not taking any action that will prejudice Vendor's interests; and (v) taking all reasonable measures to mitigate the loss or damage caused due to the event giving rise to indemnity claim against the Vendor.

53.6 Neither Party shall be liable to the other for any special, indirect, incidental, consequential (including loss of profit or revenue), exemplary or punitive damages, whether in contract, tort or other theories of law, even if such Party has been advised of the possibility of such damages.

53.7 Limitation of Liability: The total cumulative liability of the vendor arising from or relating to this Agreement shall not exceed the total amount payable to the Vendor by the Bank for the contract period. Provided however, this limitation shall not apply to any liability or damages arising from (a) willful misconduct of the Vendor; (b) indemnification against third party claims for infringement; (c) breach of confidentiality obligations; (d) loss of Bank's Cash held in ATM / CD, in Transit and / or in Vault held by the Vendor or any agency engaged by the Vendor.

**54. COMPLIANCE WITH IS SECURITY POLICY:  
(This list is illustrative only and not exhaustive. Detailed guidelines shall be shared with successful bidders)**

The Vendor shall have to comply with Bank's IT & IS Security policy in key concern areas relevant to the RFP, details of which will be shared with the finally selected Bidder. Some of the key areas are as under:

- 54.1 Responsibilities for data and application privacy and confidentiality.
- 54.2 Responsibilities on system and software access control and administration
- 54.3 Custodial responsibilities for data, software, hardware and other assets of the Bank being managed by or assigned to the Vendor
- 54.4 Physical Security of the facilities
- 54.5 Physical and logical separation from other customers of the Vendor
- 54.6 Incident response and reporting procedures
- 54.7 Password Policy of the Bank
- 54.8 Data Encryption/Protection requirements of the Bank.
- 54.9 In general, confidentiality, integrity and availability must be ensured.
- 54.10 All data are confidential and should not be disclosed to any external parties ever.
- 54.11 Bidders need to comply with other existing and future policies/SOPs of the Bank related to logs/ ATM operations/Governance etc. In addition, bidder is required to address the observations of various audits/examinations of Regulator as and when advised in the stipulated timeline.

54.12 At the end of the project, after sharing all the Bank's data with the Bank, all the bank's data must be completely erased by using tools like disk eraser by the vendor. The vendor and its deployed resources should certify and confirm the Bank that all data associated with the project has been deleted from their laptops/PCs/email/cloud drives etc.

54.13 Whatever data the consultancy firm is having in their hard disk etc. related to the project, the same should be destroyed or returned to Bank. At the end of the project the consultancy firm to confirm that they are not having any data on account of this project. If the Bank requires the services of the Consultancy firm after project is completed, the Bank shall share the required data with the firm. Office copies of the papers delivered to the Bank may be retained, subject to confidentiality obligation and should be destroyed within a reasonable period.

54.14 Vendor to meticulously follow following control measures -

**CONTROLS TO BE IMPLEMENTED BY THIRD PARTIES AND TO BE MONITORED BY IT APPLICATION OWNER**

SN	Controls to be implemented	Compliance (Yes/No)
1	Whether the 3rd party has Information security policy in place with periodic reviews?	
2	Whether the 3rd party have operational processes with periodic review, including but not limited to: <ul style="list-style-type: none"> <li>• Business Continuity Management</li> <li>• Backup management</li> <li>• Desktop/system/server/network device hardening with baseline controls</li> <li>• Patch Management</li> <li>• Port Management</li> <li>• Media Movement</li> <li>• Log Management</li> <li>• Personnel Security</li> <li>• Physical Security</li> <li>• Internal security assessment processes</li> </ul>	
3	Whether a proper documented change management process has been instituted by the 3rd party?	
4	Whether the 3rd party has a documented policy and process of Incident management /response?	



SN	Controls to be implemented	Compliance (Yes/No)
5	Whether the 3rd party's environment is suitably protected from external threats by way of firewall, WAF, IDS/IPS, AD, AV, NAC, DLP etc.?	
6	Whether rules are implemented on Firewalls of the 3rd party environment as per an approved process?	
7	Whether firewall rule position is regularly monitored for presence of any vulnerable open port or any-any rule?	
8	Whether proper log generation, storage, management and analysis happens for the 3rd party application?	
9	Is the 3rd party maintaining all Web, application, DB, Configuration and user access logs for forensic readiness?	
10	Whether the 3rd party maintains logs for privileged access to their critical systems?	
11	Whether privilege access to the 3rd party environment is permitted from internet?	
12	Whether the 3rd party has captive SOC or Managed Service SOC for monitoring their systems and operations?	
13	Whether the 3rd party environment is segregated into militarized zone (MZ) and demilitarized zone (DMZ) separated by Firewall, where any access from an external entity is permitted through DMZ only?	
14	Whether 3rd party has deployed secure production, disaster recovery and testing environments for their application?	
15	Whether the 3rd party follows the best practices of creation of separate network zones (VLAN Segments) for Web, App, DB and different zones for critical applications, non-critical applications, UAT etc.?	
16	Whether the 3rd party configures access to officials based on a documented and approved Role Conflict Matrix?	
17	Whether Internet access is permitted on internal servers, database servers etc.?	
18	Whether the 3rd party has deployed a dedicated information security team independent of IT, reporting directly to MD/CIO for conducting security related functions & operations?	
19	Whether CERTIN Empanelled ISSPs are engaged by the third party for ensuring security posture of their application?	
20	Whether quarterly vulnerability assessment and penetration testing is being done by the 3rd party for their infrastructure?	
21	Whether suitable Security certifications (ISO, PCI-DSS etc.) of the security posture at vendor environment are in place?	

22	Whether the 3rd party has deployed any open source or free software in their environment? If yes, whether security review has been done for such software?	
23	Whether the data shared with the 3rd party is owned by SBI (SBI = Information Owner)?	
24	Whether the data shared with the 3rd party is of sensitive nature?	
25	Whether the requirement and the data fields to be stored by the 3rd party is approved by Information Owner?	
26	Where shared, whether the bare minimum data only is being shared? (Please document the NEED for sharing every data field)	
27	Whether the data to be shared with 3rd party will be encrypted as per industry best standards with robust key management?	
28	Whether the 3rd party is required to store the data owned by State Bank?	
29	Whether any data which is permitted to be stored by the 3rd party will be completely erased after processing by the 3rd party at their end?	
30	Whether the data shared with the 3rd party is stored with encryption (Data at rest encryption)?	
31	Whether the data storage technology (Servers /Public Cloud/ Tapes etc.) has been appropriately reviewed by IT AO?	
32	Whether the 3rd party is required to share SBI specific data to any other party for any purpose?	
33	Whether a system of obtaining approval by the 3rd party from the IT Application Owner is put in place before carrying out any changes?	
34	Whether 3rd party is permitted to take any crucial decisions on behalf of SBI without written approval from IT Application Owner? If not, are such instances being monitored? IT Application Owner to describe the system of monitoring such instances.	
35	Whether Application Owner has verified that the 3rd party has implemented efficient and sufficient preventive controls to protect SBI's interests against any damage under section 43 of IT Act?	
36	Whether the selection criteria for awarding the work to 3rd party vendor is based on the quality of service?	

37	<p>Whether the SLA/agreement between SBI and the 3rd party contains the following clauses:</p> <ul style="list-style-type: none"> <li>• Right to Audit to SBI with scope defined</li> <li>• Adherence by the vendor to SBI Information Security requirements including regular reviews, change management, port management, patch management, backup management, access management, log management etc.</li> <li>• Right to recall data by SBI.</li> <li>• Regulatory and Statutory compliance at vendor site. Special emphasis on section 43A of IT Act 2000 apart from others.</li> <li>• Availability of Compensation clause in case of any data breach or incident resulting into any type of loss to SBI, due to vendor negligence.</li> <li>• No Sharing of data with any third party without explicit written permission from competent Information Owner of the Bank including the Law Enforcement Agencies.</li> </ul>	
38	<p>Whether the residual risk has been covered by transferring the technology risk to Legal risk by incorporating suitable legal terms in SLA</p>	

**55. CONTRADICTION BETWEEN RFP / SLA:**

In case of any contradiction between or among them the priority in which a document would prevail over another would be as laid down below beginning from the highest priority to the lowest priority:

- (i) The executed Service Level Agreement (SLA);
- (ii) Annexure of Agreement (SLA);
- (iii) Purchase Order issued; and
- (iv) RFP and amendments hereto

Clauses written in any of the above documents stand valid for the procurement project for the entire contract period and extensions thereof.

**56. SYSTEM INTEGRATION TESTING:**

The Vendor should integrate the software with the existing systems as per requirement of the Bank and carry out thorough System Integration Testing (SIT).

System integration testing will be followed by user acceptance testing (UAT), plan for which should be submitted by the Vendor to the Bank. The UAT includes functional tests, resilience tests, benchmark comparisons, operational tests, load tests etc. SBI staff / third Party Vendor designated by the Bank will carry out the functional testing. This staff / third party vendor will need necessary on-site training for the purpose and should be provided by the Vendor. Vendor should carry out other testing like resiliency / benchmarking / load etc. Vendor should submit result log for

all testing to the Bank. On satisfactory completion of the afore mentioned tests and ISD Clearance and pilot, successful commission and acceptance of solution letter will be issued to the vendor by the competent authority.

**57. CHANGE IN ORDERS:**

The Bank may, at any time, by a written order given to the Vendor, make changes within the scope of the work and any other part of Contract as per bank business requirement and it shall be binding to the bidder.

**58. COUNTRY OF ORIGIN / ELIGIBILITY OF PRODUCTS & SERVICES:**

58.1. All Products and components thereof to be supplied under the Contract shall have their origin in eligible source countries, as per the prevailing import trade control regulations in India. For purposes of this clause, "origin" means the place where the Products are mined, grown, or manufactured or produced, or the place from which the related product is supplied. Products are produced when, through manufacturing, processing or substantial and major assembly of components, a commercially recognized product results that is substantially different in basic characteristics or in purpose or utility from its components.

58.2. **The Bidder / Vendor shall not provide / supply / use any banned imported goods / items and services of the restricted / prohibited items. Such BAN / prohibitions / restrictions are imposed by Gol or / and any Statutory Authority(ies) / Law enforcement agency(ies).**

**APPENDIX-A**  
**BID FORM (TECHNICAL BID)**

[On Company's letter head]  
(To be included in Technical Bid)

Date: DD/MMM/YYYY

To:

**The Deputy General Manager (I&R),  
State Bank of India,  
Corporate Centre,  
Anytime Channels Dept.,  
3<sup>rd</sup> Floor, World Trade Centre "Arcade",  
Cuffe Parade, Mumbai – 400005.**

Dear Sir,

**Ref: RFP No. SBI/AC/2023-24/003 dated: 17/08/2023.**

We have examined the above RFP with its corrigendum(a), if any, the receipt of which is hereby duly acknowledged and subsequent pre-bid clarifications / modifications / revisions, if any, furnished by the Bank and we offer to provide services / items detailed in this RFP under Total Outsourced Model (TOM). We shall abide by the terms and conditions spelt out in the RFP. We shall participate and submit the commercial Bid through online auction to be conducted by the ~~Bank's authorized service provider~~ **GeM Portal**, on the date advised to us.

i. While submitting this Bid, we certify that:

- The undersigned is authorized to sign on behalf of the Bidder and the necessary support document delegating this authority is enclosed to this letter.
- We declare that we fulfil the minimum eligibility criteria mentioned under this RFP.
- We declare that all the terms and conditions of this RFP and subsequent corrigendum / corrigenda are acknowledged & accepted and bid prepared and submitted accordingly.
- We declare that we are not in contravention of conflict-of-interest obligation mentioned in this RFP.
- Indicative prices submitted by us have been arrived at without agreement with any other Bidder of this RFP for the purpose of restricting competition.
- The indicative prices submitted by us have not been disclosed and will not be disclosed to any other Bidder responding to this RFP.

- We have not induced or attempted to induce any other Bidder to submit or not to submit a Bid for restricting competition.
  - We have quoted for all the Services / Items mentioned in this RFP in our indicative price Bid.
  - The rate quoted in the indicative price Bids are as per the RFP and subsequent pre-Bid clarifications / modifications / revisions furnished by the Bank, without any exception.
- ii. We undertake that, in competing for (and, if the award is made to us, in executing) the above contract, we will strictly observe the laws against fraud and corruption in force in India namely "Prevention of Corruption Act 1988".
- iii. We undertake that we will not offer, directly or through intermediaries, any bribe, gift, consideration, reward, favour, any material or immaterial benefit or other advantage, commission, fees, brokerage or inducement to any official of the Bank, connected directly or indirectly with the bidding process, or to any person, organisation or third party related to the contract in exchange for any advantage in the bidding, evaluation, contracting and implementation of the contract.
- iv. We undertake that we will not resort to canvassing with any official of the Bank, connected directly or indirectly with the bidding process to derive any undue advantage. We also understand that any violation in this regard, will result in disqualification of bidder from further bidding process.
- v. It is further certified that the contents of our Bid are factually correct. We also accept that in the event of any information / data / particulars proving to be incorrect, the Bank will have the right to disqualify us from the RFP without prejudice to any other rights available to the Bank.
- vi. We certify that while submitting our Bid document, we have not made any changes in the contents of the RFP document, read with its amendments / clarifications provided by the Bank.
- vii. We agree to abide by all the RFP terms and conditions, Contents of Service Level Agreement as per template available at Appendix-J of this RFP and the rates quoted therein for the orders awarded by the Bank up to the period prescribed in the RFP, which shall remain binding upon us.
- viii. On acceptance of our technical bid, we undertake to participate in Reverse auction by way of login in Reverse auction tool. In case of declaration as successful Bidder on completion of Reverse auction process, we undertake to complete the formalities as specified in this RFP.

- ix. The commercial bidding process will be through the reverse auction process to be conducted by the GeM. We understand that our authorized representative who would participate in the reverse auction process would be possessing a valid digital certificate for the purpose.
- x. Till execution of a formal contract, the RFP, along with the Bank's notification of award by way of issuance of purchase order and our acceptance thereof, would be binding contractual obligation on the Bank and us.
- xi. We understand that you are not bound to accept the lowest or any Bid you may receive and you may reject all or any Bid without assigning any reason or giving any explanation whatsoever.
- xii. We hereby certify that our name does not appear in any "Caution" list of RBI / IBA or any other regulatory body for outsourcing activity.
- xiii. **We hereby certify that on the date of submission of Bid for this RFP, <<we do not have / we have >> any past / present litigation which adversely affect our participation in this RFP or we are not under any debarment / blacklist period for breach of contract / fraud / corrupt practices by any Scheduled Commercial Bank / Public Sector Undertaking / State or Central Government or their agencies / departments. In case of past litigations (Running or closed) between Jan 2017 to till date, - We submit full details of the past litigations / present litigations as per Appendix-R).**
- xiv. We hereby understand that any concealment / misrepresentation / wrong information of any facts by us, may result in our disqualification / debarment at any Stage of this RFP / Contract period, at the sole discretion of the Bank.
- xv. We hereby certify that we (participating in RFP as OEM) / our OEM have a support centre and level 3 escalation (highest) located in India. The MAF format attached at **Appendix-O**. We propose to install the machines, for services under this RFP, as described below:

Sl.no	Endpoint	Model Name	Manufacturer / OEM
1	ATM 1		
2	ATM 2		

- xvi. We hereby certify that on the date of submission of Bid, we do not have any Service Level Agreement pending to be signed with the Bank for more than 6 months from the date of issue of purchase order.

xvii. If our Bid is accepted, we undertake to enter into and execute at our cost, when called upon by the Bank to do so, a contract in the prescribed form and we shall be solely responsible for the due performance of the contract.

xviii. Choose any one of the two (as case applicable): -

a) In case, we are the existing Vendor of the Bank under the Ministry of Finance (MOF) Agreement / Bank's TOM Agreement (prior to year 2013), we shall surrender the existing ATM site to the Bank, as per Bank requirement or allocation under present RFP. We shall support the Bank & the new vendor in assignment of the site rental agreement and other transition formalities to new vendor, without any additional cost to the Bank, within 30 days from the PO / instruction from the Bank for that site.

**OR**

b) In case, we are NOT the existing Vendor of the Bank under the Ministry of Finance (MOF) Agreement / Bank's TOM Agreement (prior to year 2013), we shall takeover the existing ATM site from the earlier Vendor, if desired by the Bank. We shall support the Bank & the old vendor in assignment of the site rental agreement and other transition formalities, without any additional cost to the Bank, within 30 days from the PO / instruction from the Bank for that site.

xix. We agree to complete establishment of the Service Centers at all the LHO / RBO centers for rollout of machines and deploy adequate manpower in the service centers subject to satisfaction of the Bank, within 60 days of issuance of purchase order, failing which the Bank may terminate the Agreement fully or partially and re-distribute the order to other selected vendors.

xx. We, further, hereby undertake and agree to abide by all the terms and conditions stipulated by the Bank in the RFP document.

xxi. We hereby certify that we have read the clauses contained in O.M. No. 6/18/2019-PPD, dated 23.07.2020 order (Public Procurement No. 1), order (Public Procurement No. 2) dated 23.07.2020 and order (Public Procurement No. 3) dated 24.07.2020 and as per subsequent guidelines issued by Govt of India procurement manual updated up to June 2022 regarding restrictions on procurement from a bidder of a country which shares a land border with India. We further certify that we and our OEM are not from such a country or if from a country, has been registered with competent authority. We certify that we and our OEM fulfil all the requirements in this regard and are eligible to participate in this RFP.



Dated this ..... day of ..... 2023

---

(Signature) (Name)

*(In the capacity of)*

Duly authorised to sign Bid for and on behalf of

---

**Seal of the company.**

## Appendix-B: **BIDDER'S ELIGIBILITY CRITERIA**

Bidders meeting the following criteria are eligible to submit their Bids along with supporting documents. If the Bid is not accompanied by all the required documents supporting eligibility criteria, the same would be rejected.

Bidders who do not fulfil any of the below criteria need not apply. Bidders who are capable of PAN India mass deployment and can start deployment quickly with full functionalities need only apply.

S. No.	Eligibility Criteria	Compliance (Yes/No)	Documents to be submitted/Documents to be uploaded
1.	The Bidder must be an Indian Partnership firm / LLP. / company / organization registered under Companies Act, 2013 or under any other act stipulated by the Law of land / Govt of India, and in existence for three years and continuing as on date of notification of RFP.		Copy of the Partnership deed / Bye Law / Certificate of Incorporation issued by Registrar of Companies along with Memorandum & Articles of Association and full address of the registered office.
2.	The bidder must have an average annual turnover of minimum Rs. 60 crores during last 03 Three financial year(s), The bidder who classifies into Micro and Small Enterprises (MSE), should have an annual turnover of Minimum Rs. 35 crores during last 03 Three financial year(s).		Copy of the audited balance sheets / along with profit and loss statement full set of documents in the audited annual report for last three FY: Option 1- FY 2020-21, 21-22 and 22-23. <b>OR</b> If audited balance sheet is not available for FY 2022-23 then, Option 2- FY 2019-20, 20-21 and 21-22. In addition, provisional financials for FY 2022-23 duly certified by statutory auditor of that firm / company to be submitted OR self-declaration by authorized signatory if provisional financials

S. No.	Eligibility Criteria	Compliance (Yes/No)	Documents to be submitted/Documents to be uploaded
			of FY 2022-23 is not available (FOR OPTION 2 ONLY).
3.	The net worth of the bidder firm should not be negative on the latest available audited balance sheet (31.03.2022 or 31.03.2023) and should not have eroded by more than 30 percent in the last three financial years.		Copy of the audited balance sheets / along with profit and loss statement full set of documents in the audited annual report for last Three FY: Option 1- FY 2020-21, 21-22 and 22-23. OR If audited balance sheet is not available for FY 2022-23 then, Option 2- FY 2019-20, 20-21 and 21-22. In addition, provisional financials for FY 2022-23 duly certified by statutory auditor of that firm / company to be submitted OR self-declaration by authorized signatory if provisional financials of FY 2022-23 is not available (FOR OPTION 2 ONLY).
4	Bidder's Declaration: Bidder to comply with requirements given in Appendix-S		Bidder should specifically confirm on their letter head in this regard as per <b>Appendix-S (strictly without any change) duly Notarized affidavit.</b>
5.	(a) Bidder should have experience of minimum 3 years in providing the services under TOM / Per Transaction cost model to Banks in India.  (b) Bidder should have installed and maintained minimum 1,000 ATMs under TOM / Per Transaction cost model to Banks in India as on 31/03/2023 successfully.		(a) & (b) Duly signed Letter from the client as per <b>Appendix-S1.</b>

S. No.	Eligibility Criteria	Compliance (Yes/No)	Documents to be submitted/Documents to be uploaded
	(c) Bidder will install ATMs from an OEM who has minimum installed base of 1,000 ATMs in Banks in India as on 31/03/2023 which are currently in working conditions <del>and countersigned by the Bank.</del>		(c) {Duly signed Letter from the <del>Client</del> OEM as per <b>Appendix-S2</b> }. Note: - Appendix- S2 shall be from the same OEM, mentioned in Appendix S1.
6-	<del>Satisfactory Two Client references which can be Public Sector Banks (PSUs) / Private Sector Banks in India, from whom Bidder / OEM has executed similar projects for at least 500 ATMs (which are currently in working conditions) and their maintenance services, as on 31.03.2023. (Applicable to bidder(s) which are not engaged with SBI under "Per Transaction Rate Model")</del>		<del>Bidder should specifically confirm on their letter head in this regard as per <b>Appendix-M</b></del>
7	Bidder should submit the Manufacturers' Authorization Form for each proposed model of ATM.		If bidder is OEM, <b>Appendix-O</b> to be submitted on letter head of OEM. If the OEM itself is not the bidder / applicant, Appendix-O to be submitted on letter head of OEM countersigned by the applicant / bidder.
8	Bidder to submit OEM's Certificate cum Letter of undertaking.		OEM's Certificate cum Letter of undertaking on their letter head in this regard as per <b>Appendix-S3</b> (Strictly without any change)

S. No.	Eligibility Criteria	Compliance (Yes/No)	Documents to be submitted/Documents to be uploaded
9	The local Manufacturing facility of the OEM / Bidder should have ISO 9001:2015 OR Equivalent international certification OR higher <b>and</b> BIS-IS 13252: Part 1: 2010.		Relevant certificates issued by competent authority (s) and should be valid.
10	Equipment to be provided should be working on Base-24 Switch.		One of the following is required to be uploaded: (a) Self-declaration of OEM required – If the proposed model of ATM is currently working at SBI, OR (b) Self-declaration of OEM required – If the proposed model of ATM is new and not installed in any other scheduled commercial bank in India but earlier versions / previous model(s) of that OEM is/are currently working at SBI or in any other scheduled commercial bank in India. OR (c) Certificate from any scheduled commercial bank certifying that the proposed model offered under this RFP is Tech live on its Base-24 switch-Classic and working satisfactory.
11.	Bidder / should have Online Helpdesk / Management Centre Support Set up – 24 x 7 in India and providing technical support services on phone at least 5,000 ATMs and Support Centres at various locations.		Bidder should specifically certify <b>Appendix-S4</b> in this regard.

S. No.	Eligibility Criteria	Compliance (Yes/No)	Documents to be submitted/Documents to be uploaded
12	The bidder should classify as class I or class II local supplier as per the guidelines on Public Procurement (preference to make in India) order 2017 and subsequent amendments up to date of issuance of this RFP.		As per format in Appendix-G and G1: Certificate of Local Content  Appendix-G and G1 be submitted by all bidders irrespective of the estimated value of procurement.
13	The Bidder to give the confirmation letter for providing support for MVS, EPS, OMS (of SBI) and other software(s) implementation in their ATM supplied.		Duly signed Letter on the letter head of ATM Provider / Bidder countersigned by OEM as per <b>Appendix-S5 &amp; S5 (a)</b> , without any change.  If bidder is not an OEM, it is required to be signed by Bidder & countersigned OEM. If bidder is an OEM, it is required to be signed by Bidder as Bidder as well as OEM.

Documentary evidence must be furnished against each of the above criteria along with an index. All documents must be signed by the authorized signatory of the Bidder. Relevant portions, in the documents submitted in pursuance of eligibility criteria, should be highlighted.

**Eligibility criteria mentioned Turnover and Experience in table above are relaxed for Start-ups / MSE subject to producing necessary eligibility documents and also their meeting of quality and technical specifications. Bidder to note the followings:**

- i. Start-up” company should enclose the valid Certificate of Recognition issued by Department for Promotion of Industry and Internal Trade (DPIIT), (erstwhile Department of Industrial Policy and Promotion), Ministry of Commerce & Industry, Govt. of India with the technical bid.
- ii. Bidder who solely on its own, fulfils each eligibility criteria condition as per the RFP terms and conditions and who are having Start-up company status, can claim exemption for eligibility criteria mentioned in table above.
- iii. If all these conditions are not fulfilled or supporting documents are not submitted

with the technical Bid, then all those Bids will be summarily rejected, and no queries will be entertained.

**Name & Signature of authorized signatory**

**Seal of Company**

<b>Appendix-B-1</b>					
<b>ANNUAL DATA</b>					
[₹ in crores]	As at close of business as on				
	<b>31.03.2019</b>	<b>31.03.2020</b>	<b>31.03.2021</b>	<b>31.03.2022</b>	<b>31.03.2023</b>
<b>Annual Turnover</b>					
<b>Profit Before Tax</b>					
<b>Capital &amp; Reserves</b>					
<b>Net worth</b>					

**Name & Signature of authorised signatory**

**Seal of Company**

**Appendix-C**  
**(Consisting of C1 TO C4)**

**TECHNICAL & FUNCTIONAL SPECIFICATIONS**

To qualify in the Technical Evaluation, a Bidder must comply with all the requirements as listed in the table below. Bidder(s) must submit their response in **YES** or **NO** only with indication **F / C / N**, as detailed below. Any NO or N with qualified statement shall be treated as non-compliance.

The participating bidder(s) is/are required to submit conformity to technical proposal in the GeM portal as per Appendix-C of this RFP.

	Technical Bid Rules <b>Appendix-C1 TO C4</b> <b>Appendix-C1 → ATM Hardware Specifications</b> <b>Appendix-C2 → ATM Software Specifications</b> <b>Appendix-C3 → ATM Support Services</b> <b>Appendix-C4 → Specifications of UPS</b>
--	--

<b>Technical Bid Rules for Appendix-C1 to C4</b>	
F	Available Out of Box- Fully as part of Solution
C	Will be provided as Customization between 1- 180 days from the date of delivery of machines at Bank's IT Lab for testing.
N	It is not possible to provide this feature.
Not e 1	Applicant needs to give one of the above values in column F/C/N in the following table as regards to compliance.
Not e 2	Applicant to give supporting technical brochures / documents / presentation etc. in support of the undernoted each of the Technical / Functional / Requirement of Solution.
Not e 3	F / C / N: Any wrong reporting in the column 'F / C / N ', which subsequently transpired during the pilot testing or any stage shall render the Applicant liable to be blacklisted for the future participation in the RFPs/Tenders of the Bank and forfeit the EMD
Not e 4	Map your module: Applicant to clearly spell out against each of the Technical/Functional Specifications/Requirement of Solution, the name of the applicant's module where 'F/C' have been given in the column Validation Criteria.



Not e 5	Mention Page No. of RFP Submitted: Applicant to invariably mention the page number of RFP against each of the Technical / Functional Specification with supporting technical brochures / documents / presentation etc, failing which, it will be at the discretion of the Bank to treat the same as Not Feasible - 'N', which may render the bidder ineligible in the future process of RFP.
Not e 6	Mandatory: Means Requirements/functionality should either be available Fully as part of the solution [F] or through Customization [C].
	Any comment or caveat or exception or assumption against each of the point or separately will not be considered and Bank reserve the right to treat the same as 'N', which may render the bidder ineligible in the further process of RFP.
Not e 7	Applicants need to give one of the values(C), if the feature is not readily available and needs to be customized based on the readiness duration as mentioned above.

## Acronyms Used

Acronym	Description
AMC	Annual Maintenance Contract
CD	Cash Dispenser
MGD / MS	Managed Services
ATS	Annual Technical Services
OATS	Onsite Annual Technical Services
HW	Hardware
SW	Software
EP / SP	Endpoint Provider / Service Provider
SP	Solution Provider
MVS	Multi-Vendor Software
EPS	Endpoint Protection Software
OMS	Online Monitoring System
CEN	European Committee for Normalisation/Standardization
XFS	eXtension for Financial Services
OS	Operating System
LOA	Letter of Approval
TQM	Terminal Quality Management (MasterCard)
IFM	Interface Module
PCD	Proximity Coupling Devices
SNMP	Simple Network Management Protocol

PCI	Payment Card Industry
PTS	Pin Transaction Security
PED	Pin Entry Device
EPP	Encrypting Pin Pad
ATM	Automated Teller Machine
TTS	Text-to-Speech
DES	Data Encryption Standard
RSA	Ron Rivest, Adi Shamir and Leonard Adleman
AES	Advanced Encryption Standard
DSS	Data Security Standard
NDC	NCR Direct Connect
DDC/912	Diebold Direct Connect
IFX	Interactive Financial eXchange
ISO	International Organization for Standardization
XML	eXtensible Markup Language
EMVCo	Europay, MasterCard, and Visa Corporation
UIDAI	Unique Identification Authority of India
OEM	Original Equipment Manufacturer
CRUD	Create, Read, Update and Delete
FCR	Field Call Report
HTC	Handover Takeover Certificate
PM	Preventive Maintenance
FLM	First Line Maintenance
EPIC	Endpoint Install Certificate
ESR	Electronic Settlement & Reporting
OTC	One Time Combination
SSH	Secure Shell Security
SSL	Secure Socket Layer
SLA	Service Level Agreement
B2B	Business to Business
API	Application Programming Interface
QR	Quick Response
NFC	Near Field Communication
AKDS	Automated Key Distribution System
RKL	Remote Key Loading
MAC	Message Authentication Code

EJ	Electronic Journal
GUI	Graphical User Interface
OTP	One Time Password
TAT	Turn Around Time
FHDE	Full Hard Disk Encryption
SIEM	Security Information and Event Management
DLL	Dynamic Link Libraries
CASH-REPL	Cash Replenishment - Requirements
CASH-MGMT	Cash Management - Requirements
HELP-DESK	Help Desk - Requirements
DATA-SEC	Data Security - Requirements
NTWK-MGMT	Network Management - Requirements
DIST-MGMT	Software Distribution (Upload/Download) Management - Requirements
OTC-MGMT	One Time Combination (Chest/Safe Access Control) Management - Requirements
FLM-REQS	First Line Maintenance - Requirements
CR	Cash Recycler
ADWMs	Automated Deposit-cum-Withdrawal Machines

<b>Module/Item</b>	<b>Description</b>
ATM-APPL-SWDIST	ATM Application - Software Distribution Requirements
ATM-APPL	ATM Application - General Requirements
ATM-APPL-EPSWL	ATM Application - Endpoint Protection Whitelisting Requirements
ATM-APPL-LANG	ATM Application - Language Support Requirements
ATM-APPL-VSS	ATM Application - Video Surveillance Software Requirements
ATM-APPL-TXNTYP	ATM Application - Transaction Type Requirements
ATM-APPLTESTING	ATM Application - Application / Transaction Testing requirements
FLM-REQS	First Line Maintenance - Requirements
CASH-REPL	Cash Replenishment - Requirements

CASH-MGMT	Cash Management - Requirements
HELP-DESK	Help Desk - Requirements
DATA-SEC	Data Security - Requirements
NTWK-MGMT	Network Management - Requirements
DIST-MGMT	Software Distribution (Upload/Download) Management - Requirements
OTC-MGMT	One Time Combination (Chest/Safe Access Control) Management - Requirements
ATM-SWDIST	ATM Application- Software Distribution.

**Appendix-C1 → ATM Hardware**

Module	Item	Feature Id	Features	Mandatory	Validation Criteria (F/C/N) (Put any one)	Response (YES / NO)	Map your module	Page no. of RFP Submitted
ATM	Processor	1.1.0	<p>9th Generation Intel® Core™ i5 Processor or higher with minimum 3.3 GHz or above and 3 MB cache or above is permitted. The minimum specified GHz in Turbo mode is permitted. Vendor to provide the supported OS/patching related software/hardware upgrades without any cost to the Bank during the contract period.</p> <p>Higher Processor Means</p> <p>Higher or above is clarified from below examples:</p> <p>10th generation i5 processor is considered higher.</p> <p>9th Generation i7 processor is considered higher.</p> <p>6th or lower Generation i7 processor is not considered higher.</p>	Y	F/N			
ATM	Processor	1.2.0	<p>8 GB DDR3 RAM or higher with scope to increase capacity in existing motherboard whenever required. There should be extra RAM slots in the motherboard to increase capacity whenever required.</p>	Y	F/N			

ATM	Processor	1.3.0	500 GB SSD (primary) or higher and 1 TB SATA / e-SATA HDD (secondary). In case, Bank requires primary SSD of 1 TB, the same should be installed without any additional cost to the Bank.	Y	F/N/C			
ATM	Processor	1.4.0	USB ports in front for front access ATMs	Y	F/N			
ATM	Processor	1.5.0	Microsoft Windows 11 Else Microsoft Windows 10 Enterprise IOT 2019 or higher with latest service packs. In case supplied OS is declared end of support by Microsoft, the bidder has to replace the same with a supported OS including the supported hardware changes or provide compensating controls without any cost to Bank.	Y	F/N			
ATM	Processor	1.6.0	OS Hardening (with local firewall) guidelines issued by the OS supplier and the Bank's IS Policy should be strictly followed.	Y	F/N			
ATM	Device SW	2.1.0	Software with CEN XFS 3.10 or above compliant and cross vendor support, documentation, and terminal diagnostics / utilities and capable of running Multi-Vendor Software without any hardware changes. Testing, installation and operationalization of same without any additional cost to the Bank.	Y	F/N			
ATM	Device SW	2.2.0	Software with drivers (for non-XFS devices), API documentation, and terminal diagnostics/ utilities.	Y	F/N			
ATM	Device SW	2.3.0	Capable of supporting any ATM Protection/Whitelisting solution procured by Bank with a view to prevent malware including viruses, worms and Trojans should enter and affect the system.	Y	F/N			

ATM	Device SW	2.4.0	OEM/Service provider is required to provide latest OS and Cen XFS application version to support Regulatory requirement or Bank's need to support MVS and EPS applications during the contract period.	Y	F/N			
ATM	Currency Chest	3.1.0	S&G / KABA / Securam (or an equivalent make, of high international repute), Centrally / Remote controlled dual electronic combination lock of 6 + 6 digits with capability for one-time combination (OTC) and audit trail without any hardware change. Lock should be programable from a central system to generate OTC as per the schedule by Bank / CIT. Any key / hardware required to operationalize and use OTC must be arranged by the Bidder at their own cost.	Y	F/N			
ATM	Currency Chest	3.3.0	Alarm sensors for temperature status, seismic or vibration status and chest open status while sending signal / messages to Switch / Management Centre. CD should have alarm sensors capable of monitoring the above status and having capability to send signals / messages / alerts in case of Chest Door Open status / thermal status / vibration status	Y	F/N			
ATM	Currency Chest	3.4.0	Terminal should be able to change automatically to Supervisory / Maintenance/Out-Of- Service mode, in following cases when: (a) when cabinet/Hood Door is opened (b) Chest / Safe door is opened. The Terminal should not dispense / initiate dispensation process when in Supervisory / Maintenance / Out-Of-Service mode except when required for Testing / fault resolution by Engineer.	Y	F/N			

ATM	Currency Chest	3.5.0	Terminal should be able to change automatically to In- Service / Transaction mode, after Chest door and Hood door is locked.	Y	F/N			
ATM	Currency Chest	3.6.0	UL 291 Level 1 / CEN 1 Certified Secure Chest or higher. It is preferred that CEN 1 Certified Secure Chest be provided, ab initio. In case, CEN 1 is not readily available, machines can be provided with UL 291 Level 1 chest.	Y	F/N			
ATM	Dispenser	4.1.0	Dispense minimum 40 currency notes per transaction.	Y	F/N			
ATM	Dispenser	4.2.0	Dispense used notes	Y	F/N			
ATM	Dispenser	4.3.0	Capable to retract notes but this functionality should be in disabled mode	Y	F/N			
ATM	Dispenser	4.4.0	Indication (visible / audible and software) of proper insertion of all cassettes.	Y	F/N			
ATM	Dispenser	4.5.0	2 x Double Pick Module, and 4 currency cassettes and reject bin with lock & key (2 sets)	Y	F/N			
ATM	Dispenser	4.6.0	Reject BIN or Divert cassette bin with lock and key with capacity to hold at least 200 notes. The balance in the reject bin should be mentioned after each transaction in the EJ, along with the denomination wise pieces. Machine should be capable to mention the currencies sent to the reject bin and update the counter and admin balances accordingly.	Y	F/N			
ATM	Dispenser	4.7.0	Each Cassette should hold minimum of 2500 currency notes.	Y	F/N			
ATM	Dispenser	4.8.0	Capable of Multi currency dispensing	Y	F/N			



ATM	Dispenser	4.9.0	Capable of dispensing all denominations Rs.50, Rs.100, Rs. 200/- , Rs. 500/- as well as any new denominations, if any, issued subsequently during full contract period, without any extra cost to the Bank. All cassettes should be adjustable to hold and dispense the currency notes if dimensions of currency notes are changed without any additional component requirement.	Y	F/N			
ATM	Dispenser	4.10.0	Dispense at least 5 notes per second	Y	F/N			
ATM	Dispenser	4.11.0	Machines should not dispense soiled, mutilated notes	Y	F/N			
ATM	Dispenser	4.12.0	Encrypted communication and trust relation should be established between PC core and dispenser.	Y	F/N			
ATM	Dispenser	4.13.0	Should not have any hardware module sensors which could be accessible by any end consumer either during idle state or during transaction processing	Y	F/N			
ATM	Dispenser	4.14.0	Multi-media dispenser (ticket/coupon/stamp/ receipt) with bunch presenter	Y	F/N			
ATM	Dispenser	4.16.0	Friction / Vacuum pick technology	Y	F/N			
ATM	Dispenser	4.17.0	Vendor to provide all the model of ATMs as specified in the submitted MAFs of OEMs. Any vandalized machine will also be replaced with the same make & model without any cost to the bank.	Y	F/N			
ATM	Dispenser	4.18.0	Dispensation status should be logged for every withdrawal transaction. There cannot be any withdrawal transaction with status as 'Dispensation status unknown'	Y	F/N/C			

ATM	Dispenser	4.19.0	Any new foreign material inside the dispenser or at the presenter area should be sensed. If found, machine should be put out of service till be error is cleared	Y	F/N/C			
ATM	Dip Card Reader (Hybrid)	5.1.0	Smart Card, Chip Card EMVCo Version 4.0 or later, as certified, with supporting EMVCo L1 LOA. On expiry of certificate, it should be replaced with valid certificate at no additional cost to the Bank.	Y	F/N			
ATM	Dip Card Reader (Hybrid)	5.2.0	EMVCo Level 2 approved terminal application/kernel. On expiry of certificate, it should be replaced with valid certificate at no additional cost to the Bank.	Y	F/N			
ATM	Dip Card Reader (Hybrid)	5.3.0	Should provide necessary certificates/approvals from VISA, Master Card, Amex, Union Pay, Rupay, Discover including TQM(IFM) certificates. On expiry of certificate, it should be replaced with valid certificate at no additional cost to the Bank.	Y	F/N			
ATM	Dip Card Reader (Hybrid)	5.4.0	Card reader should be compatible to work with any valid EMVCo certified EMV Kernels.	Y	F/N			
ATM	Dip Card Reader (Hybrid)	5.5.0	ATM should be ready for using the new EMV Chip Cards i.e., EMV Chip Card Reader enabled.	Y	F/N			

ATM	Dip Card Reader (Hybrid)	5.6.0	<p>Dip Smart Card Reader with anti-skimming device and anti-shimming device installed and integrated with the card reader of the ATM. Details of the anti-skimming technology / device to be enclosed. The bank is looking for a comprehensive skimming protection solution which achieves the following: -</p> <p>i) Senses unauthorized attachment of any device on the card reader module,</p> <p>ii) Sends the signal to switch and further to the Remote ATM Management Centre of the vendor and Online Monitoring Solution of the Bank,</p> <p>iii) Capable of enabling the switch to put the machine Out-Of-Service as well as block the card reader from accepting any more card insertions. XFS needs to send out error status so that the SNMP/MVS can pick it up and notify the monitoring system.</p> <p>iv) should be equipped with solution/device for protecting from Deep insert skimming and shimming.</p>	Y	F/N			
ATM	Dip Card Reader (Hybrid)	5.7.0	<p>Communication link between the card reader and system should be encrypted by latest encryption standards. (This is between the Card Reader and the ATM) Communication link between the card reader and XFS application should be encrypted by latest encryption standards. Communication link between the XFS and ATM application should be encrypted by latest encryption standards.</p>	Y	F/N			

ATM	Dip Card Reader (Hybrid)	5.8.0	Card reader should be capable of disabling reading the magstrip as and when required by the Bank. If physical visit is required for disablement, vendor to arrange the same at no additional cost to the Bank	Y	F/N			
ATM	Dip Card Reader (Hybrid)	5.9.0	Capable to read magnetic tracks 1 & 2	Y	F/N			
ATM	Customer Interface / Fascia	6.1.0	15" LCD/ LED or higher touch screen with standard bright and full screen display. In case, the touch screen of the machine without FDK, is frequently down due to non-working of touch screen, then Vendor should replace the machine with the model which has FDK with Touch Screen or install FDK in the existing machine, without any additional cost to the Bank.	Y	F/N			
ATM	Customer Interface / Fascia	6.3.0	Vandal screen with Privacy filter. Resistance to Indian weather, vandal proof and pertinent to and Indian usability condition	Y	F/N			
ATM	Customer Interface / EPP	6.4.0	Rugged spill proof Triple DES enabled keyboard with polycarbonate tactile/stainless Steel EPP pin pad. EPP Keypads to be PCI-PTS compliant with sealed metal keypad. PIN Pads shall be covered to prevent PIN disclosure via shoulder surfing. EPP should be designed so as to prevent overlaying of fake pin pad. Forcible removal of EPP should bring the machine down resulting in loss of data stored in the EPP, so as to prevent compromise even with high end decryption. Please provide details of the technology / solution. Should accompany with PCI certificate. On expiry of certificate, it should be replaced with valid certificate at no additional cost to the	Y	F/N/C			

			<p>Bank. EPP Pin Pad Should be with Braille Embossings.</p> <p>In case, Braille Keypad (as shown pictures in this RFP) is not readily available, bidders can supply machine without Braille embossings in each key. However, in case any guideline is issued by any entity (RBI/IBA/NPCI/ Gol etc.) to ensure each key with Braille Embossing, then the same should be provided by the bidder at no extra cost to the Bank. In case, any penalty is imposed on the Bank for not having the braille embossing in each key, the same should be made good by the bidder.</p>					
ATM	Customer Interface / Fascia	6.4.1	<p>There shall be SBI's YONO branding colour scheme on the fascia of the machine. The fascia should be factory painted in the SBI INK BLUE COLOUR (L481-105899 RGB 40-0-113 Hex #280071) scheme and YONO PRINTED vinyl wraps SHOULD BE STUCK ONTO THE MACHINES. During the life of the machine, any repair/replacement of fascia should have the same original branding.</p> <p>The acrylic parts should be of the single SBI Blue colour specified in the RFP. The visible screen, keypad, front console can be as per OEM's default colour. The final colour appearance will be discussed with the successful bidders before implementation &amp; rollout. The successful bidders should provide a 3D model representation for visualization and clarity. The Bank's decision will be binding on the successful bidder. The final appearance will be decided by the Bank after taking into consideration the 3D model. There should not be fading or torn off vinyl wraps and their replacements to be done by the bidder on their own</p>	Y	F/N			

			without waiting for Bank's intimation. If such replacement is advised by the Bank, it should be completed by the bidder within 5 days of intimation. Penalty @ ₹ 100 per day from the 6th Day onwards per non-complied ATM will be levied.					
ATM	Customer Interface / Fascia	6.5.0	Touch Screen (with support for visually handicapped through Function Keys / EPP wherever required). Braille stickers and text speech device on all devices as per requirement to support the visually challenged	Y	F/N			
ATM	Customer Interface / Fascia	6.6.0	All devices to have features as per requirements to support the visually challenged. All ATMs to meet the requirement of 'Talking ATMs' as per IBA guidelines (EP needs to ensure that braille supported keys (Pin Pad, Function Keys, Locations of key devices, Audio jack) are present on the ATM. SP can support with voice guidance/headphone audio from the MVS software standpoint.)	Y	F/N			
ATM	Customer Interface / Fascia	6.7.0	Trilingual Screen Support (English, Hindi, Regional Language), in static graphics (PCX, JPEG, etc) and video files (incl. MP4)	Y	F/N			
ATM	Customer Interface / Fascia	6.8.0	Terminal should be capable to display graphic screen and video files in commonly available picture formats (MPEG, MP4, PCX, JPEG, BMP etc.).	Y	F/N			
ATM	Customer Interface / Fascia	6.9.0	Voice guidance support with internal speakers and headphone jack 3.5 mm (hardware as well as software both to be provided with ATM). Capable of voice guidance to the customer and digitalized wave files in the Indian accent for the same in Hindi & English	Y	F/N			

			languages to be provided by the vendor. There should be support for text to speech for full-fledged voice guidance solution implementation as per IBA guidelines without any extra cost to the Bank.					
ATM	Customer Interface / Fascia	6.10.	Provide Text-to-Speech (TTS) support in English, Hindi and regional languages.	Y	F/N			
ATM	Customer Interface / Fascia	6.11.0	Terminal should be capable to integrate with custom / 3rd party Text-to-Speech (TTS) software.	Y	F/N			
ATM	Customer Interface / Fascia	6.12.0	Terminal should report status (XFS) whether headphone is present / not present in headphone jack, to the monitoring system	Y	F/N			
ATM	Customer Interface / Fascia	6.13.0	Voice guidance support with internal speakers and headphone jack	Y	F/N			
ATM	Customer Interface / Fascia	6.14.0	MPEG - 4 full motion video support, and support for common video codecs.	Y	F/N			
ATM	Integrated ATM Surveillance Solution (DVSS)	7.1.0	Solution must be motion-sensitive and capable of capturing image of the person while doing transaction in the ATM. Camera should be suitably positioned to take image of the person even under extreme / difficult lighting conditions. It shall be the responsibility of the bidder to ensure that the images so captured are able to identify the persons entering the ATM room. The cameras should be pilfer-proof.	Y	F/N			

ATM	Integrated ATM Surveillance Solution (DVSS)	7.2.0	Solution should be able to store the images in a digital format for minimum 6 months at an average of 400 transactions per day. The back-up should be taken at quarterly intervals or earlier as per requirement by the Bank and supervised by the Vendor. The images will be stored on one of the 2 Hard Disks in the machine. Vendor to increase storage capacity for machines having more than average 400 hits per day accordingly.	Y	F/N			
ATM	Integrated ATM Surveillance Solution (DVSS)	7.3.0	The resolution of the camera should be atleast High Definition (1080p) to capture the quality image of the object for clear identification. In case of image clarity could not identify the object clearly and Bank is unable to ascertain the object, such complaint / loss shall be attributable to the Vendor.	Y	F/N			
ATM	Integrated ATM Surveillance Solution (DVSS)	7.4.0	Solution must provide an interface to browse, search and archive the stored images on hard disk or external media.	Y	F/N			
ATM	Integrated ATM Surveillance Solution (DVSS)	7.5.0	Solution must be able to capture & stamp the transaction information (card number masked to comply with PCI-DSS) on the images.	Y	F/N			
ATM	Integrated ATM Surveillance Solution (DVSS)	7.6.0	The solution must have a search facility to locate an image/event by date & time, card no., transaction reference no. and ATM ID.	Y	F/N			



ATM	Integrated ATM Surveillance Solution (DVSS)	7.7.0	The solution must be capable of monitoring from a central location. The Solution should be able to pull the required images from the central location and share the same over e-mail/sftp/other communication medium with bank officials, as and when required.	Y	F/N			
ATM	Integrated ATM Surveillance Solution (DVSS)	7.8.0	The image surveillance solution must not degrade the performance of ATM, e.g., speed of normal transaction. The solution should be able to pull the required images from the Central Location and share the same over e-mail with Bank officials, as and when required.	Y	F/N			
ATM	Integrated ATM Surveillance Solution (DVSS)	7.9.0	The image surveillance hardware should be integrated within the ATM.	Y	F/N			
ATM	Integrated ATM Surveillance Solution (Camera)	7.10.0	Cash Slot camera: A Camera should be present within the machine at the cash slot to capture the movement of cash from the presenter belt and final withdrawal by the customer. The camera should be capable of taking images and videos of the cash movement. The images and videos should be time stamped with Terminal ID, Masked Account & Card no. etc. The images and videos should be saved in the Hard disk and should be capable of being pulled centrally. The OEM to provide the necessary drivers for the camera and assist in the integration with the Bank's MVS Software. The bank will require these images and videos for disputed transactions. Failure to provide the image and video for the transactions	Y	F/N/C			

			required by the Bank, the Vendor to pay penalty of Rs.1,000/- or the disputed amount, whichever is higher. Bidder should provide required support to ATM application vendor (Solution provider) and obtain sign off from Bank before production movement.					
ATM	ATM	7.11.0	ATM must be capable of performing under extreme conditions. Temperature: 0 degree Celsius to +50 degree Celsius (Without Air Conditioner) Relative Humidity: 5 to 95 % (Without Air Conditioner)	Y	F/N			
ATM	ATM	7.12.0	Solution should be able to integrate with any Multi- Vendor ATM Software available with Bank to facilitate the pulling of images centrally.	Y	F/N			
ATM	ATM	7.13.0	The Solution should be capable of notifying the Switch in case the DVSS camera is covered / blocked by any means so that the Cash Dispenser does not dispense cash.	Y	F/N/C			
ATM	DES Chip / Security	8.1.0	Capable of Remote Key Management - Triple DES/RSA, Certificate or Signature-based.	Y	F/N			
ATM	DES Chip / Security	8.2.0	Triple DES chip with encryption/ verification/ validation software. Should support AES without any additional hardware	Y	F/N			
ATM	DES Chip / Security	8.3.0	ATM should be with in-built security features to trigger alarm in case of fire, hammering / tilting of the machine	Y	F/N			
ATM	Connectivity	9.1.0	Should have Network Interface Card (NIC) 10/100/1000 Mbps	Y	F/N			

ATM	Connectivity	9.2.0	<p>Equipment to be, provided should be certified working on Base 24 switch with full EMV compliance, should be capable of connecting to the existing ATM Switch (Base24) or any other Switch introduced by the Bank in future, using existing device handlers (NDC version 4.0/ D912) at no additional cost to the Bank. One of the following is required to be uploaded:</p> <p>(a) Self-declaration of OEM required along with completion of EMV certification already obtained under Bank's MVS application- If the proposed model of endpoint is currently working at SBI with EMV compliance having valid L1 &amp; L2 certificate, or</p> <p>(b) Certificate from any scheduled commercial bank certifying that the proposed model offered under this RFP is Tech live on its Base24 switch with EMV compliance having valid L1 &amp; L2 certificate and working satisfactory. or</p> <p>(c) If the proposed model is not working at SBI or any other Banks in India, Bidder to provide valid L1 &amp; L2 EMV certificates, with in a period of 15 days of LOI, to the Bank. Bank may facilitate for the certification with Base24 switch, for which a fee of Rs 20 lacs will be charged per model by the Bank from the Bidder. In case of both (b) &amp; (c), since EMV certification is required to be done for the Bank's MVS as L3 application for all the card networks interfaced by Bank, certification cost of Rs. 15 lacs shall be charged per model by the Bank from the Bidder.</p>	Y	F/N			
-----	--------------	-------	---	---	-----	--	--	--

ATM	Connectivity	9.3.0	ATM must support TCP/IP and DNS	Y	F/N			
ATM	Connectivity	9.4.0	ATM must Support TLS 1.2 or above and shall provide required software, if any.	Y	F/N			
ATM	Connectivity	9.5.0	Should support IPv4 addressing and be IPv6 ready. Ability to perform IPv4-IPv6 integration, if required at no additional cost to bank.	Y	F/N			
ATM	Receipt	10.1.0	Minimum 40 column Graphic Thermal Receipt printer with dual mode printing	Y	F/N			
ATM	Receipt Printer	10.2.0	Machine should print customer slip in HINDI and English and regional languages. (EP needs to ensure that the printer driver/firmware supports multiple font printing.)	Y	F/N			
ATM	Receipt Printer	10.2.1	Printer driver/firmware needs to support Hindi, English and regional Indian type fonts/specification.	Y	F/N			
ATM	Electronic Journal (EJ)	10.6.0	The Cash Dispenser should be capable of supporting a third-party software agent such as SDMS (Scientific Data Management System)/ Infobase / Radia, etc. The vendor also agrees to install any software selected by the Bank at no cost to the Bank.	Y	F/N			
ATM	Software	11.1.0	Capable of supporting any Multi-Vendor Software Application procured/available with the Bank. Bidder is required to support other MVS also in case Bank changes its current MVS during the contract period. If Bank procures new MVS Software to replace the existing MVS Software, Bank shall pay the Testing / Professional Charges of Rs. 12 lakh (for ATMs) to the bidder after successful testing and implementation on each	Y	F/N			

			machine supplied by the Bidder. No visit charges shall be paid to the bidder for implementing the new MVS Solution.					
ATM	Software Agent	11.2.0	Remote diagnostic agent to diagnose problems with the machine including but not limited to predicting part failures. This service including proactive rectification of problems reported by remote diagnostic agent will have to be provided by the applicant/ bidder/ OEM mandatorily at no extra cost to the Bank.	Y	F/N			
ATM	Media Status	12.1.0	Low and media empty warning for all items viz. currency notes, consumer printer rolls etc.	Y	F/N			
ATM	Power	13.1.0	In-built SMPS to work on 230V 50 Hz power supply.	Y	F/N			
ATM	Power	13.2.0	Support input voltage of 230V AC /50 Hz with +/- 5% variation.	Y	F/N			
ATM	Power	13.3.0	ATM should have Low Carbon Footprint i.e., Low Power consumption in operation as well as in idle condition.	Y	F/N			
ATM	Power	13.4.0	ATM should have Integrated Power Management Solution. The ATM software must be capable of interfacing with the Bank's UPS systems and query the battery status, in-line power and temperature, taking the machine out of service if the battery capacity is too low, perform scheduled power offs and automatically start up at the configured date and time. The solution must shut down gracefully to allow completion of the ongoing transaction in the event of complete battery discharge. The above power management functionality must be controllable remotely. In this situation, ATM should have the capability of	Y	F/N			

			generating message of low battery status and should send the same to the switch.					
ATM	Maintenance	14.1.0	<del>Bidder should provide hardware, software and MIS (Keyboard, Mouse etc.) for day-to-day operations whenever required for the maintenance of machines.</del>	Y	F/N	-		
ATM	Customer Interface / Fascia	15.1.0	Bidder to integrate – where required -- the alarm sensors of the ATM to the branch siren/hooter without any additional cost to Bank.	Y	F/N			
ATM	Customer Interface / Fascia	15.2.0	ATM should have Rear View Mirrors covering major area of the site which allow users to see what is happening behind to avoid shoulder surfing	Y	F/N			
ATM	Customer Interface / Fascia	15.3.0	ATM should have PIN pad shield covering all three sides to avoid shoulder surfing and capture by the external cameras.	Y	F/N			
ATM	Customer Interface / Fascia	15.4.0	Every ATM should have a unique hood lock and key.	Y	F/N			
ATM	Contactless Card Reader	16.1.0	The NFC contactless module with support contactless card Integration (hardware and Software) supporting upto ISO 14443 Type A/Type B, Mi Fare ISO 21481 and ISO/IEC 18092 or higher. In case any new guidelines or the	Y	F/N			

			regulator mandates newer specifications, the service provider should provide required support for hardware /software without any additional cost to the Bank during the contact period.					
ATM	Contactless Card Reader	16.2.0	Smart Card/ Chip Card EMVCo Contactless Version 2.1 or later, as certified with supporting EMVCo L1 LOA. On expiry of certificate, it should be replaced with valid certificate at no additional cost to the Bank.	Y	F/N			
ATM	Contactless Card Reader	16.3.0	EMVCo Level 2 approved terminal application/kernel. On expiry of certificate, it should be replaced with valid certificate at no additional cost to the Bank.	Y	F/N			
ATM	Contactless Card Reader	16.4.0	Should provide necessary certificates/approvals from VISA, Master Card, Amex, Union Pay, Rupay, Discover including TQM(PCD) certificates. On expiry of certificate, it should be replaced with valid certificate at no additional cost to the Bank.	Y	F/N			
ATM	Biometric	17.1.0	Should be UIDAI certified device for biometric capture and authentication. On expiry of certificate, it should be replaced with valid certificate at no additional cost to the Bank.	Y	F/N			
ATM	Biometric	17.2.0	Support Biometric Based Authentication API v 2.0 specifications (should be UIDAI certified biometric device for biometric capture and authentication). On expiry of certificate, it should be replaced with valid certificate at no additional cost to the bank.	Y	F/N			

ATM	Bar Code Scanner	18.1.0	ATM should have capability to integrate 1D/2D barcode and QR code scanner for future requirements of scanning codes from mobile phones by simply attaching a reader, compliant with Code128, Code39, QR Code standards.	Y	F/N			
ATM	Bar Code Scanner	18.2.0	Should be capable of reading barcodes of all popular symbologies, including Code 128, with up to 36 Characters	Y	F/N			
ATM	Testing	19.1.0	The necessary technology/ application/ hardware for supporting card based, cardless and biometric transactions should be available ab-initio.	Y	F/N			
ATM	Testing	19.2.0	Should provide necessary resources including paper rolls (for receipt printer, etc.) for lab testing purpose at no additional cost.	Y	F/N			
ATM	Software Testing	19.4.0	OEM Vendor/Service Provider to deploy resources whenever required, for testing the functionality at the ATM LAB at no extra cost.	Y	F/N			
ATM	Software Testing	19.5.0	L-3 Certification with MasterCard, Visa, Rupay or any other provider to be done by the service provider	Y	F/N			
SW	Software Testing	19.6.0	Vendor should arrange to support all security review and testing provided by Bank as and when required.	Y	F/N			
ATM	Hardware	21.1.0	Co-ordinated LED Lights Indicators at Card Reader, Cash slot dispenser, Receipt printer, The LED Lights at these places will blink accordingly during the course of transaction attracting the attention of the customer to that part of the machine. These coordinated LED lights but can be explored at keypad area and FDK (if present) by the OEMs	Y	F/N			



			in future. Bank would like to have backlit keypad and FDK for its future procurements. When cash dispensed Beep sound at cash slot to attract attention of customer.					
ATM	Interface for Banking software and & Switch Connectivity	22.0.0	Vendor to provide utility for converting the Cash Dispenser files, containing transaction details, into ASCII format.	Y	F/N			
ATM	Hardware	22.0.1	There should be 8 FDK keys with Braille Impressions (4 on either side of the Screen) for selecting the various options being displayed on the Screen.  The FDK can be optional. In case, the touch screen of the machine without FDK, is frequently down due to non-working of touch screen, then Vendor should replace the machine with the model which has FDK with Touch Screen or install FDK in the existing machine.	N	F/N/C			
MVS	MVS-APPL-TESTING	23.0.0	Vendor should arrange for OEM Vendor/Service Provider to deploy support team for testing at the ATM Test Lab for MVS required at no cost to the bank.	Y	F/C/N			
ATM	Location	24.0.0	The machine should have a self-powered GPS device within the machine, so that the machine can be tracked in case it has been uprooted and taken away. The GPS device should	N	F/C/N			

			<p>be capable of providing longitude and latitude coordinates.</p> <p>The GPS device should be integrated with the XFS layer so that its coordinates' data can be read through MVS.</p>					
--	--	--	---	--	--	--	--	--

## APPENDIX-C2 ATM SOFTWARE SPECIFICATIONS

Module	Item	Feature Id	Features	Mandatory	Validation Criteria (put anyone)	Response (YES / NO)	Map your Module	Give Page No. of RFP Submitted
SW	ATM-APPL-SWDIST	A1.1.0	Machine should be capable of centrally downloading Software / Patches upgrades and idle screen and content distribution when connected with Banks provided MVS software	Y	F/N			
SW	ATM-APPL	AA.1.1	Should have built-in eJ viewer with search facility	Y	F/N			
SW	ATM-APPL	AA.1.2	Should have eJ archival and retrieval facility	Y	F/N			
SW	ATM-APPL	AA.1.3	Should be capable of interface through multi-vendor ATM software agent on machine with Bank's Switches i.e., BASE24 or any other Switch introduced by the Bank in future and Multi-Vendor ATM Central Server.	Y	F/N			
SW	ATM-APPL	AA.1.4	ATM Application should be capable to interface with Bank's Switches i.e., BASE24 or any other Switch introduced by the Bank in future and MultiVendor Central Server	Y	F/N			
SW	ATM-APPL	AA.1.5	Software for reading the EMV Chip Cards. Smart Card/ chip Card EMV version 4.0, Level 2 approved	Y	F/N			

Module	Item	Feature Id	Features	Mandatory	Validation Criteria (put anyone)	Response (YES / NO)	Map your Module	Give Page No. of RFP Submitted
			terminal resident application.					
SW	ATM-APPL	AA.1.6	Remote diagnostic agent to diagnose problems with the machine including but not limited to predicting part failures. This service including proactive rectification of problems reported by remote diagnostic agent will have to be provided by the bidder / OEM mandatorily at no extra cost to the Bank. The bidder also agrees to install any software selected by the Bank at no cost to the Bank.	Y	F/N			
SW	ATM-APPL	AA.1.7	Response to the terminal from central solution should not be more than 500 milliseconds from the time of request originated at the terminal. In case of delay in response or no response from central Solution default transaction flow should be used.	Y	F/N			
SW	ATM-APPL	AA.1.8	Terminal solution should be the single intelligent application that controls devices/supports display on screen at terminal. Controls and supports	Y	F/N			

Module	Item	Feature Id	Features	Mandatory	Validation Criteria (put anyone)	Response (YES / NO)	Map your Module	Give Page No. of RFP Submitted
			multiple devices e.g., epp, dispenser, card reader etc					
SW	ATM-APPL	AA.1.9	Bidder to confirm ability to demonstrate proof of concept about ATM software being capable of supporting all the applications currently developed for the Bank such as ATM Locator, Railway ticketing, Campus fees payment, Mobile Recharge & other Utility Bill Payments.	Y	F/N			
SW	ATM-APPL	AA.1.10	Software to support DDC/912 or NDC message emulation.	Y	F/N			
SW	ATM-APPL	AA.1.11	Software to support IFX message emulation.	N	F/C /N			
SW	ATM-APPL	AA.1.13	Software to support ISO20022(XML) message emulation.	Y	F/N			
SW	ATM-APPL-TESTING	B.1.1	Vendor should arrange for OEM Vendor/Service Provider to deploy support team for testing at the ATM Test Lab whenever required at no cost to the bank.	Y	F/N			
SW	ATM-APPL-TXNTYP	C.1.1	Support Cash Withdrawal from any bank account (at least 6 accounts)	Y	F/N			

Module	Item	Feature Id	Features	Mandatory	Validation Criteria (put anyone)	Response (YES / NO)	Map your Module	Give Page No. of RFP Submitted
SW	ATM-APPL-TXNTYP	C.1.2	Support Standing Instruction	Y	F/N			
SW	ATM-APPL-TXNTYP	C.1.3	Support Loan Account enquiry	Y	F/N			
SW	ATM-APPL-TXNTYP	C.1.4	Support Fixed Deposit	Y	F/N			
SW	ATM-APPL-TXNTYP	C.1.6	Support Balance Enquiry	Y	F/N			
SW	ATM-APPL-TXNTYP	C.1.7	Support Mini-Statement	Y	F/N			
SW	ATM-APPL-TXNTYP	C.1.8	Support Card to Card Transfer	Y	F/N			
SW	ATM-APPL-TXNTYP	C.1.9	Support Card to Account Transfer	Y	F/N			
SW	ATM-APPL-TXNTYP	C.1.10	Support Account to Account Transfer	Y	F/N			
SW	ATM-APPL-TXNTYP	C.1.11	Support B 2 B	Y	F/N			
SW	ATM-APPL-TXNTYP	C.1.12	Support Visa Money Transfer	Y	F/N			

Module	Item	Feature Id	Features	Mandatory	Validation Criteria (put anyone)	Response (YES / NO)	Map your Module	Give Page No. of RFP Submitted
SW	ATM-APPL-TXNTYP	C.1.13	Support Biometric Based Authentication API v 2.0 specifications (as stated by UIDAI). Additional changes required to support later revisions to be provided at no cost to the bank.	Y	F/N			
SW	ATM-APPL-TXNTYP	C.1.14	Support Institutional Fee Payment	Y	F/N			
SW	ATM-APPL-TXNTYP	C.1.15	Support Utility/Bill Payment/Taxes/Trust Donation Etc.,	Y	F/N			
SW	ATM-APPL-TXNTYP	C.1.16	Support/ Display of graphics/ animation/ scrolling/ date & time	Y	F/N			
SW	ATM-APPL-TXNTYP	C.1.17	Support PIN Change	Y	F/N			
SW	ATM-APPL-TXNTYP	C.1.18	Support Fast Cash/My Favourite Option	Y	F/N			
SW	ATM-APPL-TXNTYP	C.1.19	Support Mobile Number Registration	Y	F/N			
SW	ATM-APPL-TXNTYP	C.1.20	Support Mobile Top-UP	Y	F/N			
SW	ATM-APPL-TXNTYP	C.1.21	Support Mobile Banking Registration/Deregistration	Y	F/N			

Module	Item	Feature Id	Features	Mandatory	Validation Criteria (put anyone)	Response (YES / NO)	Map your Module	Give Page No. of RFP Submitted
SW	ATM-APPL-TXNTYP	C.1.22	Support SBI Credit Card Bill Payment	Y	F/N			
SW	ATM-APPL-TXNTYP	C.1.23	Support SBI Credit Card Cash Withdrawal	Y	F/N			
SW	ATM-APPL-TXNTYP	C.1.24	Support Prepaid Card Cash Withdrawal	Y	F/N			
SW	ATM-APPL-TXNTYP	C.1.25	Support Prepaid Card Balance Enquiry	Y	F/N			
SW	ATM-APPL-TXNTYP	C.1.26	Support SBI Life Insurance Premium payment	Y	F/N			
SW	ATM-APPL-TXNTYP	C.1.27	Support Cheque Book Issuance	Y	F/N			
SW	ATM-APPL-TXNTYP	C.1.28	Support Stop Cheque enquiry	Y	F/N			
SW	ATM-APPL-TXNTYP	C.1.29	Support Internet Banking Request Approval	Y	F/N			
SW	ATM-APPL-TXNTYP	C.1.30	Support Aadhaar Number Seeding	Y	F/N			
SW	ATM-APPL-TXNTYP	C.1.31	Support Cash increase/decrease/short/excess Admin Transactions using admin card	Y	F/N			



Module	Item	Feature Id	Features	Mandatory	Validation Criteria (put anyone)	Response (YES / NO)	Map your Module	Give Page No. of RFP Submitted
SW	ATM-APPL-TXNTYP	C.1.32	Support Channel Manager visit registration	Y	F/N			
SW	ATM-APPL-TXNTYP	C.1.33	Support Dynamic Currency Conversion during transaction	Y	F/N			
SW	ATM-APPL-TXNTYP	C.1.34	Support Failure Alert	Y	F/N			
SW	ATM-APPL-TXNTYP	C.1.35	Support Idle Screen / Advertising	Y	F/N			
SW	ATM-APPL-TXNTYP	C.1.36	Supports for all available and proposed /advanced value-added services	Y	F/N			
SW	ATM-APPL-TXNTYP	C.1.37	Supports OTP Based and Cardless transaction withdrawals	Y	F/N			
SW	ATM-APPL-TXNTYP	C.1.38	Supports Virtual keyboard at ATM Screens for inserting alphanumeric text/numbers	Y	F/N			
SW	ATM-APPL-TXNTYP	C.1.39	Support QR code-based Transaction	Y	F/N			
SW	ATM-APPL-TXNTYP	C.1.40	Support Card less Transaction	Y	F/N			
SW	ATM-APPL-TXNTYP	C.1.41	Support NFC based transaction / contactless transaction	Y	F/N			

Module	Item	Feature Id	Features	Mandatory	Validation Criteria (put anyone)	Response (YES / NO)	Map your Module	Give Page No. of RFP Submitted
SW	ATM-APPL-TXNTYP	C.1.42	Support EMV-chip based transactions	Y	F/N			
SW	ATM-APPL-TXNTYP	C.1.43	Support for AKDS	Y	F/N			
SW	ATM-APPL-TXNTYP	C.1.44	Support for 3-DES	Y	F/N			
SW	ATM-APPL-TXNTYP	C.1.45	Support for supervisory mode cash counter update	Y	F/N			
SW	ATM-APPL-TXNTYP	C.1.46	Support Account Number Masking (on receipt)	Y	F/N			
SW	ATM-APPL-TXNTYP	C.1.47	Support 2-digit Screen for checking Keypad is working	Y	F/N			
SW	ATM-APPL-TXNTYP	C.1.48	Support Timed out and Last Transaction Status (LTS) based reversals	Y	F/N			
SW	ATM-APPL-TXNTYP	C.1.49	Support for MAC (Message Authentication Code)	Y	F/N			
SW	ATM-APPL-TXNTYP	C.1.50	Support 2048-bit or higher encryption standards	Y	F/N			
SW	ATM-APPL-TXNTYP	C.1.51	Support Instant Money Transfer Transaction.	Y	F/N			

Module	Item	Feature Id	Features	Mandatory	Validation Criteria (put anyone)	Response (YES / NO)	Map your Module	Give Page No. of RFP Submitted
SW	ATM-APPL-TXNTYP	C.1.52	Support for AES	Y	F/N			
SW	ATM-APPL-TXNTYP	C.1.53	Support for TLS1.2 or higher	Y	F/N			
SW	ATM-APPL-TXNTYP	C.1.54	Support Biometric based Registration	Y	F/N			
SW	ATM-APPL-TXNTYP	C.1.55	Customer preferences eg. Language, Fixed amount withdrawal etc	Y	F/N			
SW	ATM-APPL	D.1.1	Supports Windows 10 or the latest available Windows operating system	Y	F/N			
SW	ATM-APPL	D.1.2	Application interface facilitating all Admin, Reconciliation and MIS functions	Y	F/N			
SW	ATM-APPL	D.1.3	Provide Text-to-Speech (TTS) support in English, Hindi and regional languages	Y	F/N			
SW	ATM-APPL	D.1.4	Terminal should be capable to integrate with custom/3rd party Text-to-Speech (TTS) software.	Y	F/N			
SW	ATM-APPL-VSS	E.1.1	Solution to support capturing, storing and retrieval of pictures/ Video clips during the transaction at the terminal using proprietary and/or CEN XFS Compliant camera.( In	Y	F/N			

Module	Item	Feature Id	Features	Mandatory	Validation Criteria (put anyone)	Response (YES / NO)	Map your Module	Give Page No. of RFP Submitted
			case of proprietary camera solution, solution provider to develop/customize the camera solution using proprietary drivers and/or using proprietary camera application wherever available)					
SW	ATM-APPL-VSS	E.1.2	Proposed Solution should be capable of stamping the transaction information (with masking of Card Number as per PA-DSS) on the images / Video clipping.	Y	F/N			
SW	ATM-APPL-VSS	E.1.3	Customization if any with the OEM proprietary solution will be the sole responsibility of the Solution provider	Y	F/N			
SW	ATM-APPL	F.1.1	EJ format should be parameterized and on the standard format irrespective of make and model of the terminal, as per the requirement of the Bank.	Y	F/N			
SW	ATM-APPL-LANG	G.1.1	Multilingual support for all Official languages as declared by the Indian Constitution or by respective states in India as well as major foreign languages	Y	F/N			

Module	Item	Feature Id	Features	Mandatory	Validation Criteria (put anyone)	Response (YES / NO)	Map your Module	Give Page No. of RFP Submitted
SW	ATM-APPL-LANG	G.1.2	Screens	Y	F/N			
SW	ATM-APPL-LANG	G.1.3	Campaigns	Y	F/N			
SW	ATM-APPL-LANG	G.1.4	Receipts Printing	Y	F/N			
SW	ATM-APPL-LANG	G.1.5	Text Messages on Screens	Y	F/N			
SW	ATM-APPL-LANG	G.1.6	Audio support (Text to speech in preferred language)	Y	F/N			
SW	ATM-APPL-LANG	G.1.7	Disability compliance (Text to speech, longer timeouts, handset detection, FDK to numeric key detection.	Y	F/N			
SW	ATM-APPL-EPGEN	H.1.1	ATM Should be capable of integrating with any Endpoint Protection Solution, if any, available with the bank from time to time without any cost to bank	Y	F/N			
SW	ATM-APPL-EPWL	H.1.2	OEM's native ATM Application should be able to block USB ports on the ATM.	Y	F/N			

Module	Item	Feature Id	Features	Mandatory	Validation Criteria (put anyone)	Response (YES / NO)	Map your Module	Give Page No. of RFP Submitted
SW	ATM-APPL-EPSWL	H.1.3	OEM's native ATM Application should have firewall functionality.	Y	F/N			
SW	ATM-APPL-EPSWL	H.1.4	OEM's native ATM Application should issue alert/ warning once a threat has been identified	Y	F/N			
SW	ATM-APPL-EPSWL	H.1.5	OEM's native ATM Application should block unauthorized installed software.	Y	F/N			
SW	ATM-APPL-EPSWL	H.1.6	OEM's native ATM Application should have capability to allocate only required ATM resources to the whitelisted application. The application should monitor during the execution of the application that only whitelisted resources are accessed and log all events at the ATM Terminal.	Y	F/N			
SW	ATM-APPL-EPSWL	H.1.7	OEM's native ATM Application should be capable of integrating with Bank's provided single centralized management console for managing, administering and pushing the hardening policies .	Y	F/N			
SW	ATM-APPL-EPSWL	H.1.8	The OEM's native application should have hardening policies for ATM environment and should have out of box	Y	F/N			

Module	Item	Feature Id	Features	Mandatory	Validation Criteria (put anyone)	Response (YES / NO)	Map your Module	Give Page No. of RFP Submitted
			prefabricated best practices to reduce installation period without any additional cost to the Bank.					
SW	ATM-APPL-SWDIST	I.1.1	Vendor should arrange for OEM Vendor/Service Provider for image create for installation either at site directly or before dispatching machine to the installation site.	Y	F/N			
SW	ATM-APPL	I.1.2	Vendor should arrange for OEM Vendor/Service Provider to support all security review and testing provided by Bank as and when required without any extra cost to the bank.	Y	F/N			
SW	ATM-APPL	I.1.3	EMVCo Level 2 approved terminal application/kernel. On expiry of certificate, it should be replaced with valid certificate at no additional cost to the Bank during the currency of the contract.	Y	F/N			

## APPENDIX-C3 ATM SUPPORT Services

Module	Item	Feature Id	Features	Mandatory	Validation Criteria (put anyone)	Response (YES/NO)	Map your module	Give Page No. of RFP Submitted
MGD	CASH-MGMT	AD1.1.0	Tracking delivery of cash	Y	F/N			
MGD	CASH-MGMT	AD1.2.0	Tracking delivery of cash. Ability of MS tool to integrate with a generic tracking tool	Y	F/N			
MGD	CASH-MGMT	AD1.3.0	Analysis of cash usage and cash forecasting	Y	F/N			
MGD	CASH-MGMT	AD1.4.0	<b>Management Reports</b>					
MGD	CASH-MGMT	AD1.4.1	- Comparing historical data	Y	F/N			
MGD	CASH-MGMT	AD1.4.2	- Reporting of trends	Y	F/N			
MGD	CASH-MGMT	AD1.4.3	- Cost optimization	Y	F/N			
MGD	CASH-MGMT	AD2.1.0	ESR - Secure electronic interface between Management Centre, Bank and cash replenishment agencies	Y	F/N			



Module	Item	Feature Id	Features	Mandatory	Validation Criteria (put anyone)	Response (YES/NO)	Map your module	Give Page No. of RFP Submitted
MGD	CASH-MGMT	AD2.2.0	ESR - Standardized replenishment data & mechanism to ensure consistent/timely movement of data	Y	F/N			
MGD	CASH-MGMT	AD2.3.0	ESR - Consolidate Settlement and Reconciliation reports across multiple service providers	Y	F/N			
MGD	CASH-MGMT	AD2.4.0	ESR - Identify discrepancies, missed settlements and other performance issues	Y	F/N			
MGD	CASH-MGMT	AD2.5.0	ESR - Consolidate vault reconciliation reports, settlement reports and bulk cash acknowledgements	Y	F/N			
MGD	OTC-MGMT	AE1.0.0	Centralized Control from Management Centre	Y	F/N			

Module	Item	Feature Id	Features	Mandatory	Validation Criteria (put anyone)	Response (YES/NO)	Map your module	Give Page No. of RFP Submitted
MGD	OTC-MGMT	AE1.1.0	Centralized control capability to monitor & control exactly who may access a particular safe & when	Y	F/N			
MGD	OTC-MGMT	AE1.2.0	Access control to ensure only authorized users gain time based access to safe.	Y	F/N			
MGD	OTC-MGMT	AE1.3.0	Capability to take over One Time Combination (OTC) password generating process for CIT agency and to take physical control of the ATM/CD/CDM/ Recyclers, when required.	Y	F/N			
OATS	DIST-MGMT	AF1.0.0	Software & screen distribution from a central source to facilitate individual configuration & screen displays	Y	F/N			
OATS	DIST-MGMT	AF1.2.0	Scheduling download and installation at desired times	Y	F/N			
OATS	DIST-MGMT	AF1.3.0	Scheduled and ad hoc/immediate upload of eJournals	Y	F/N			
OATS	DIST-MGMT	AF1.4.0	Monitoring Job status online	Y	F/N			

Module	Item	Feature Id	Features	Mandatory	Validation Criteria (put anyone)	Response (YES/NO)	Map your module	Give Page No. of RFP Submitted
MGD	NTWK-MGMT	AG1.4.0	Use reliable, dedicated IP connection with backup	Y	F/N			
MGD	NTWK-MGMT	AG2.2.0	Notify appropriate agency for activating support	Y	F/N			
MGD	NTWK-MGMT	AG2.3.0	Notify customer at detection, isolation and resolution	Y	F/N			
MGD	NTWK-MGMT	AG2.4.0	Manage incident from detection to resolution	Y	F/N			
MGD	NTWK-MGMT	AG3.1.0	Proactive/predictive analysis & recommendations	Y	F/N			
MGD	NTWK-MGMT	AG3.2.0	Setting event thresholds based on customer availability needs	Y	F/N			
MGD	NTWK-MGMT	AG3.3.0	Tuning performance by correlating events with performance metrics	Y	F/N			
MGD	NTWK-MGMT	AG3.4.0	Order to identify bottlenecks that inhibit availability and performance	Y	F/N			
OATS	NTWK-MGMT	AG4.2.0	Remotely implement software upgrades	Y	F/N			
MGD	NTWK-MGMT	AG4.3.0	Maintain password ownership of	Y	F/N			

Module	Item	Feature Id	Features	Mandatory	Validation Criteria (put anyone)	Response (YES/NO)	Map your module	Give Page No. of RFP Submitted
			configurable managed objects					
OATS	NTWK-MGMT	AG4.4.0	Implement logical changes to remotely configurable devices	Y	F/N			
OATS	NTWK-MGMT	AG4.5.0	Report metrics including device class, location, IP address, circuit information	Y	F/N			
MGD	NTWK-MGMT	AG5.2.0	Update customer help desk about estimated service restoration time	Y	F/N			
MGD	NTWK-MGMT	AG5.3.0	Monthly report on fault, performance and configuration metrics	Y	F/N			
MGD	NTWK-MGMT	AG5.4.0	Interpret metrics & make recommendations for improvement	Y	F/N			
MGD	NTWK-MGMT	AG6.1.0	24 X 7 X 365 monitoring and resolution	Y	F/N			
MGD	NTWK-MGMT	AG6.2.0	Unlimited incidents	Y	F/N			
MGD	NTWK-MGMT	AG6.3.0	Toll free number with multiple lines for service requests (minimum 100 lines)	Y	F/N			

Module	Item	Feature Id	Features	Mandatory	Validation Criteria (put anyone)	Response (YES/NO)	Map your module	Give Page No. of RFP Submitted
MGD	NTWK-MGMT	AG7.1.0	Call to Network service Provider and SMS/EMAIL to Bank with in 3 minutes fault occurrence.	Y	F/N			
OATS	NTWK-MGMT	AG7.2.0	Remedial remote diagnostics typically performed within 3 minutes	Y	F/N			
MGD	DATA-SEC	AH.1.0	IPSEC on circuits that connect the Bank to the vendor's Management Centre	Y	F/N			
MGD	DATA-SEC	AH.2.0	Secure Shell Security (SSH), TLS 1.2 or whichever is higher security protocol between Bank's ATM switch and Incident Management system/Banks Monitoring System.	Y	F/N			
MGD	DATA-SEC	AH.3.0	Secure Socket Layer (SSL), TLS 1.2 or whichever is higher security protocol between the Bank and Secured web server.	Y	F/N			
MGD	DATA-SEC	AH.4.0	Firewall - Fully integrated Internet security and IP	Y	F/N			

Module	Item	Feature Id	Features	Mandatory	Validation Criteria (put anyone)	Response (YES/NO)	Map your module	Give Page No. of RFP Submitted
			networking on one purpose-built platform					
MGD	DATA-SEC	AH.5.0	Firewall - Access to network always available with VRRP and Firewall synchronization technology	Y	F/N			
MGD	DATA-SEC	AH.6.0	Firewall - Networking OS integrated with third party applications designed for security solutions	Y	F/N			
MGD	DATA-SEC	AH.7.0	Intrusion Detection System	Y	F/N			
MGD	DATA-SEC	AH.8.0	The bidder /supplier should support the endpoint protection solution available/provided by the Bank. In case Bank decides to use OEM native application at ATM, Bidder/supplier should provide Virus Protection, Detection and Maintenance of Virus definition.	Y	F/N			
MGD	DATA-SEC	AH.9.0	Should have a Information Security Management System which is established using best practices	Y	F/N			

Module	Item	Feature Id	Features	Mandatory	Validation Criteria (put anyone)	Response (YES/NO)	Map your module	Give Page No. of RFP Submitted
			available in industry (e.g. ISO 27001) operational, continuously monitored and improved					
MGD	DATA-SEC	AH.10.0	Logging should be done for user account management, privilege changes, user activity, configuration changes etc.	Y	F/N			
MGD	DATA-SEC	AH.11.0	Adequate redundancy and back up – DR site to support uninterrupted services	Y	F/N			
MGD	HELP-DESK	AI.2.0	Toll free telephone number with multiple lines (minimum 100)	Y	F/N			
MGD	HELP-DESK	AI.3.0	Must be the single point of contact for Bank for help, checks on status of an ATM problem, Kiosk/kiosk equipment problems, managing multiple parties to resolve problems	Y	F/N			
MGD	HELP-DESK	AI.4.0	Receive telephone call from external customer, identify the caller, log and create the incident ticket and	Y	F/N			

Module	Item	Feature Id	Features	Mandatory	Validation Criteria (put anyone)	Response (YES/NO)	Map your module	Give Page No. of RFP Submitted
			assign the incident priority					
MGD	HELP-DESK	AI.5.0	Supplemental support for variations in business patterns	Y	F/N			
MGD	HELP-DESK	AI.8.0	Proactive problem resolutions	Y	F/N			
MGD	HELP-DESK	AI.9.0	Coordination/management of multi-vendor support	Y	F/N			
MGD	HELP-DESK	AI.10.0	Round-the-clock remote support to all field engineers and customers in India	Y	F/N			
MGD	REQS	AI.11.0	Services will be provided on 24x7x365 basis	Y	F/N			
MGD	FLM-REQS	AJ.1.0	Keeping a written maintenance log at the site. The Bank shall use the same log for recording nature of faults/failures observed, date and time of their occurrence and communication to vendors	Y	F/N			
AMC	FLM-REQS	AJ.2.0	Only qualified maintenance personnel familiar with the equipment shall	Y	F/N			



Module	Item	Feature Id	Features	Mandatory	Validation Criteria (put anyone)	Response (YES/NO)	Map your module	Give Page No. of RFP Submitted
			perform all repairs and maintenance services					
MGD	FLM-REQS	AJ.3.0	Scheduled visits for checking site's condition in respect of door, door handle, external glass, visual merchandise, access lock, electrical fittings, earthing, AC, UPS and its batteries, electrically-lit signage, painting & other civil requirements, etc. (The list is illustrative and not exhaustive).	Y	F/N			
MGD	FLM-REQS	AJ.4.0	Supply and replenish receipt printer should print approx 5 million characters)	Y	F/N			
MGD	FLM-REQS	AJ.5.0	Supply and replenish receipt printer rolls customized as per Bank's requirements. One side of the roll will have to be pre-printed with text provided by the Bank and printing at the ATM will be only on the blank side. Print matter may be changed as and when required.	Y	F/N			

Module	Item	Feature Id	Features	Mandatory	Validation Criteria (put anyone)	Response (YES/NO)	Map your module	Give Page No. of RFP Submitted
MGD	FLM-REQS	AJ.6.0	Receipt Rolls – 80mm wide x 8” dia approx x 0.7” core dia produced on ATM grade thermal paper Appleton Alpha 8. The density of sense mark should be uniform with 1.2 plus & tolerance level of slitting should be +/- 0.012”	Y	F/N			
MGD	FLM-REQS	AJ.7.0	Should supply for all ATMs on Bank’s network without limitation on quantity	Y	F/N			
MGD	FLM-REQS	AJ.8.0	Consumable management shall be independent of ATM make, model, type of network and vendor	Y	F/N			
MGD	FLM-REQS	AJ.9.0	Consumables replenishment to be initiated proactively to ensure ATM does not go down for want of these items	Y	F/N			
MGD	FLM-REQS	AJ.10.0	Clearing receipt paper jams. Clearing of card jams.	Y	F/N			
MGD	FLM-REQS	AJ.11.0	The vendor should arrange to get publicity materials, banners, posters etc. supplied	Y	F/N			

Module	Item	Feature Id	Features	Mandatory	Validation Criteria (put anyone)	Response (YES/NO)	Map your module	Give Page No. of RFP Submitted
			by the Bank displayed in the kiosks as per instructions besides replenishing leaflets, brochures etc.					
MGD	CASH-REPL	AK.1.0	Should have own arrangements or with reputed cash-in-transit agencies	Y	F/N			
MGD	CASH-REPL	AK.2.0	Vendor / Cash-in-transit agencies should have operational experience in handling ATM cash replenishment	Y	F/N			
MGD	CASH-REPL	AK.3.0	Should have vault, security guards and other necessary infrastructure	Y	F/N			
MGD	CASH-REPL	AK.4.0	Should have insurance for activities undertaken. Should have 100 % insurance cover for the cash retained in the vault as well as cash-in-transit	Y	F/N			
MGD	CASH-REPL	AK.5.0	There should be no cap to the number of cash runs performed per day / month	Y	F/N			

Module	Item	Feature Id	Features	Mandatory	Validation Criteria (put anyone)	Response (YES/NO)	Map your module	Give Page No. of RFP Submitted
MGD	POWER	AL.1.0	Input and Output Voltage of UPS should be checked	Y	F/N			
MGD	POWER	AL.2.0	Input and Output Current of UPS should be checked	Y	F/N			
MGD	POWER	AL.3.0	Input frequency of UPS should be checked	Y	F/N			
MGD	POWER	AL.4.0	Battery Life of UPS should be checked	Y	F/N			
MGD	POWER	AL.5.0	Battery Voltage of UPS should be checked	Y	F/N			
MGD	POWER	AL.6.0	Internal Temperature of UPS should be checked	Y	F/N			

## Appendix-C4 – Specifications of UPS & BATTERIES:

### UPS & Batteries

- The UPS & Batteries are to be kept in Back room. A back room required for keeping all peripherals like UPS, Batteries, Modems, e-Surveillance panels etc.
- The battery back-up capacity will depend on the main power supply in that area.
- UPS should have Simple Network Management Protocol (SNMP) for polling, wherever SNMP cards are provided for UPS and necessary feed is received.

Description	Make
<p>2 KVA UPS with at least 8 hours Fast Charging SMF / Lithium-ion batteries back up.                      Microprocessor / DSP based Online UPS 2 KVA Single Phase with Isolated output, SNMP enabled with Software to facilitate completion of last transaction before gracefully shutting down the CD.                      Technical Specifications:                      Input Voltage Tolerance: 120-290 V.                      Input Frequency Tolerance: 47Hz to 53Hz                      Output Voltage: 230 V +/- 1% No Load to Full Load.                      Output Frequency: Mains Synchronised / 50Hz+/- 0.05% in free running mode.                      Overall efficiency: &gt; 90% AC to AC.                      Recharge Time: &lt; 12 Hours up to 90% Capacity.                      Overload Capacity: 110% for 1Minute, 130% for 1Sec                      Total Harmonic Distortion: &lt; 4%,                      Output Filtration: RC &amp; EMI                      Protections: Short Circuit, Overload, Low Battery, Over Charge.                      With Audible Alarm for low battery and inverter trip.                      Temperature tolerance: 10 to 45 degree C for the UPS                      Humidity tolerance: &lt;= 90% non-Condensing                      Indications Digital Display:                      AC I/P O/P Voltage, AC I/P O/P Current, DC Voltage, DC Current &amp; Battery Status                      Special Requirement: Auto restart at Mains after Low Battery or Overload, Cold start at 90% of the rated load.                      8 hours battery back-up. Min VAH: 8600.</p>	<p>Numeric, Epoch, Novateur, Tritronics, APC, DB, Emerson, E &amp; C, Techser, Aplab or of any equivalent make and having a good service network across the country.                      SMF / Lithium-ion batteries of Hitachi, Rocket, Panasonic, Exide powersafe, AmaraRaja, Amco Best, Numeric, U_PLUS, HBL, CSB, Newmax (all with 18 months warranty) or of any equivalent make and having a good service network across the country.</p>

## **Appendix-D** **BIDDER DETAILS**

### Details of the Bidder

S. No.	Particulars	Details
1.	Name	
2.	Date of Incorporation and / or commencement of business	
3.	Certificate of incorporation	
4.	Brief description of the Bidder including details of its main line of business	
5.	Company website URL	
6.	Company PAN Number	
7.	Company GSTIN Number	
8.	Particulars of the Authorized Signatory of the Bidder a) Name b) Designation c) Address d) Phone Number (Landline) e) Mobile Number f) Fax Number g) Email Address	

**Name & Signature of authorised signatory**

**Seal of Company**

## Appendix-E

### SCOPE OF WORK

**Please Note:**

- I. **The Engagements under this Request for Proposal (RFP) for 13,500 Offsite ATMs on Per Successful Transactions Rate Basis, under Total Outsourced Model (TOM) with the scope for upto 25% (+ or -) Buffer Quota and will be for the period of 07 (Seven) years (2557 days) from the date of execution of Agreement, which can be extended upto 10 years (i.e., upto another three years in one or more tranches after base 7 years period) at the sole discretion of the Bank and such extension, if any required by Bank, shall be binding to selected bidders.**
  - II. **Bank shall be paying to Vendors Per Successful Transaction Basis and all arrangements under this RFP and Scope of work shall be made by Successful Bidders at their own cost.**
  - III. **Vendor and / or its sub-contractors shall comply with all statutory, regulatory provisions, relevant laws, guidelines, advisories etc., time to time framed by the Central Government / State Government / Local Bodies / RBI / MHA / IBA or any other statutory authority(s), including but not limited to Shops & Establishment Act, Minimum Wages Act, Contract Labour, Tax laws, all laws pertaining to contract employees required for providing the Services including Caretaker Services etc. and undertakes to keep the Bank indemnified against any such default (s) of his obligations under the compliance of such laws during the full contract period.**
  - IV. **All existing Compliances of Guidelines /Advisory/ Orders/ Instructions/SOP issued by Bank, State / District / Local Administration / GoI / IBA / RBI / MHA / NPCI or any other statutory authority etc. must be followed ab initio by successful bidders for each machine / site for all works / services under this RFP. Any **new** future guidelines /advisory by any statutory / **regulatory** authority shall be complied **without any cost to the Bank with mutually agreed terms & conditions and within the timeline advised by the authority.** Few illustrative but not exhaustive guidelines are as under: -**
- a) **For terminal Security of CD, Cyber Security and IT Examination Cell (CSITE), RBI Advisory No.3/2017 dated 06.03.2018, Circular RBI/2017-18/206 DBS (CO). CSITE/BC.5/31.01.015/2017-18 dated 21st June 2018.**
  - b) **For EMV Compliance of endpoint, RBI NOTIFICATION No. DPSS.CO.PD No.1298/02.10.002/2017-18; 30th Oct 2017.**

- c) For Anti skimming devices to be installed in all CDs, RBI advisory no.13/2017 dated 01.11.2017.
- d) RBI Advisory 14/2017 dated 06.12.2017 on Securing the Ecosystem connecting the Bank's ATM switch to Card Networks.
- e) For cassette swaps in ATMS RBI Circular RBI/2017-18/ DCM (Plg.) No.3641/10.25.007/201/2017-18 dated 12th April 2018
- f) Circular no. RBI/2017-18/152 (DCM (Plg) No.3563/10.25.07/2017-18) dated 06- 04-2018 on Cash Management activities of the banks - standards for engaging the service provider and its sub-contractor.
- g) Gazette Notification issued by Ministry of Home Affairs, New Delhi on 8th Aug. 2018 for Cash Management Agencies.
- h) Circular no. DCR.No.BP.BC.76/21.04.158/2014-15 dated March 11,2015 - Guidelines on Managing Risks and Code of Conduct in Outsourcing of Financial Services by Banks. RBI/2018-19/183 DCM (Plg) No.2746/10.25.07/2018-19 May 14, 2019 on Outsourcing of Cash Management – Reconciliation of Transactions.
- i) Circular no. RBI/2018-19/214 DCM (Plg.) No.2968/10.25.007/2018-19 dated June 14, 2019 on E-surveillance, OTC locks & Grouting.
- j) RBI / Circular No. RBI/2019-20/130 DBS(CO). CSITE/BC.5/31.01.015/2019-20 dated 31.12.2019 on Cyber Security controls for Third Party ATM Switch Application Service Providers.
- k) "Voice Guidance Support for the visually challenged should be strictly as per the IBA Guidelines issued in this regard vide circular No. CIR/RB/ATMVCP/6846 Feb. 27, 2013 and subsequent changes, if any." Voice guidance should be in English, Hindi and all major Indian Regional Languages included in Schedule VIII of Indian Constitution.
- l) Manage/ perform the RD services (Device Registration, Key- Exchange/ Rotation Activity, etc.) as per the guidelines or directives received from UIDAI titled "AADHAAR REGISTERED DEVICES TECHNICAL SPECIFICATION - VERSION 2.0 (REVISION 1)" dated February 2017 or any amendments/ updates thereto, instructions/ guidelines of UIDAI/ RBI/ IBA regarding biometric authentication, in relation to the Fingerprint Biometric devices supplied with the ATMs/ CDs for the length of the contract, at no additional cost to the Bank etc.) for the RD services (incl. Key – Exchange / Rotation) is to be provided and maintained by the



Endpoint Provider/ OEM, at no additional cost to the Bank. The infrastructure (HW, SW, HSM, etc.) for the RD services (incl. Key-Exchange/ Rotation) is to be provided and maintained by the OEM, at no additional cost to the Bank.

- m) Vendor should comply all the formats of reports, reconciliation certificate, Electronic Journal, Receipts etc. as required by Bank, RBI, Govt etc.
- n) RBI Cash out Penalty: RBI / 2021-22 / 84 – DCM (RMMT) No. S153 / 11.01.01 / 2021-22 dated 10.08.2021.
- o) RBI Master Circulars on Detections & impounding of Counterfeit Notes.

1. **INSTALLATION OF BRAND-NEW ATMS:**

a) Bidder is responsible for procurement, installation and maintenance of ATMs as per the Technical Specifications mentioned in this RFP document under **Appendix-C**.

b) Bidder should provide all new ATMs (not refurbished) with biometric functionality of a particular OEM and particular model with OEM Native application.

c) The ATMs should be maintained by the Bidder / Vendor for the contract period of 7 years (2557 days) which can be extended upto 10 years (i.e., upto another three years in one or more tranches after base 7 years period), at the sole discretion of the Bank. The AMC shall be carried out by OEM or its authorized dealers for a period not less than 7 years and extensions thereof.

d) Cash Replenishment Services / Cash Evacuation Services with lockable cassettes swap method (mandatory ab-initio) for all machines, usage of OTC (One time Combination) in vault locks of machines ab-initio. Vendors to arrange and maintain (including replacement of faulty ones) for all set(s) of lockable cassettes + reject / retract / counterfeit bins, as and when required, during the entire contract period and extensions thereof.

e) ATMs should be capable of running Multi-vendor Software (MVS) and Endpoint Security Solution (EPS) implemented by the Bank in all its ATMs without any hardware changes. The Endpoint Provider will be responsible for testing, integration, commissioning and coordinating implementation of the MVS & EPS, in the ATMs to be supplied by the successful bidder(s), without any extra cost to the Bank, as per requirement(s) of the Bank.

f) Bidders should offer model of ATMs with the Operating System Windows 11 and CEN XFS 3.1 or higher compliant layer, that is state of the art machines capable of running the Bank's Multi-Vendor Software and Endpoint Protection Solution and which will have to be supported for a minimum period of 7 years after installation / operationalization, extendable up to a period of 10 years at the discretion of the Bank. The Bank wants advanced, multifunctional, energy-efficient system. In case, endpoint with Windows 11 is not ready, bidder can submit the bid for model compatible with Windows 10 IoT Enterprise 2019 or above (with a license of Windows 11) subject to condition that endpoint supplied / installed should be upgraded with Windows 11 before end of life for Windows-10 by Microsoft without any cost to the Bank.

g) If during the Contract period and extensions thereof, an endpoint is frequently becoming out of order for technical reasons for more than three times in a month and for two consecutive months, the Bank may ask the bidder to replace the endpoint with another new endpoint of same model & make with exactly same technical specifications as tested in the SBI ATM-Lab before the commencement of rollout under this RFP, at no extra cost to the Bank. The selected bidder should update / supply / install necessary changes in endpoint, if any, due to regulatory compliance, the same should be available at no additional cost to the Bank irrespective whether it being minor or major modifications.

h) **BIOMETRIC READERS / DEVICES:**

- i. Endpoint Provider providing the Fingerprint Biometric device will also need to manage / perform the RD services (Device Registration, Key-Exchange / Rotation Activity, etc.) as per the guidelines or directives received from UIDAI titled "AADHAAR REGISTERED DEVICES TECHNICAL SPECIFICATION - VERSION 2.0 (REVISION 1)" dated February 2017 or any amendments/ updates thereto, and any other instructions/ guidelines of UIDAI/ RBI/ IBA regarding biometric authentication, in relation to the Fingerprint Biometric devices supplied with the Endpoints for the length of the contract, at no additional cost to the Bank etc.) for the RD services (incl. Key - Exchange/ Rotation) is to be provided and maintained by the Endpoint Provider/ OEM, at no additional cost to the Bank. The infrastructure (HW, SW, HSM, etc.) for the RD services (incl. Key-Exchange/ Rotation) is to be provided and maintained by the Bidder, at no additional cost to the Bank.
- ii. Bidder to provide all Licences, updated Softwares and OEM support required for the development, testing, and implementation of any feature using the Biometric Devices, without any cost to the Bank.

i) All endpoints should have anti-skimming devices / solutions, anti-shimming devices / solutions, anti-deep-insert-skimmers, any other device or



solution etc. to prevent unauthorized reading and copying of card data (of card's magstripe or chip) from card-reader and contactless card reader, biometric data from biometric reader. Bidder to ensure that no cloning of card data to occur through machine. Bidder to upgrade the physical devices / components and applicable softwares / drivers whenever released by OEMs, without any cost to Bank. Any loss of the Bank in this regard shall be completely borne by the bidder. The Bank shall issue Letter of Intent / Confirmation Letter for installation of any such upgraded hardware / physical devices / components and applicable software or any standalone software after duly testing at its ATM-Lab. The rollout / installation of the upgrade (hardware and / or software, as applicable) should be done within the timeframe specified in the Letter of Intent / Confirmation Letter. A penalty of Rs.1,000 per day per non-complied machine shall be imposed for delay beyond the specified timeframe or for non-compliance of the Letter of Intent / Confirmation Letter.

j) All endpoints should be able to give the status of cash dispensed or not dispensed with 100% surety and the same should be recorded in the Electronic Journal (eJ) / machine logs / System log / switch. Internal Cash slot camera should be present to capture the movement of cash. Video / Image analytics or algorithms can be developed to ascertain the dispensation of cash. Failure to determine the cash dispensation status, the disputed amount / chargeback claim with any penalty imposed on Bank for that disputed transaction, if any, involved in such un-sure transactions will be made good by the vendor. The Bank shall support the bidder, at its own discretion, for any development required in Bank's MVS Solution or Bank's Switch. In case of any incorrect dispensation due to faulty functioning of the machine, the vendor should make good the loss within 30 days from the date of reporting of incidents and take corrective measures immediately. The Bank should not suffer loss due to any defect of the machine. The Bank's decision with regard to faulty functioning of the machine will be final and binding on the bidder. In case the defect resolution requires development / R&D (Research and Development) from OEM of the endpoint, the bidder should ensure that the OEM does the required development within the stipulated time agreed by the Bank. A penalty of Rs. 1,000 per day per non-complied machine shall be applicable for delay after the agreed stipulated timeframe.

k) There shall be SBI's YONO branding colour scheme on the facia of the machine. The facia / body should be factory painted in the SBI INK BLUE COLOUR (L481-105899 / RGB 40-0-113 / Hex #280071) scheme and YONO PRINTED vinyl wraps SHOULD BE STUCK ONTO THE MACHINES. The acrylic parts should be of the single SBI Blue colour specified in the RFP. The visible screen, keypad, front console can be as per OEM's default colour. The final colour appearance will be discussed with the successful bidders before implementation & rollout. The successful bidders should provide a 3D model

representation for visualization and clarity. The Bank's decision will be binding on the successful bidder. The final appearance will be decided by the Bank after taking into consideration the 3D model. There should not be fading or torn off vinyl wraps and their replacements to be done by the bidder on their own without waiting for Bank's intimation. If such replacement is advised by the Bank, it should be completed by the bidder within 5 days of intimation. Penalty @ ₹ 100 per day from the 6th Day onwards per non-complied ATM will be levied.

Indicative picture below: -

Chest Design	Overall	Side facia of machine
		

l) All Endpoints should be enabled for the Divyangjan so that the Endpoint must be suitable for the Divyangjan persons. All endpoints must also be suitable for wheelchair-based operations by physically challenged persons. Voice Guidance Support for the visually challenged should be strictly as per the IBA Guidelines and Bank's instructions issued in this regard. The Voice Guidance support should be available in Regional Languages (as & when required by the Bank) apart from English and Hindi. All the sites need to be provided with ramps for the handicapped, wheel-chair-based customers as per RBI guidelines and as per the specifications provided in the "ATM room Guidelines" mentioned in this RFP. The ATMs should have Braille Pin Pads and Braille FDKs (if present). Braille embossing should be on each key. Example of Braille Pin Pad: -



m) Endpoints with technology and functionalities like touch screen, Triple DES enabled, EMV certified dip smart card reader, etc. should be supplied and installed at sites.

n) Vendor should make arrangement for Installation and maintenance of UPS with minimum 8 hours fast charging SMF / Lithium-ion battery backup. However, it is responsibility of the Vendor to arrange for uninterrupted power supply for ATM functioning. In areas where there is load shedding, the Vendor should arrange for alternate Power supply arrangements like DG set, solar power, etc. The UPS should be integrated with the Endpoint such that the Endpoint is able to: -

- i. Distinguish power supply from Mains or UPS.
- ii. Shut down / sleep / hibernate gracefully (after completing any on-going transaction) when running on UPS power and the UPS battery charge is low (say 10%- or 15-minutes available backup). Endpoint should be able to “wake-up” and start working automatically when adequate charge is available, or mains power restored.
- iii. Record the power events in eJ / machine logs / system logs.
- iv. Monitor the power status (voltage / current etc.), UPS Battery percentage.
- v. Should be able to switch to UPS Power from Mains power when Mains power is fluctuating / low voltage etc. and back to mains power when its stable. The intension is to protect machine from power surges etc.
- vi. The above functionalities to be tested in the ATM Lab, so the UPS with minimum 8 hours fast charging SMF / Lithium-ion battery to be provided along with the machine.

o) Bidders shall indicate the upgrade options available for various models of endpoints. Machine should be capable of central upload / download.

p) Endpoints need to be energy efficient. The ATMs to be supplied have to be fully functional in extreme weather conditions (Temperature: 0 to plus (+)50 degree Celsius (Without air conditioner), Relative humidity: 5% to 95% (Without air conditioner), dust, etc.) within the country.

q) The vendor will ensure that at the time of delivery of ATMs they are not affected by virus / malware and will ensure that the vendor's employees attending to the ATMs during warranty period / AMC period do not introduce virus / malware and in the case of any dispute Bank's decision will be final.

r) **Grouting of Endpoints:** Selected bidder will have to necessarily install endpoint with good quality grouting of ATMs, as under:

"Moving / tilting of endpoint for removing existing levelling screws. Drilling 8"-10" holes in the existing flooring using concrete drill bits. Hammering metal sleeves in these holes. Repositioning the Endpoints over the existing markings. Putting in Anchor fasteners - min. 6" long anchor fasteners, preferably of Fischer make. Applying resin adhesive (Araldite) over the finished bolt positions for improved bonding & repairing broke tiles, if any".

s) ATMs deployed should comply with GOI, RBI, IBA, EMV, NPCI / NFS guidelines etc. If any new guidelines are issued by these organizations, the bidder / vendor shall arrange for its compliance / upgradation and bear the cost for the same. All upgradations (including but not limited to Security, network, site related digital security) will be done by the vendor free of cost. Any new type of Hardware (with associated software / drivers for that Hardware) in the endpoint will be done at mutually agreed price between the Bank and the vendor. For example, if the endpoint needs to be installed with extra Hardware such as QR code reader, Bar code reader, ink-stain technology in cassettes etc., as per regulatory guidelines, such installations can be done at mutually agreed price between the Bank and the vendor. If the endpoint needs to be upgraded on operating system or any other component etc. which is already a part of the end point (like RAM, card reader, anti-skimming solutions, Biometric, contactless reader, new features in DVSS cameras etc.), this must be done by the vendor free of cost.

t) The Bank desires to install endpoints with the latest technologies. The Bidder is liable to bear the full cost of upgrading the Hardware, Software (including Operating System) for any future Operating System Patch, Operating System Upgrade, security patches, Regulatory compliances etc. which require the Hardware or Software of the endpoint to be upgraded. All Such upgrades shall be without any additional cost to the Bank for the entire contract period of 7 years and extensions thereof. Non-compliance by bidders shall attract penalty of ~~Rs. 5,000~~ ₹1,000/- per day per endpoint from the end date advised by the Bank for compliance. Therefore, it is recommended that bidders install endpoints with higher configurations than the minimum specifications mentioned in this RFP.

u) One machine of One model of each OEM to be supplied under the contract

to be provided by the vendor free of cost for testing.

v) Bidders should note that ATMs will be deployed across the length and breadth of the country as per requirements of business and the bidder will have to guarantee that support will be available for the ATMs across the country.

w) Vendor to replace Old / Vandalized / Non-working / Problematic machine within 30 days from the date of communication by Bank or date of incident (whichever applicable) with a new one, without any cost to the Bank. **Reasonable relaxation in time may be provided by Bank, where the site is sealed by Law-enforcement Agency(ies).** Whenever such machine is being replaced with a new one, the following should be facilitated by the Vendor: -

- i. **Harddisk** of old machine should be taken over in the custody by the owner Branch & preserved in an envelope with the details of the machine written on the envelope like Terminal ID, its Serial Number, OEM Make, Vendor Name, Site Address, Date of Handover, Last transaction date of the machine, Disposal date (180 days from Handover date) etc. (format in Annexure-7). The Harddisk to be kept in Branch Custody for 6 months i.e., 180 days from the handover date. Details of the Harddisk to be entered into the Branch Document Register and shall be subjected to audits. After disposal date, if there is no customer disputed transaction data in the harddisk, it should be degaussed after permission from Branch Manager and disposed off as per the e-waste policy. Degaussing is simply a demagnetizing process to erase a harddisk. It is required to keep the harddisk for 180 days since that Harddisk contains the EJ, DVSS Images, machine logs etc. of the machine which may be required to resolve customer disputed transactions. The Harddisk to be retained beyond 180 days in case it contains the details of any disputed transaction logs / images / eJ till that disputed transaction is resolved. Hence before degaussing and disposal, Branch should check for any disputed transactions from Complain Management Dept.
- ii. **Encrypted Pin Pad (EPP) of old machine:** - The EPP of the old machine should be broken off in front of Bank Official and disposed off as per e-waste policy immediately. No need to retain the EPP. (Format in Annexure-7)
- iii. **Terminal Master Key (TMK)** will be entered by the Bank Official in the machine to operationalize the new machine which is replacing the older one.
- x) It is the responsibility of the vendor to change / upgrade / customize the infrastructure at all levels (like software, hardware supplied to Bank, Infrastructure at Management Centre, ATM site etc.) for ensuring the

compliance to statutory, Gol, RBI, IBA, MHA, Local Administration and VISA / MasterCard / NPCI etc. requirements at no additional cost to the Bank.

- y) Bank reserves the right to close the machine at its discretion for non-compliance of regulatory guidelines.
- z) If in case, the Bank desires to run ATMs on native application instead of MVS, bidder will provide native software, electronic Journal (ej) services, others related services, without any cost to Bank.
- aa) Successful bidder shall submit Installation certificate as per Appendix-T.
- bb) Bidder should set a unique BIOS Password for each ATM and change it regularly as per Bank's IS Policy. The custody of BIOS Password rests with the bidders. The risk & liability associated with BIOS Password compromise rests with the bidders. In an event of unauthorized access / event e.g.: Boot setting is changed using compromised BIOS password, resulting in terminal going down, will rest with the bidders. SOP for setting up BIOS Password shall be shared with the successful bidders only.

### **1.1 Testing of Endpoint at LAB:**

Selected bidder(s) will have to make available the following at Bank's ATM Lab during the term of the contract:

- a) One endpoint of one model of each OEM to be supplied with at least 2 Hard Disks (HDD), under this RFP and 2 UPSs with minimum 8 hours backup power through fast charging SMF / Lithium-ion batteries (UPS + batteries will be tested for the desired Integrated Power Management feature), without any additional cost to the Bank.
- b) Services of sufficient number (as required by Bank) of experienced and qualified resident engineers with full knowledge of technical aspects of ATMs (eg. Any functionalities, security testing, software testing, integration testing, interface testing, support UAT etc.) required by the Bank during the general shift on all days (10.30 am to 7.00 pm with half an hour recess) during the term of contract. In exceptional circumstances, services should be available for extended working hours to meet the high priority time bound requirements without any additional cost to the Bank.
- c) Bidder to ensure that the Original Equipment Manufacturer (OEM) Engineer to run all test cases as applicable to the OEM's Native ATM Application Software in the Multi-Vendor Software (MVS) environment and certify that the results in MVS environment is same as in OEM's Native



ATM Application software. The discrepancies observed, if any, should be communicated to the Bank and the necessary fixes / patches to be developed and deployed within the stipulated timeline advised by the Bank. Any financial loss suffered by the Bank due to non-resolution of these discrepancies will be borne by the bidder. The decision of the Bank in this regard will be binding on the bidder. The Bank reserves the discretion to waive off the financial loss amount.

- d) The bidder should arrange for any customization required in the ATM Application software / XFS layer / proprietary drivers etc. as and when required by the Bank for supporting the Bank's MVS, without any cost to the Bank.
- e) Bidder to close all security observations raised by Information Security Department before pilot.
- f) Bidder to ensure that the developed ATM application(s) are PA-DSS certified.
- g) Bidder to ensure that the EMV Kernel(s) provided are EMVCo certified.
- h) Bidder to conduct functionality tests to avoid any operational level issues.
- i) Bidder to get sign off post completion of functionality tests with Bank.
- j) If the machines supplied for services by the successful bidder(s) are incompatible with the Bank's existing MVS, EPS, other software, and despite developments / customizations / modifications by the OEMs, machines not become compatible within reasonable time (as deemed fit by bank), the Bank can disqualify the successful bidder(s) as per its sole discretion.

### **1.2 Electronic Journal (EJ):**

- a) Bidder shall be responsible for terminal availability to enable EJ pulling by the ATM Applicant (MVS) Vendor. The responsibility of EJ pulling is of MVS vendor however, Bidder shall provide support to MVS team for EJ pulling and coordinate with them on regular basis.
- b) In case of settlement of any claim of the Cardholder by the Bank in the event of non-availability of EJ due to fault of the vendor(s), the Bank reserves the right to recover the amount of transaction claim, alongwith award / penalty / losses if any, from the Vendor. Banks' decision in this regard is final and binding to vendor(s).
- c) The following penalties shall be applicable for non-performance / delayed performance of EJ related activities due to fault of the vendor(s). Banks'

decision in this regard is final and binding to vendor(s). Bank shall levy a penalty of ~~Rs. 1,000/-~~ ₹500/- per ~~instance transaction~~ in case of:

- (i) Faults in the machine cases not resolved within T+1 days.
- (ii) In case EJ data is not complete or unavailable at endpoint itself, penalty shall be charged for actual amount of claim received with penalty amount paid by Bank to the claimant (if any), for which bank is liable to make good the claim, on account of non-submission of EJ. It is the responsibility of the bidder to provide the EJ and make EJ available in the machine. Apart from it, if any losses occur to Bank due to incomplete or non-availability of eJ in the machine, the loss amounts shall be paid by Vendor.
- (iii) It is desirable that necessary agreements are in place between the respective vendor stakeholders (between TOM vendor, Hardware OEM, Software vendor, Network SP) for field operational issues and necessary SOP may be prepared by the TOM vendor in documenting the roles and responsibilities of the respective stakeholders to avoid any dispute amongst vendor stakeholders in providing services to the Bank.
- (iv) Bank shall not be a party in such disputes, and it will be the responsibility of the successful bidder (i.e., TOM vendors) for resolution of any transaction / EJ dispute and accountable for penalty if any in any event of non-availability or incomplete EJ / required logs due / Network / Hardware or any other issue or award / court order.

### **1.3 Provision of DVSS Images / Footages:**

- a) DVSS images / footages include the captured images / footages from the Top Hood camera as well as the cash-slot cameras and any other cameras installed within the machine.
- b) ~~Endpoint Provider shall arrange to store DVSS footages up to a period of 180 days. DVSS images backup and EJ Backup as and when required by the Bank and during preventive maintenance shall be done by the Vendor without any additional cost to the Bank. Bidder shall be responsible for availability of all cameras in working condition 24x7x365 as well as sufficient store space in HDD for storage for minimum 180 days. The responsibility of DVSS footages retrieving is of MVS vendor however, Bidder shall provide support to MVS team for retrieving of DVSS footage(s) and coordinate with them on regular basis.~~

- c) If the vendor fails to provide the DVSS footage within 1 day when required by the Bank (within 180 days of the incident), for any reason including settlement of complaints within a reasonable time, the vendor will be liable to pay a penalty of Rs. ~~1,000/=~~ 500/= per ~~instance transaction~~ or the amount of ~~award~~ / penalty / loss suffered by the Bank on account of non-availability of such DVSS footage, whichever is higher.

## **2. NETWORKING / CONNECTIVITY OF ATMS:**

### **2.1 Switching:**

The Endpoints have to be interfaced with Bank's BASE 24 switch. However, the Bank reserves the right to change the switching interface at any point of time. In such cases it will be binding upon the selected Bidder to provide the required support to commission the Endpoints with new switching interface without any additional cost to the Bank.

### **2.2 Offsite Endpoints:**

- a) Networking / Connectivity shall be provided by successful bidder, at all Offsite endpoints (installed by bidder under this RFP) and should be networked, monitored and managed by the vendor.
- b) ATM Switch hosted at participating Banks' Data Centre and DR locations.
- c) The Vendor should provide Integrated Dual Modes of connectivity for each ATM with Primary and Secondary mode of connectivity. The Switchover from Primary to Secondary and vice-verse should be automatic such that no connectivity disruption occurs. Dual Mode connectivity means: -
- i. Combination of any 2 different modes like Dual 4G / 5G SIM (Primary) with auto switch over between the 2 SIMs + VSAT (secondary) OR Broadband (primary) + Dual 4G / 5G SIM (Secondary) with auto switch over between the 2 SIMs OR any other combinations. Dual 4G / 5G SIM connectivity should be provided from two different services providers. **Dual 4G / 5G links should be on Active-Active with auto switchover to ensure seamless auto switchover amongst the two 4G / 5G links of the two separate Telcos / Service providers.**
  - ii. Wherever (i) is not feasible and only single mode option like only VSAT is available at a location, then ~~combination of 2 different service providers like Hughes VSAT (primary) + Tata Nelco VSAT (secondary) etc. with auto switchover facility between the two~~ one VSAT in extended C Band shall be provided by Vendor.

- d) Vendor and / or its sub-contractor(s) shall maintain dashboard(s) for connectivity monitoring and for Complaint Management System and Vendor and / or its sub-contractor(s) shall provide access of dashboard(s) to the Bank officials at various levels.
- e) The vendor should provide reliable and uninterrupted connectivity for ATMs. Using any of the last mile like leased line Fiber / Copper, RF, UBR, Dual 4G / 5G SIM {Dual 4G / 5G SIM connectivity should be provided from two different services providers}, VSAT or any upcoming newer technologies will also be acceptable subject to the clearance from Bank's Information Security Department (if not already done). Preference to Dual 4G / 5G SIM based connectivity or optical fibre may be given over VSAT. VSATs should be installed only at locations where Dual 4G / 5G SIM based connectivity is not available. Dual 4G / 5G SIM based connectivity should be capable of providing multi-SIM connectivity which shall be delivered as per the Bank's requirement.
- f) ~~The minimum bandwidth in case of VSAT last mile at each location for each ATM should be dedicated 64 Kbps with 100% concurrency (demand as on today) in extended C Band. Per ATM bandwidth requirement should match with the day-to-day requirement.~~ Minimum bandwidth in case of VSAT last mile at each location for each ATM should be dedicated 32 Kbps for upload & download respectively with 100% concurrency (demand as on today). Further, if two or more ATMs are connected with same VSAT then bandwidth would be 64 kbps using (Number of ATMs x Bandwidth) formula. However, this is applicable for VSAT connectivity only. The dedicated bandwidth should be adequately provided to carry out transactions smoothly.
- g) Any software or application upgradation or network security requirements or application demands the bandwidth upgradation, the same should be made adequately available at no additional cost to the Bank to cater to the day-to-day requirement within the contract period. The same is applicable for other last mile also.
- h) Bidder should also arrange for backhaul (from service providers BSNL, Bharti Airtel, Vodafone, TCL, Reliance JIO, Sify, Hughes, Tatanet, Railtel etc.) and other communication devices at bank PR and DR site and also ensure ATMs to Bank's Servers connectivity. Currently ATMs are communicating with five types of Bank's servers i.e ATM Switch, MVS / EPS, DNS, EJ and ATM-ESQ, which may change as per Bank's requirement. Leased circuits for backhaul links shall not be shared with any other entity. Bidder should provide connection between the Services Centre and ATM switch with high level

security standards like network connectivity through IPSEC / 3DES dedicated servers located at Bidder's end to remotely run special commands, firewall / De Militarized zone (DMZ) and other IP security methods.

- i) The backhaul link each between Networks service provider's Hub / NOC, to Banks' Data Centres and Disaster Recovery Centres should be configured with end-to-end IP Sec should support AES, GCM, SHA2 or any latest encryption which Bank may ask as per requirement during the contract period.
- j) Management Centre of the Bidder also need to be connected to Banks' Data Centres and Disaster Recovery Centres for monitoring purpose, if required by the Bank. The cost of leased line and back up connectivity from the Bidder's Management Centre and DR Site to the Bank's Switch and DR Site must be borne by the bidder. The recurring expenditure relating to connectivity shall be borne by bidder. Cost of licenses / software / hardware / services, etc. required to provide the Services will be borne by the bidder.
- k) A backup link of equal bandwidth to the Primary Backhaul links from a different service provider with end-to-end IP Sec / 3DES or any higher version should also be provided by the Service Provider with high availability configuration like dual hand-off / dual last mile. Vendor should ensure that backup links are properly configured as per Bank's requirement and have connectivity with two different service providers from Bank's Data centre to vendors HUB / NOC in order to provide uninterrupted connectivity services.
- l) Router, switches, cables or any network devices required should be owned and installed by the bidder at all ATM locations. The physical and logical security of these devices are responsibility of the bidder only. The maintenance and up keeping the devices is entirely on bidder only. In case of difficult areas where traveling is challenge, the bidder can manage with dual devices.
- m) The bandwidth of backhaul should be minimum of 200% capacity of the anytime peak utilization.
- n) Bidder should provide, install and maintain routers and / or other network equipment at Bank's Data Centres and Disaster Recovery Centres and at the vendor's Hub / NOC including high availability. This should be done in consultation with Banks' Networking Departments.
- o) The Vendor should allocate dedicated IP addressing scheme in co-ordination with Bank's Networking Department / System integrator of the Bank.

- p) The proposed networking plan with all technology details should be enclosed to the Technical Bid.
- q) The Vendor is required to undertake all the up gradation / installation of Operating System patches as and when required.
- r) The Vendor should ensure that their network equipment installed at Bank's DC and DRC are on dual power supply including MUX equipment from telecom service providers.
- s) If rack is required at DC / DR location the rack specification should match with SBI DC standard rack specifications.
- t) The Network should adhere to the following security aspects:
- i. Strong Authentication (authentication)
  - ii. IPsec tunnel for the traffic from ATM to Banks' Data Centres and Disaster Recovery Centres, as advised by the bank to ensure data confidentiality.
  - iii. Segregation of proposed network from other customers. If total physical segregation is not feasible, network level access controls including firewalls and router-based access control should be implemented to ensure that there is adequate logical separation between the different systems/networks at the Hub / NOC.
- u) The Bank reserves the right to conduct post-implementation audits of the Network to ensure that the security controls are in place.
- v) The Vendor should carry out necessary configuration changes in their network, if in future the Bank decides to carry out design modification and / or application modification to the Banks' ATM network, including modification for the security policy implementation. The cost of such configuration modifications should be entirely borne by the Vendor.
- w) Bidder should have clear Disaster Recovery and Business Continuity Plan and the details of the same should be furnished. Vendor should participate the mandatory IBCE / DR Drills as directed by the bank.
- x) Bidder shall carry out necessary configuration changes in their network, if in future the Bank decides to carry out design modification and/or application modification to the Banks' ATM network, including modification for the security policy implementation. The cost of such configuration modifications (including any hardware/software upgrades) shall be entirely borne by bidder. Non-compliance by bidders shall attract penalty of Rs. 5000 per day per endpoint from the end date advised by the Bank for compliance.

### **2.3 Secured Virtual Private Network:**

The Bank may, at its sole discretion, provide remote access to its information technology system to Vendor through secured Virtual Private Network (VPN) in order to facilitate the performance of Services. Such remote access to the Bank's information technology system shall be subject to the following:

- i. Vendor shall ensure that the remote access to the Bank's VPN is performed through a laptop/desktop ("Device") specially allotted for that purpose by the Vendor and not through any other private or public Device.
- ii. Vendor shall ensure that only its authorized employees/ representatives access the Device.
- iii. Vendor shall be required to get the Device hardened/configured as per the Bank's prevailing standards and policy.
- iv. Vendor and/or its employee/representative shall be required to furnish an undertaking and/or information security declaration on the Bank's prescribed format before such remote access is provided by the Bank.
- v. Vendor shall ensure that services are performed in a physically protected and secure environment which ensures confidentiality and integrity of the Bank's data and artefacts, including but not limited to information (on customer, account, transactions, users, usage, staff, etc.), architecture (information, data, network, application, security, etc.), programming codes, access configurations, parameter settings, executable files, etc., which the Bank representative may inspect. Vendor should ensure that the laptop/desktop ("Device") which has access to Bank's VPN, SHOULD NOT be connected through any open-source / unsecured / public wi-fi connectivity. Vendor shall facilitate and/ or handover the Device to the Bank or its authorized representative for investigation and/or forensic audit.
- vi. Vendor shall be responsible for protecting its network and subnetworks, from which remote access to the Bank's network is performed, effectively against unauthorized access, malware, malicious code and other threats in order to ensure the Bank's information technology system is not compromised in the course of using remote access facility.

### **3. ENDPOINT MIGRATION FROM MVS + EPS TO OEMS NATIVE SOFTWARE:**

All the machines to be installed should be compatible to be running on Multi-Vendor Software Solution and Endpoint Protection Solution from day one.

**3.1** In the event of Bank deciding to switch over from Multi-Vendor Software Solution and Endpoint Protection Solution to OEM's Native application, ATM should be capable of running OEM's native ATM software and its allied applications (if any) without any hardware changes. The Endpoint Provider will be responsible for testing, integration, commissioning and coordinating implementation of OEM's Native Software in already deployed (or to be deployed) ATMs, without any extra

cost to the Bank, as per requirement(s) of the Bank. The successful bidder(s) to support all activities involved in the switch back to OEM native ATM application along with fulfilling requirements as per RFP including those mention in Appendix-C of Technical and functional specifications with Security Softwares. Security softwares include but not limited to: -Whitelisting solutions, Time based admin access, Transport Layer Security (TLS) 1.2 or higher, full Hard disk encryption, OTP based access etc. as per RBI Control Measures for Digital Security guidelines. Endpoint provider to ensure timely completion of the concerned activities during the tenure of the contract. The illustrative details have been furnished as under: -

- i. To provide end to end support for solutions integration, testing at the endpoints provided, under the testing environment and successful pilot at two live Endpoints under the production environment.
- ii. To share Single Point Contact along with Escalation matrix for Solutions Support.
- iii. To share the following details and any other details required in connection with Endpoints supplied to the Bank, with testing of all the functionalities, proper error codes, health status messages, device status messages etc at the Endpoint.
- iv. Support for Operating System
  - Windows 11 / permitted Windows 10, patches, service packs etc.
  - Changes in Operating System or its configuration (environment variable, parameter changes, enabling / disabling services etc)
  - End-user License Agreement (EULA)
  - Any other relevant information including Best Practices
- v. Hardware / software (both CEN XFS Compliant and Non-CEN XFS compliant)
  - Technical Specifications,
  - Documentations,
  - Drivers,
  - Terminal Diagnostic Tools/Utilities
  - Configuration / Parameter details,
  - Components,
  - Services
  - Patches, updates and upgrades
  - EMVCo/PCI certificates
  - Any other relevant information
  - Functional test cases (Positive and negative)
  - Error codes, Health Status Messages, Device status messages.
- vi. Provide complete details of XFS Devices (Illustrative List of XFS Devices are given as under):



- Printer and Scanners
  - Card Readers (incl. EMV Contact / Contactless)
  - Cash Dispensers
  - Personal Identification Number Keypads (PIN pads)
  - ~~Cheque Readers and Scanners~~
  - Depository Units
  - Screen Displays (including Touch Screens)
  - Vandal Shields
  - Text Terminal Units
  - Sensors and Indicators Units
  - Vendor Dependent Mode
  - Cameras
  - Card Embossing Units
  - Alarms & Sensors
  - Cash-In Modules
  - Card Dispensers
  - Barcode Readers
  - Biometric Readers
  - Item Processing Modules
- vii. Endpoint Provider to provide Full support for the NDC Application (connected to the switch) with respect to any clarifications and resolution sought regarding the platform behavior or compliance to the NDC Specifications.
- viii. Fixing of bugs / issues raised during the pre-implementation and pilot phase.
- ix. To support the functionality tests to avoid any operational level issues.
- x. Maintaining endpoint/ATM-Wise version control of Solutions with granularity.
- xi. Pilot Implementation at two Endpoints of respective models/processors and its variants at live sites identified by the Bank.
- xii. To provide support for Regulatory compliance.
- xiii. To provide sign off post completion of functionality tests.

### **3.2 Centralized Electronic Journal (EJ) Pulling:**

3.2.1 In the scenario of migration of MVS to OEMs native software, following conditions to be fulfilled by the bidder: -

- a) The ATMs deployed should be compatible with the EJ pulling software agents such as Tranxit / SDMS / Radia / InfoBase etc. and / or with any

other EJ pulling agent that may be deployed from time to time. Agent installation on ATMs as may be required from time to time will be the responsibility of the bidder / vendor and will be done free of cost i.e., without any cost to the Bank.

- b) EJ log must contain atleast the following information:
  - i. Card Entry,
  - ii. Amount Entry,
  - iii. PIN Entry,
  - iv. Request sent to Switch,
  - v. Response from Switch,
  - vi. Cash stacked status,
  - vii. ATM Transaction number,
  - viii. Switch RRN number,
  - ix. Cassette configuration details,
  - x. Switch data containing the complete transaction details from Switch end,
  - xi. Counters information for each cassette & reject bin,
  - xii. Cash presented,
  - xiii. Cash Taken/Timeout,
  - xiv. ATM messages (if any),
  - xv. EMV / Magstripe based txn.,
  - xvi. No. of pieces of currency dispensed denomination-wise after each txn.,
  - xvii. No. of pieces of currency remaining denomination-wise after each txn. in each cassette & reject bin,
- c) The Bank may add any other information in the eJ format or advise a set eJ format to be implemented by the Vendor, without any cost to the Bank.
- d) The Vendor should have the facility to extract the Electronic Journals of all the transactions in each of the ATM, to a centralized location / Server.
- e) The vendor has to provide EJ on T+1 basis for reconciliation purposes to Bank in the format desired by reconciliation software of the Bank. ("T" is the transaction date)
- f) ATM-wise EJs should be stored in the EJ server of the Vendor at a Centralized location for minimum period of 180 days. Bidder to ensure EJ pulling from the ATM at specified time as per Bank / vendor's specifications. ATM-Wise EJs pulled are to be spooled separately and pushed to the designated server on daily basis. ATM-wise EJ data should be made available for a minimum period of twelve months. The EJ data may be purged by the Bidder after seeking confirmation of the Bank, after taking necessary Backup and handing over this backup to Bank's Team.
- g) EJ pulling should be done on daily basis and sent to Banks' designated servers on T+1 basis.
- h) The Vendor should provide EJ viewer facility to the Bank.

- i) In case of settlement of any claim of the Cardholder by the Bank in the event of non-availability of EJ for the same, the Bank reserves the right to recover the amount of transaction claim, alongwith penalty / losses if any, from the Vendor.
- j) The process of extracting and sending EJ to Bank's DC.
- k) The EJ's will be pulled each day between 00:00 Hrs and 07:00 Hrs. for the previous day through automated schedules configured for daily EJ pulling at the server.
- l) The EJ's which cannot be retrieved through the automated schedules shall be retrieved and delivered to the Bank on next day before 1.00 p.m.
- m) Customer transactions will take precedence over the EJ pulling process and if a transaction occurs while EJ is being pulled the EJ process will be stopped to complete the transaction. The remaining part of the EJ will be pulled after the transaction is completed.
- n) **EJ Penalties**→ EJ Disconnected / Disputed Cases / Incomplete EJ / unavailable EJ:

The following penalties shall be applicable for non-performance / delayed performance of EJ related activities due to non-working of EJ module. Bank shall levy a penalty of Rs. ~~1,000/-~~ 500/- per ~~instance~~ transaction per day in case of:

- (v) EJ disabled and EJ disconnected cases not resolved within T+1 days.
- (vi) In case EJ data is not complete or unavailable at endpoint itself, penalty shall be charged for actual amount of claim received with penalty amount paid by Bank to the claimant (if any), for which bank is liable to make good the claim, on account of non-submission of EJ. It is the responsibility of the bidder to provide the EJ and make EJ available. Apart from it, if any losses occur to Bank due to incomplete or non-availability of eJ by Vendor, the loss amounts shall be paid by Vendor.
- (vii) It is desirable that necessary agreements are in place between the respective vendor stakeholders (between TOM vendor, Hardware OEM, Software vendor, Network SP) for field operational issues and necessary SOP may be prepared by the TOM vendor in documenting the roles and responsibilities of the respective stakeholders to avoid any dispute amongst vendor stakeholders in providing services to the Bank.
- (viii) Bank shall not be a party in such disputes, and it will be the responsibility of the successful bidder / Service provider (i.e., TOM

vendors) for resolution of any transaction / EJ dispute and accountable for penalty if any in any event of non-availability or incomplete EJ / required logs due to MVS / Network / Hardware or any other issue.

### **3.3 Content Management / Software Distribution**

- a) Vendor should provide Software and Screen distribution from central location to different Endpoints rolled out under the tender to facilitate individual configuration and screen displays.
- b) Facility for remote loading of Endpoints screens and Software distribution should be available including provision of software for such facilities and the activity should be carried out by the bidder / vendor free of cost. The Bank will not provide any software / agent for the same nor pay for these agents separately.
- c) The Endpoints screen will only be used for display of publicity material approved by the Bank and bidder shall arrange for that. Bidder CAN NOT display any content on the Endpoint screen without Bank's Approval.
- d) The screen distribution should be platform independent – should support Windows 11 / permitted Windows-10 operating systems normally installed on Banks ATMs.
- e) The system adopted should be capable of distributing screens at ATMs running on the network connectivity provided by the bidder in this RFP.
- f) The solution should support PCX, GIF, MPEG, FLC, FLI and other audio / video file formats.
- g) The solution should be capable of centralized distribution of screen at scheduled and ad hoc basis.
- h) The solution should be capable of centralized distribution of software upgrades and patches to the ATM.
- i) The solution should be capable of centralized distribution of antivirus patches to the ATM.
- j) The solution should be capable of distributing screens at specified number of ATM.
- k) The solution should be capable of performing rollback if the ATM needs to be brought to the previous state.
- l) All necessary hardware / software etc. shall be provided by the bidder for screen distribution.

- m) The connectivity with back up arrangement between the managed centre of the bidder and Bank's Data Centre and DR Site shall be provided by the Bidder at no extra cost to the Bank.
- n) The bidder shall provide the MIS / Reports confirming the download.

### 3.4 Provision of DVSS Images / Footages

- d) DVSS images / footages include the captured images / footages from the Top Hood camera as well as the cash-slot cameras and any other cameras installed within the machine.
- e) ~~Endpoint Provider shall arrange to store DVSS footages up to a period of 180 days. DVSS images backup and EJ Backup as and when required by the Bank and during preventive maintenance shall be done by the Vendor without any additional cost to the Bank. Bidder shall be responsible for availability of all cameras in working condition 24x7x365 as well as sufficient store space in HDD for storage for minimum 180 days. The responsibility of DVSS footages retrieving is of MVS vendor however, Bidder shall provide support to MVS team for retrieving of DVSS footage(s) and coordinate with them on regular basis.~~
- f) If the vendor fails to provide the DVSS footage within 1 day when required by the Bank (within 180 days of the incident), for any reason including settlement of complaints within a reasonable time, the vendor will be liable to pay a penalty of Rs. ~~1,000/=~~ 500/- per ~~instance~~ transaction or the amount of penalty / loss suffered by the Bank on account of non-availability of such DVSS footage, whichever is higher.

## 4. PRE-IMPLEMENTATION AND POST-IMPLEMENTATION SERVICES

The successful bidders will provide a complete 360 degree external and internal 3D representation of the proposed ATM site with back room, and the ATM Machines with all allied equipment, external signage, entry door, placement of notice boards etc. (as per the SIS scope mentioned in this RFP) to the Bank. This will help in basic visualization and common understanding of the deliverables. The changes, if required, will be discussed, and will be mutually agreed between the parties. The bidders should implement (at each site) as per the agreed 3D representation. Bank understands that each site is different, and some items may not be implementable due to constraints, but the basic visualization agreed in the 3D representation should be implemented.

**The pre and post implementation services include:**

- 4.1 Site Implementation Services (SIS),
- 4.2 e-Surveillance Systems Services (eSS),

- 4.3 Site Maintenance,
- 4.4 Housekeeping Services (Optional in nature),
- 4.5 Managed Services inclusive of Cash Replenishment Services,

#### 4.1 Site Implementation Services (SIS)

- a) Bidder shall conduct site identification exercise and offer suitable site in the vicinity of locations desired by the Bank. Vendor cannot refuse installation of Endpoints at the site desired by the Bank. In case of refusal or non-installation of Endpoint at the site desired by the Bank within 30 days of issuance of PO, a penalty equal to Rs. ~~5,000~~1,000/- per day will be charged to the vendor.
- b) There can be instances wherein the Bidders are assigned their old / existing sites which were under Bank's earlier MOF / TOM Agreements. At all such sites, the bidders should ~~renovate / modify~~ refurbished / renew them as per the approved 3D representation of sites.

Alternatively, there can be instances wherein the Bidders are assigned sites of other vendors which were under Bank's earlier MOF / TOM Agreements. At all such sites, the bidders should co-ordinate with the earlier vendors for site rental assignments to them & other formalities required for the takeover from earlier vendors. New Bidders should ~~renovate / modify refurbishment /~~ renew the sites as per the approved 3D representation of sites.

c) **Offsite locations:**

Bidder should refer site specifications. Additionally, Bidder would be responsible for the following:

- i. The site should be at the ground floor and on the main roads at the prominent locations like corporate outlets, marketplaces, malls, etc.
- ii. The area of site shall be atleast 70 - 100 sq ft. suitable for installation of endpoint.
- iii. Site should be accessible round the clock. However, exceptions would be made in case of certain establishments where public access is prohibited after certain time only with prior permission of the Bank.
- iv. ~~Ramps should be provided at all sites~~ All ATM sites should be equipped with RAMP facility as per regulatory guidelines. Vendor should fulfil all existing and time to time issued government / statutory

guidelines in this regard. ~~If RAMP is not feasible at the existing site, the ATM lobby should be shifted to a site with RAMP, after Bank's approval.~~

- v. Bank will indicate broad area of the centre, name of District, etc.
- vi. The Vendor will, however, seek confirmation about the Bank's link branch for Cash Replenishment which, in normal course, will be advised within one week by the Bank.
- vii. The site should be feasible for the connectivity requirements of ATMs. The connectivity requirements to support the e-Surveillance Systems should also be feasible at the site.
- viii. The Vendor should arrange for lease agreement / ownership for the site, roof rights in case of VSAT installation / solar panel installation where endpoint are installed / proposed to be installed.
- ix. Vendor is responsible for timely payment of Rent, electricity bills, all applicable taxes, lease deed expenses and any other expenses or any dispute arising regarding such items.
- x. Vendor shall obtain all statutory approvals from the landlords and municipal and concerned authorities.
- xi. Installation and maintenance of UPS with minimum 8 hours fast charging SMF / Lithium-ion battery backup. At locations where electricity availability is erratic, battery backup should be minimum 8 hours or adequate backups. However, it is responsibility of the Vendor to arrange for uninterrupted power supply for ATM functioning. In areas where there is load shedding, the Vendor should arrange for alternate Power supply arrangements like DG set, solar power, etc.
- xii. Bank's prior approval is required to be obtained, in case the Vendor desires to relocate any of the endpoint for reasons other than request from the Bank at own cost.
- xiii. Any licenses / authorizations required for installation of endpoint at selected site shall be arranged by Vendor in the name of the Bank.
- xiv. Selected Vendor will not install its White Label ATM(s) / ADWM(s) / White Label Mobile ATM / White Label Mobile ADWM within vicinity of ~~500~~ 1,000 metre of SBI ATM / ADWM. Bidder shall immediately inform

the Bank, if White Label ATM(s) / ADWM(s) / White Label Mobile ATM / White Label Mobile ADWM is / are running within the proximity of 1,000 metre of SBI ATM / ADWM.

- xv. Installation of two new Air Conditioners (AC) as per specifications. Stabilizers, timers, Copper piping, drain-pipe, Caging for Outer Units.
- xvi. The vendor must ensure ambient environment for the machines.

#### **4.1.1 Site Work Specifications – General guidelines: -**

- i. All electrical points, switches, cables / wires should be hidden / concealed from the public.
- ii. Implementation of External Digital Signage Solution as per bank requirement as and when demanded (site shall be as per bank discretion) along with its maintenance. In case, Bank desires for static External Backlit SBI Logo Signage, the same should be provided at no additional cost to the Bank.
- iii. SBI “ATM” refers to a site with single type of ATM machine which only dispenses cash whereas SBI “e-Corner” refers to site with multiple types of machines like ATM, ADWM, Swayam, Coin Vending Machine, Cheque Deposit Machine etc.
- iv. The external signage must be in English for all States Except Karnataka. The signage script of the regional language to be obtained from the Local Head Office. For External Digital Signage Solution, Bank shall provide the digital content to be displayed from time to time and Vendor should coordinate with Bank and arrange for the same.
- v. There shall be a rolling shutter for each site.
- vi. For any ATM room renovation, the respective sub-Vendors like, OEM Vendor, Communication Vendor, e-Surveillance vendor, CRAs etc. should be contacted for reinstallation of various components.
- vii. All major components like UPS, air-conditioners, electrical items including cables, wiring, switches etc. shall bear ISI certification (or made by ISO certified company). All major items like UPS and air conditioners are to be procured only from reputed Brands with all India service support. Brand names given for UPS, ACs or other items are illustrative only and not exhaustive.



- viii. All Open Files for Artwork / Signages will be available from Local Head Offices, if required. In case, if the same are unavailable, Vendors can create them based on the creatives / posters shown in this document.
- ix. ~~Ramps should be mandatorily available~~ All ATM sites should be equipped with RAMP facility as per regulatory guidelines. RAMPs with stainless Steel railings should be made for disabled customers to reach the ATM room easily.
- x. BI-LINGUAL creatives to be used in States where Hindi is prominently used.
- xi. TRI-LINGUAL creatives to be used in States where a third regional language is prominently used.
- xii. All ATM Room should have provisions of a small back room to keep the peripherals like UPS & Batteries, Communication Equipment, e-Surveillance panel, CCTV DVR, all power switches etc. There must be a false wall separating the back and front rooms. All Machines should be placed through this false wall such that only the front portion is accessible to customers and the rear portion with external cables are in back room. A lockable door should be present for access the back room. Public should not access the back room. Refer the images below: -



t &  
ent

**Machine through a false wall**

Picture 1 ATM in False wall



Picture 2 ATM in False wall

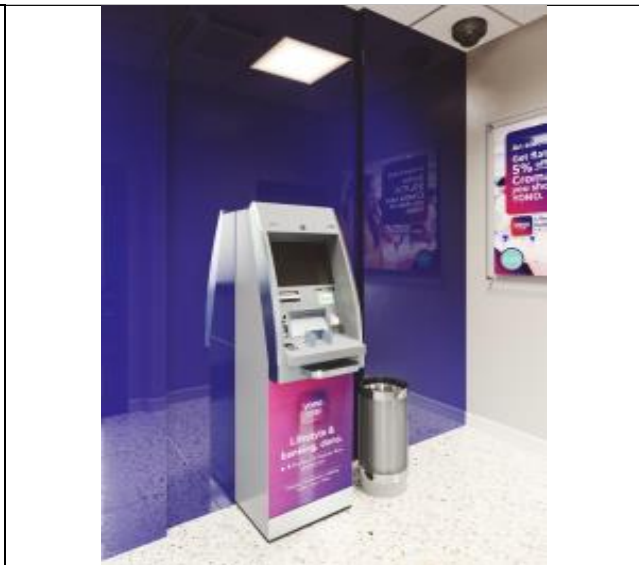
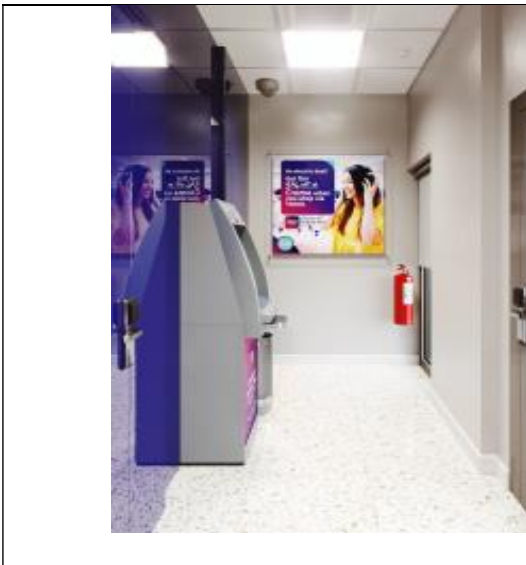

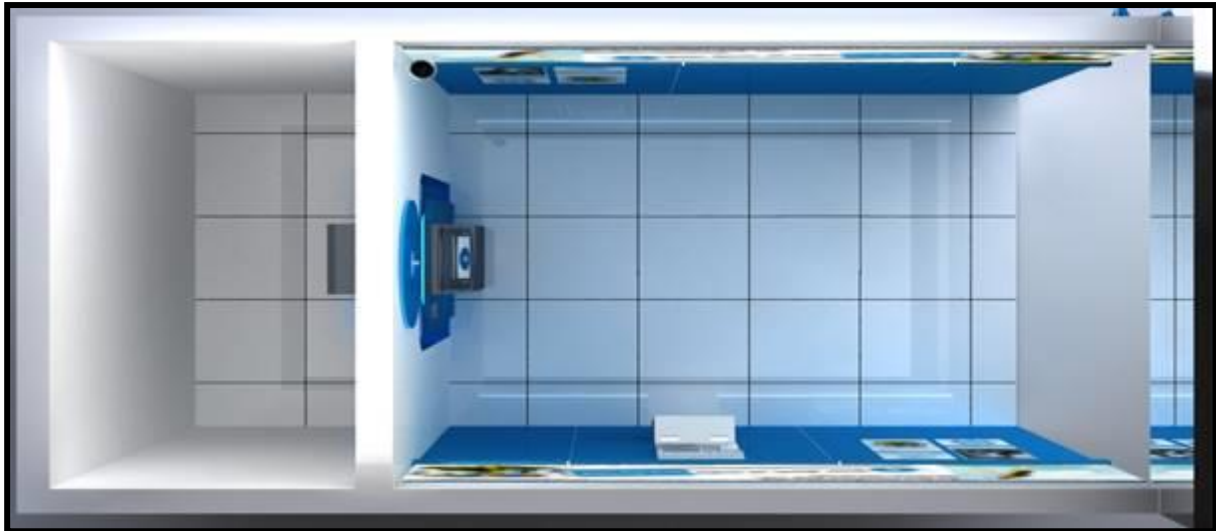

For e-Corner with Multiple Type of machines: -



Uniform façade: The ATM Room shall have full glass door entrance and other non-entry glass panes. Depending on the site size, there can be multiple non-entry glass panes. On each glass pane, generic see-through sticker films are to be pasted.

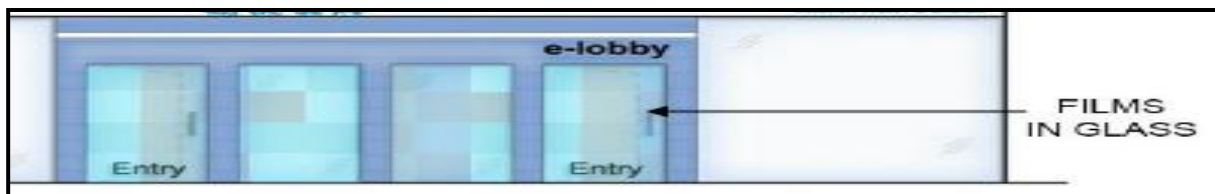



The following artwork to be shown on non-entry glass panes

No. of Non-Entry Glass Panes	Artwork			
1				
2				
3				
4				
5				



Each Entry Door will have the following see-through artwork based on the location (Metro or Non-metro), as under:

**Metro Centres** (Mumbai, Delhi, Kolkata, Chennai, Bangalore, Hyderabad)

**NON-Metro Centres** (other than Metro centres mentions in leftside)

BILINGUAL

## मेट्रो एटीएम METRO ATM

यहाँ पर सभी बैंकों के कार्ड्स स्वीकार किए जाते हैं  
CARDS OF ALL THE BANKS ARE ACCEPTED HERE



यहां डायनामिक करेंसी कन्वर्शन (DCC) सुविधा उपलब्ध है  
Dynamic Currency Conversion (DCC) Facility available here

X एटीएम रूम में निषिद्ध / Prohibited in ATM Room X



चेहरा ढँकना  
Covered face



हेलमेट पहनना  
Wearing Helmet



फोन कॉल्स  
Phone Calls



सनग्लासेस  
Sunglasses

एक बार में केवल एक व्यक्ति / Only One Person at a Time

Size: 12(w) x 24(h) inch

## नॉन-मेट्रो एटीएम NON METRO ATM

यहाँ पर सभी बैंकों के कार्ड्स स्वीकार किए जाते हैं  
CARDS OF ALL THE BANKS ARE ACCEPTED HERE



यहां डायनामिक करेंसी कन्वर्शन (DCC) सुविधा उपलब्ध है  
Dynamic Currency Conversion (DCC) Facility available here

X एटीएम रूम में निषिद्ध / Prohibited in ATM Room X



चेहरा ढँकना  
Covered face



हेलमेट पहनना  
Wearing Helmet



फोन कॉल्स  
Phone Calls



सनग्लासेस  
Sunglasses

एक बार में केवल एक व्यक्ति / Only One Person at a Time

Size: 12(w) x 24(h) inch

**Metro Centres** (Mumbai, Delhi, Kolkata, Chennai, Bangalore, Hyderabad)

**NON-Metro Centres** (other than Metro centres mentions in leftside)

TRILINGUAL (RESPECTIVE REGIONAL LANGUAGE)

## മെട്രോ എടിഎം मेट्रो एटीएम METRO ATM

എല്ലാ ബാങ്കുകളുടെയും കാർഡുകൾ ഇവിടെ സ്വീകരിക്കപ്പെടുന്നു  
यहाँ पर सभी बैंकों के कार्ड्स स्वीकार किए जाते हैं  
CARDS OF ALL THE BANKS ARE ACCEPTED HERE



ഡൈനാമിക് കറൻസി കൺവർഷൻ (DCC) ഫെസിലിറ്റി ഇവിടെ ലഭ്യമാണ്  
यहाँ डायनामिक करेंसी कन्वर्शन (DCC) सुविधा उपलब्ध है  
Dynamic Currency Conversion (DCC) Facility available here

എടിഎം മുറിയിൽ ഇവ നിരോധിച്ചിരിക്കുന്നു  
एटीएम रूम में निषिद्ध / Prohibited in ATM Room



മുഖം മൂടൽ  
चेहरा ढँकना  
Covered face



ഹെൽമെറ്റ് ധരിക്കൽ  
हेलमेट पहनना  
Wearing Helmet



ഫോൺ കോളുകൾ  
फोन कॉल  
Phone Calls



സൺഗ്ലാസ്സുകൾ  
सनलसेस  
Sunglasses

ഒരു സമയത്ത് ഒരാൾ മാത്രം  
एक बार में केवल एक व्यक्ति / Only One Person at a Time

Size: 12(w) x 24(h) inch

## നോൺ-മെട്രോ എടിഎം नॉन-मेट्रो एटीएम NON METRO ATM

എല്ലാ ബാങ്കുകളുടെയും കാർഡുകൾ ഇവിടെ സ്വീകരിക്കപ്പെടുന്നു  
यहाँ पर सभी बैंकों के कार्ड्स स्वीकार किए जाते हैं  
CARDS OF ALL THE BANKS ARE ACCEPTED HERE



ഡൈനാമിക് കറൻസി കൺവർഷൻ (DCC) ഫെസിലിറ്റി ഇവിടെ ലഭ്യമാണ്  
यहाँ डायनामिक करेंसी कन्वर्शन (DCC) सुविधा उपलब्ध है  
Dynamic Currency Conversion (DCC) Facility available here

എടിഎം മുറിയിൽ ഇവ നിരോധിച്ചിരിക്കുന്നു  
एटीएम रूम में निषिद्ध / Prohibited in ATM Room



മുഖം മൂടൽ  
चेहरा ढँकना  
Covered face



ഹെൽമെറ്റ് ധരിക്കൽ  
हेलमेट पहनना  
Wearing Helmet



ഫോൺ കോളുകൾ  
फोन कॉल  
Phone Calls





സൺഗ്ലാസ്സുകൾ  
सनलसेस  
Sunglasses

ഒരു സമയത്ത് ഒരാൾ മാത്രം  
एक बार में केवल एक व्यक्ति / Only One Person at a Time

Size: 12(w) x 24(h) inch

#### 4.1.2 Site Work Specifications

Bidder would be responsible for Site preparation and electric work as per the following specifications:

Item Description				
<b>1. FLOORING</b>				
(a) Room Flooring				
Description	Make			
Double charges nano-polish vitrified tile flooring of size 800 X 800 mm / 800 X 1200 mm, Anti-skid, AS PER DSR 11.41.2/ 11.49.2 (8-10 mm thick) Colour – Ivory, White Base	Simpolo, Somany, Nitco, Johnson or equivalent			
(b) Flooring of external steps				
Providing and laying machine cut flame finished Granite stone flooring in required design and patterns, in linear as well as curvilinear portions of the building, all complete, with 18mm thick stone slab over 20 mm (average) thick base of cement mortar 1:4 (1 cement : 4 coarse sand), laid and jointed with cement slurry and pointing with white cement slurry admixed with pigment of matching shade, including rubbing, curing, nosing, making grooves and polishing etc. all complete as specified and as directed by the Engineer-in-Charge. (Location: steps)				
<b>2. FALSE CEILING</b>				
Description	Make			
(a) It should be capable of installing LED Panel Lights, CCTV Cameras, Smoke detectors etc.	Armstrong OPTRA FG, Hunter Douglas or equivalent as per availability.			
(b) Mineral Fibre Acoustical Suspended Ceiling, Micro look edge tiles of size 600 X 600 X 15mm thick, AS PER DSR 12.53.				
<table border="0" style="width: 100%;"> <tr> <td style="width: 40%;"><b>MINIRAL FIBRE CEILING</b></td> <td style="width: 20%; text-align: center;">  </td> <td style="width: 40%; text-align: right;"><b>Ceiling</b></td> </tr> </table>		<b>MINIRAL FIBRE CEILING</b>		<b>Ceiling</b>
<b>MINIRAL FIBRE CEILING</b>		<b>Ceiling</b>		
<b>3. PLASTIC PAINT:</b>				
<ul style="list-style-type: none"> <li>Providing and finishing walls with Acrylic Emulsion paint of approved make (Asian / Nerolac / ICI / Berger or equivalent make) and using Primer completely as per</li> </ul>				



manufacturers specification on plastered surfaces including preparing the surface, finishing and necessary scaffolding etc. The paints shall be of zero VOC (Volatile Organic Compounds) level.

- Two or more coats applied on walls @ 1.25 ltr/10 sqm over and including one coat of Special primer applied @ 0.75 ltr /10 sqm

#### 4. FIXED GLAZING

Providing and fixing external fixed glazing comprising of 10 mm Modifloat, Saint Gobain, Asahi make clear glass covered with 100 mm x 50 mm aluminium sections and clip with ..... colour mat finish powder coated (need transparent froster film on glass).

#### 5. ENTRANCE DOOR

Description	Make
12mm thick toughened glass partition and door	Saint Gobain, Asahi Float, Modi Guard or equivalent as per availability.
Aluminium Powder Coated Extruded Section	Jindal, Hindalco or equivalent as per availability.
Patch Fitting & Floor Spring	Dorma, Godrej, Ozone or equivalent as per availability.
Handle – SS 304 and 600 mm long	Haffle, Hettich, Godrej or equivalent.
Self-Sticking Polyvinyl film – Artwork	3M, Avery Dennison or equivalent.

The width of the door should be enough to allow wheelchair accessibility into the room. Providing and fixing frameless fully glazed 12mm thick toughened float glass door fixed with necessary patch fittings (Dorma / Ozone / Godrej make **or equivalent make**) including cutting, making holes, cut-outs in the glass of required shape and size to accommodate fittings and fixing the fittings in floors, soffits, jams including necessary fixtures, screws, sealant wherever required and SS cover over patch fittings. Include necessary etching film / LOGO, patch fitting locking systems, 1 pair of 600mm long S. S. (SS304) Handles of approved make, floor springs, and any necessary hardware items.(DORMA / OZONE / GODREJ MAKE **or equivalent make** Top Pivot - PT 24, Top Patch Fittings - PT 20, Bottom Patch fittings - PT 10, Floor Spring - BTS 75 V, Corner lock with strike plate and Euro Profile Cylinder - US 10, Handle - TG 9300 EQ - S 25mm dia X 300mm length)

Multiple machines site can have multiple doors or single door, as the case be (Single door preferred). There should be glass partition between each machine.

#### 6. INNER WALL COLOURS - ACP PANELLING

Description	Make
3 mm Thick Fire-Resistant Interior Grade Aluminium Composite Panel (ACP)	Alucbond, Alstrong or equivalent as per availability.

Side Panelling	Sunrise Silver Metallic 600 of Alucobond or equivalent from Alstrong
Back Wall / False wall Panelling	Ink Blue {L481-105899 / RGB: 40 0 113 / HEX: #280071 / CMYK: 97 100 0 25} of Alucobond, <del>or equivalent from</del> Alstrong <del>or equivalent.</del>

### 7. GLASS DIVIDER BETWEEN MACHINES

Description	Make
12 mm thick Toughened Glass of size 4' X 6'	Saint Gobain, Asahi Float, Modi Guard or equivalent as per availability.
Artwork	

### 8. GROUTING

- Moving / tilting of endpoint for removing existing leveling screws.
- Drilling 10" – 12" holes in the existing flooring using concrete drill bits.
- Hammering metal sleeves in these holes.
- Repositioning the ATMs over the existing markings.
- Putting in Anchor fasteners - min. 6" long anchor fasteners, preferably of Fischer make.
- Applying resin adhesive (Araldite) over the finished bolt positions for improved bonding & repairing broken tiles, if any".

### 9. ROLLING SHUTTER

- Stutters should be installed at all ATM Sites.
- Should have the capability for **motorized** functioning of rolling up & down
- Display ATM timings at entrance. Nearest ATMs address to be displayed at entrance.
- Shutter should be lockable in 3 positions: -
  - when rolled down completely,
  - rolled up completely and
  - when rolled up in half.

Description	Make
Shutter material specification AS PER DSR 10.6.1	galvanised steel or heavy-gauge aluminium; hand operated or gear operated or automated up/down through electronic motor. Lockable when rolled up and down and in middle.
Base Colour for shutter: - <b>INKY BLUE → RGB: R40 G0 B113;</b>	

Providing and applying three coats of 1st quality enamel paint including scraping the surface clean.

Artwork on Shutter: **SBI LOGO**



## 10. RAMP FOR DISABLED

(a) **ALL SITES MUST HAVE RAMPs.**

(b) Ramps with rust proof stainless steel railings should be available for disabled public to reach the ATM Room easily.

(c) The ramps should be serrated so that the wheelchairs don't slide backwards (Detailed specifications of RAMP in Appendix-Q)

Description	
Material of ramp	Concrete
	
Minimum width of the ramp	To easily accommodate a wheelchair
1:12 slope to be provided for ramp	

### Marketing Creatives / Posters

- Will be provided by Bank which should be fixed on the side walls in an acrylic sandwich sheet board for posters. Example of Acrylic poster frame:

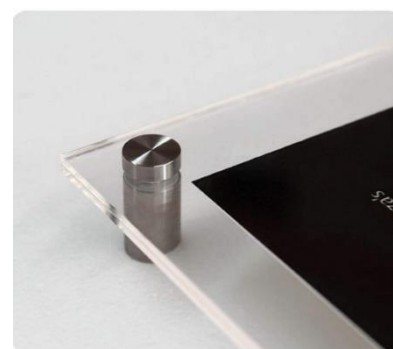

## 11.SAFETY TIPS POSTER

Bilingual/Trilingual safety tips poster should be in every ATM room.

Bilingual Poster Example:



# पहले सुरक्षा SAFETY FIRST



### एटीएम में सुरक्षा संबंधी इन सावधानियों का पालन करें FOLLOW THESE SAFETY TIPS AT AN ATM

 <p><b>अजनबी से खतरा STRANGER DANGER</b> अजनबियों से सावधान रहें Beware of strangers</p>	 <p><b>सतर्कता दिखाएं /INSPECT FIRST</b> ध्यान से देख कि एटीएम पर किसी संदेहजनक चीज तो नहीं लगी है /Look for suspicious devices attached to ATMs</p>
 <p><b>पिन / PIN</b> अपना पिन दर्ज करते समय किसी को न देखने दें Do not let anybody see you enter your PIN अपनी जन्म तिथि/वाहन नंबर आदि का पिन के रूप में इस्तेमाल न करें /Do not use Birth year / Vehicle number etc. as PIN</p>	 <p><b>ध्यान दें / LOOK AGAINST</b> ट्रांजेक्शन पूरा हो जाने पर एटीएम स्क्रीन पर फिर से स्वागत संदेश उभर आता है/Ensure Welcome Screen is displayed on ATM screen, once transactions is complete</p>
 <p><b>अपना पिन याद कर लें MEMORIZE YOUR PIN</b> अपने कार्ड पर अपना पिन लिख कर न रखें Do not write your PIN on your Card</p>	 <p><b>कैश न होने की पुष्टि करें/CONFIRM CASH OUT</b> अगर एटीएम कैश निकाले बिना 'कैश प्राप्त करें' का निर्देश देता है तो लॉबी में दिए गए हेल्पलाइन को कॉल करें Call the helpline mentioned in the lobby, when ATM instructs you to 'collect cash' without dispensing it</p>
 <p><b>प्रकट करना DISCLOSURE</b> अपना पिन नंबर किसी को न बताएं Don't share your ATM PIN with anyone</p>	 <p><b>SMS अलर्ट/SMS ALERT</b> अपने मोबाइल नंबर को ट्रांजेक्शन अलर्ट्स प्राप्त करने के लिए रजिस्टर करें/Register your mobile number to receive transaction alerts</p>

कॉल करें /CALL 18004253800, 1800112211/ टोल फ्री /TOLL-FREE 09449112211  
विजिट करें / Visit : bank.sbi | हमें यहां फॉलो करें / Follow us on 

Size: 15(w) x 20(h) inch



Trilingual Poster Example:



**ആദ്യം സുരക്ഷാ**  
**पहले सुरक्षा**  
**SAFETY FIRST**



**എടിഎമ്മിൽ താഴെപ്പറയുന്ന സുരക്ഷാ നടപടികൾ പാലിക്കുക**  
**एटीएम में सुरक्षा संबंधी इन सावधानियों का पालन करें / FOLLOW THESE SAFETY TIPS AT AN ATM**

<div style="margin-bottom: 10px;">  <p><b>അപരിചിതരെന്ന അപകടം</b> <b>अजनबी से खतरा / STRANGER DANGER</b> അപരിചിതരെ സൂക്ഷിക്കുക / अजनबियों से सावधान रहें Beware of strangers</p> </div> <div style="margin-bottom: 10px;">  <p><b>പിൻ / പിൻ / PIN</b> നിങ്ങളുടെ പിൻ അർത്ഥനാശ്ചര്യമാണ് മറ്റാരും കാണാൻ അനുവദിക്കരുത് अपना पिन दर्ज करते समय किसी को न देखने दें Do not let anybody see you enter your PIN ജനന വർഷം/വാഹന നമ്പർ മുതലായവ പിൻ നമ്പരായി ഉപയോഗിക്കരുത് अपनी जन्म तिथि/वाहन नंबर आदि का पिन के रूप में इस्तेमाल न करें Do not use Birth year / Vehicle number etc as PIN</p> </div> <div style="margin-bottom: 10px;">  <p><b>നിങ്ങളുടെ പിൻ ഹൃദിസ്ഥമാക്കുക</b> <b>अपना पिन याद कर लें / MEMORIZE YOUR PIN</b> നിങ്ങളുടെ കാർഡിന്മേൽ നിങ്ങളുടെ പിൻ എഴുതരുത് अपने कार्ड पर अपना पिन लिख कर न रहें Do not write your PIN on your Card</p> </div> <div style="margin-bottom: 10px;">  <p><b>വെളിപ്പെടുത്തൽ / പ്രകടം / DISCLOSURE</b> നിങ്ങളുടെ പിൻ മറ്റാരോടും പങ്കുവെക്കരുത് अपना पिन नंबर किसी को न बताएं Don't share your ATM PIN with anyone</p> </div>	<div style="margin-bottom: 10px;">  <p><b>ആദ്യം പരിശോധിക്കുക</b> <b>सतर्कता दिखाएं / INSPECT FIRST</b> എടിഎമ്മിൽ സംശയകരമായ എന്തെങ്കിലും ഉപകരണങ്ങൾ ഉണ്ടോ എന്നു നോക്കുക / ध्यान से देख कि एटीएम पर किसी संदेहजनक चीज तो नहीं लगी है Look for suspicious devices attached to ATMs</p> </div> <div style="margin-bottom: 10px;">  <p><b>ശ്രദ്ധിക്കുക / ध्यान दें / LOOK AGAINST</b> ഇടപാട് പൂർത്തിയായതിനു ശേഷം എടിഎം സ്ക്രീനിൽ വെൽകം സ്ക്രീൻ കാണപ്പെടുന്നുണ്ടോ എന്നു നോക്കുക / ट्रांजेक्शन पूरा हो जाने पर एटीएम स्क्रीन पर फिर से स्वागत संदेश उभर आता है Ensure Welcome is displayed on ATM screen, once transactions is complete</p> </div> <div style="margin-bottom: 10px;">  <p><b>പണം കിട്ടിയെന്ന് ഉറപ്പാക്കുക</b> <b>कैश न होने की पुष्टि करें / CONFIRM CASH OUT</b> പണം പുറത്തു വരാതെ എടിഎം 'കളക്ട് കാഷ്' എന്നു കാണുകയോണ്ടെങ്കിൽ ജോബിയിൽ കൊടുത്തിരിക്കുന്ന ഹെൽപ്പ്ലൈനിൽ വിളിക്കുക / अगर एटीएम कैश निकाले बिना 'कैश प्राप्त करें' का निर्देश देता है तो लॉबी में दिए गए हेल्पलाइन को कॉल करें/Call the helpline mentioned in the lobby, when ATM instructs you to 'collect cash' without dispensing it</p> </div> <div style="margin-bottom: 10px;">  <p><b>SMS അലർട്ട്/SMS അലർട്ട്/SMS ALERT</b> ഇടപാടുകൾ സംബന്ധിച്ച അലർട്ട് ലഭിക്കുന്നതിന് നിങ്ങളുടെ മൊബൈൽ നമ്പർ രജിസ്റ്റർ ചെയ്യുക / अपने नंबर को ट्रांजेक्शन अलर्टस प्राप्त करने के लिए रजिस्टर करें/ Register your number to receive transaction alerts</p> </div>
---	---

വിളിക്കുക/കോൾ करें / CALL 18004253800, 1800112211/ടോൾ ഫ്രീ / टोल फ्री / TOLL-FREE 09449112211  
 സന്ദർശിക്കുക/വിजिट करें / Visit : bank.sbi | ഞങ്ങളെ ഫോളോ ചെയ്യൂ/हमें यहां फॉलो करें / Follow us on 

Size: 15(w) x 20(h) inch

## 12. TYPE OF MACHINE STICKERS

Bilingual / Trilingual Stickers will be stuck behind the machine for identification.  
Example of machine-type stickers behind the machines:



Bilingual	Trilingual
	
 <p>2x1</p>	

<p>स्वयं पासबुक मुद्रण मशीन SWAYAM PASSBOOK PRINTING MACHINE</p> <p>2x1</p>	<p>സ്വയം പാസ്ബുക്ക് പ്രിന്റിംഗ് മെഷീൻ स्वयं पासबुक मुद्रण मशीन SWAYAM PASSBOOK PRINTING MACHINE</p>
<p>चेक संग्रहण मशीन CHEQUE DEPOSIT KIOSK</p>	<p>ചെക്ക് ഡിപ്പോസിറ്റ് മെഷീൻ चेक संग्रहण मशीन CHEQUE DEPOSIT KIOSK</p>
<p>सिक्का वितरण मशीन COIN VENDING MACHINE</p> <p>2x1</p>	<p>നാണയം വെൻഡിംഗ് മെഷീൻ सिक्का वितरण मशीन COIN VENDING MACHINE</p>

**13. Machine Wrap**

Base colour of the machine will be SBI INKY BLUE - RGB: R40 G0 B113;  
There should be YONO branding Sticker on the Chest part and visible sides of the machine, if the factory-made branding is not present.

Chest Design	Overall	Side facia of machine
		

--	--	--

**14. ELECTRICALS**

**Loose and exposed wiring if any should be taken through Rigid PVC conduit pipe suitably saddled/ concealed on wall/partition.**

**(a) CEILING LIGHTS**

- (i) All ceiling lights should be independently fixed / anchored to the RCC roof ceiling and not to be fixed directly on the false ceiling.
- (ii) Minimum Lux based on size of the room: at least 100 lumens per sq./ft
- (iii) Energy saving LED Panel lights should be installed.

Description	Make
36 W 2' X 2' LED light or higher as per lobby requirement	Phillips, Wipro, Crompton Greeves or equivalent

**(b) MAIN CABLING**

All Cables should be concealed from Public.

Description	Make
Fire Resistant Low Smoke (FRLS) copper cable of sizes 1.5 sq.mm, 2.5 sq.mm, 4 sq.mm (for AC), 3 core 10 sq.mm (for incomer)	Finolex, R. R. Kabel, Havells or equivalent

**(c) SWITCHES**

All Switches should be in Back room, inaccessible to Public.

Description	Make



Modular 5 Amp / 16 AMP Switches

L&T, Legrand or equivalent

#### (d) DISTRIBUTION BOARD FOR 3 PHASES

- (i) Should be in Back room, inaccessible to public.
- (ii) All distribution boards to be Double door type.
- (iii) MCBs used should be 'C' type for Air conditioners and input and output of UPS and "B" type for lighting circuits.

Description	Make
Incomer 40 Amp TPN DB with Outgoing MCB of 2 - 20 Amp, 4 – 10 Amp	Legrand, Simens, L&T or equivalent

- (iv) Modular distribution board comprising of Incomer 63 A Isolator (4 pole).
- (v) One Double Pole 32 A MCB at incomer & 3 outgoing 16A SP MCB controlled for CD, Emergency Light.
- (vi) 4 Nos UPS 6/16A Modular Switch Socket Output.
- (vii) 2 Nos, 25 amps modular PVC socket with top to be used for UPS Incoming & Outgoing.
- (viii) One more Double Pole 32 A MCB at incomer for 02 Nos 20A Metal Clad for ACs.
- (ix) One No 16A SP MCB should feed the supply to one no. 16A timer switch at night glow day off mode.
- (x) 1 Nos. 16A SP MCB should be available for general light & 01 No 16A SP MCB should feed the supply 2Nos 6/16A Modular Switch Socket at Raw Power.
- (xi) All wiring of ISI FRLS cables.
- (xii) Lighting points including circuit wiring with 1.5 Sq mm copper wire and for UPS and AC input and output wiring 4 Sq mm copper wire through cable manager.
- (xiii) All neutral & earth links should be of minimum 63A.
- (xiv) All switches, MCBs, ELCBs, cables to be ISI make: Legrand, GE, MK, L&T, Anchor Roma, Indokrupp, Crabtree, Finolex, Siemens or an equivalent standard/ make having the required service support.
- (xv) Single line diagram showing the lighting, power & UPS power distribution in CD room with size and ratings of wires, etc. to be provided.

#### 15. EARTHING

- (a) Earthing to be taken ~~from two opposite sides~~ for ATM machine and ~~dual~~ earthing to be done with ~~two separate~~ earth pits. Earthing of raw power circuit should not interfere with UPS neutral earthing to avoid damage to ATM software and other electronic equipment connected to UPS.

(b) 6 mm solid copper PVC insulated wire for extending from the earth pit to CD room using a 2 mm thick PVC 19 mm dia conduit.

(c) Maintenance- Free chemical Earthing: -

- (i) Based on Earthing Electrode with inbuilt copper strip/GEL/GAF based.
- (ii) Should have resistance < 1 Ohm and should be < 2V between neutral and earth.
- (iii) Suitable electrode be used as per the site requirements. Earth enhanced compound powder (Gel) with hardener to be provided minimum 20Kg per site/ Back Fill/Site Filled compound (BFC/BSC)- 100 Kg.
- (iv) Earthing Warranty for contract period.
- (v) The electrode should be minimum 60mm dia and 3 Meter length or 80 mm dia and 2-meter length.
- (vi) Dedicated earthing for each machine.

## **16. DATA CABLING**

Data cabling to be done using CAT6 cables. Conduit should be spaced at least 30 cm away from power wiring to avoid interference.

## **17. CONDUITING FOR VSAT/ LEASED LINES: -**

- (a) Providing & fixing of 25 mm dia PVC 2 mm thick conduit of ISI make with saddling complete for connectivity.
- (b) Conduiting off site ATMs in airports, metro stations to be done using metal GI conduits or as specified by the respective authority.

## **18. SIGNAGE WIRING**

Providing & fixing of 3 x 1.5 mm copper wire & 19 mm dia PVC 2 mm thick ISI conduit with all accessories like saddles, bends etc. 10 m

## **19. EXTERNAL BACKLIT SIGNAGE LIGHT**

(a) LED Light

(b) All drivers of LED lights used in Backlit signage boards to be suitably covered with fire resistant boxes (Sintex box) to avoid seepage / moisture. Internal wiring of lights to be done using FRLS wires in flexible conduits and conduits to be fixed on signage frame.

(c) The signage metal frame should be earthed on two opposite sides and properly earthed using bare copper.

(d) The power supply to back lit signage to be provided with 30mA ELCB to ensure tripping in case of short circuits.

## **20. EXTERNAL DIGITAL SIGNAGE SOLUTION (EDSS)**

Bank intends to opt for External Digital Signage Solutions (EDSS) at ATM sites as per its business requirement. Bidders shall arrange to install and maintain External Digital Signage Solution at the Sites advised by Bank to successful bidders, as per Bank's sole discretion. Bank may advise such site(s) time to time during the contract period. Bank shall pay additional Per Successful Transaction Rate as mentioned in the Appendix-F "Indicative Commercial Price Bid" wherever EDSS is installed and functional.

Major Requirements / Specifications are as under (Additional / detailed specifications and scope of External Digital Signage Solution given in **Annexure-8** in this RFP: -

- a. LED light panel to display all colours.
- b. Capable to work in all weather conditions.
- c. Capable to display static images, videos, scrolling messages, live stream etc. centrally and securely.
- d. The repairs, maintenance and display content updating whenever required to be done by the successful vendors.
- e. The bidder should arrange for testing the content to be displayed in digital signage, subject to approval of the Bank, before implementing at all sites. Bidder to ensure that no content without specific permission of Bank is displayed. No unsolicited / unwarranted content shall be displayed at any circumstances on EDSS. In case of non-compliance, penalty of Rs. 50,000 for each instance, alongwith any other penalty (ies) imposed on the Bank by any statutory body (ies), will be imposed and recovered from the bidder.
- f. 3D representation of the External Digital Signage placement is required to visualize the placing / need of static external signage along with Digital Signage. The static external signage will be necessary when the Digital Signage is not working.
- g. Separate Network connectivity to be provided for Digital Signage for Centrally pushing of contents, NOT the connectivity used for ATM(s). Bidder can use the connectivity used for e-Surveillance Systems. GSM / VPN 3G / 4G / 5G multi-SIM intelligent Router with bandwidth aggregator.
- h. Capable to send the contents centrally / remotely, else physical visits to update the contents at sites.
- i. Bidder shall provide a centralized dashboard for monitoring the contents being displayed on EDSS. Access to the centralized dashboard should be provided to the Bank.

- j. Reputed ~~ISI~~ BIS certified brands. The size of the External digital signage LED screen shall be advised by the bank for each such site. Size shall depend on the site, and it shall be minimum of 21 sq. ft.
- k. During the currency of the contract, the system should be upgraded at no extra cost to the Bank. Any technological upgradation in EDSS, more specifically due to regulatory / administrative requirement, no extra cost to be charged to the bank.
- l. To be able to integrate with the different systems of the Bank, such as Switch, ATM monitoring tool, etc., as per the Bank's requirement, at no extra cost to the Bank.
- m. Bidder shall provide high security software i.e., cloud hosting on reputed hosting services like AWS/Azure/Google etc if any required by the Bank.
- n. Bidder shall provide maintenance service to keep the EDSS in good and efficient working condition without any cost to the Bank.
- o. Bidder shall provide preventive and corrective maintenance of EDSS and shall carry out necessary repairs and provide Suitable replacement (equivalent or higher configuration) of defective part(s) / equipment as required without any cost to the Bank.
- p. Bidder shall have responsibility to upkeep the EDSS maximum time and also converting raw videos to required size, feeding into board and maintenance of cloud / software / SIM card etc.
- q. Bidder shall attend and rectify the Break down / repair / replacement of EDSS call(s) registered by Bank / Bank's representative within 2 4 days. Any repair / replacement / rectification / implantation task under EDSS advised by the Bank should be completed by the bidder within 2 4 days of intimation. Penalty @ ₹ 500 per day from the 3<sup>rd</sup>-5<sup>th</sup> day onwards per non-complied call(s) will be levied.

**Example of Static and Digital Signage Combination**

Static part of Signage	Digital Part of Signage
	

## 21. EXTERNAL SIGNAGE

External Signage is required on all sites. The Signage will be in ENGLISH PAN-INDIA except in Karnataka State. In Karnataka, it will be trilingual with KANNADA as the regional Language along with Hindi & English.

The salient features of the major components governing quality and uniformity of the signage are summarized below:

A) GI Boxing:175 mm deep using 24 Gauge powder coated GI sheet for TP, Bottom, and side panels and 26-gauge powder coated GI sheet as back panel.

B) Flex:3M Panagraphics -III/ Avery Dennison Flex -1 only

C) Vinyl: 3M Light Blue - SC3630-8859 and Dark Blue-3630-7625 Avery Dessison- Light Blue - 5600LD/0708B and Dark Blue-5600Ld/069B

D) LED: 0.72W, 8000K, minimum 70 Lumens per Module having minimum IP-64 rating of Osram / Tridonic **or equivalent**.

E) LED Modules spacing. Ensuring edge to edge illumination by providing minimum 2.50 LED modules psft of signage Elevation area.

Detailed specifications along with CDR file will be provided at the time of awarding contract.

### a. For Standalone ATMs



Example with regional language ONLY IN KARNATAKA STATE:



ബ്രാഞ്ച് എം. ടി. എം. ATM

**b. For e-Corner**



e-Corner

Example with regional language ONLY IN KARNATAKA STATE:



ಇ-ಕಾರ್ನರ್ ീ-കോർണർ e-Corner

**c. Lollipop Signage**

PHOTO BY ADRIAN WILSON

12.5B SIGNAGE SYSTEM: STREET LEVEL



SBI's double-sided outdoor flanges display the monogram on one side, and the service on the other. These are simple way-finders for high-density pedestrian areas at the street level.



Front & Back

## 22. ACCESSORIES

- a. Chair-1 Number good quality / branded plastic chairs with handles for Security guard;
- b. Ready make stainless steel Dust Bin -1 Number for waste papers.
- c. Fire Extinguisher - 1 No., 2 kg.
- d. Door Matt 1 number.

## 23. SPLIT AIR CONDITIONERS (INCLUDING PIPING)

- (a) There shall be at least 2 brand new Split ACs with automatic timers for toggling between them.
- (b) All Copper, drain pipes of ACs should be concealed.

Description	Make
1 Ton dual Inverter Split AC (white colour) with remote with 5 Star rating, Indian Seasonal Energy Efficiency Ratio (ISEER) 4.5 and above. Or 1 Ton dual Inverter Split AC (white colour) with remote with 5 Star rating, ISEER 4.5 and above. All Weather AC (hot and cold) to be installed at places experiencing cold winters (less than 5-degree centigrade temperatures) especially in North & Northeast India.	Blue Star, Voltas, Daikin, Hitachi, Carrier, Mitsubishi, Panasonic or equivalent
<b><u>Stabilizer for AC: -</u></b> Compact Stabiliser 4 KVA. ISI make or from ISO certified company-1 No for both the ACs	
<b><u>Timer</u></b> Timer used should be 24-hour dial type day timer with manual adjustment for running the air conditioners alternately every 4 hours.	L&T, Siemens or equivalent

### **Stand for A/C condenser units:**

M.S Stand. 50 mmX50 mm X 6 mm.  
MS stand should have two coats of Zinc Chromate primer and two coats of Enamel paint preferably Black.

The power supply to air conditioners should be taken through 25 amps rate contactor with 230v AC coil. Only control supply of coils should be taken through timer. Main power for AC units shall be through contacts of the respective contactor. The whole assembly of contactor and timer should be enclosed in MS box and mounted on wall.

The flexible cabling between indoor and outdoor units should be taken separately and not to be clubbed with hot and cold refrigerant piping. This is to avoid melting of cables / wires leading to short circuits.

### 1. UPS & BATTERIES

(a) The UPS & Batteries are to be kept in Back room. A back room required for keeping all peripherals like UPS, Batteries, Modems, e-Surveillance panels etc.

(b) The battery back-up capacity will depend on the main power supply in that area.

(c) UPS should have Simple Network Management Protocol (SNMP) for polling, wherever SNMP cards are provided for UPS and necessary feed is received

Description	Make
<p>Atleast 2 KVA UPS with minimum 8 hours SMF / Lithium-ion fast charging batteries back up.</p> <p>Microprocessor / DSP based Online UPS atleast 2 KVA Single Phase with Isolated output, SNMP enabled with Software to facilitate completion of last transaction before gracefully shutting down the ATM.</p> <p>Technical Specifications:            Input Voltage Tolerance: 120-290 V.            Input Frequency Tolerance: 47Hz to 53Hz            Output Voltage: 230 V +/- 1% No Load to Full Load.            Output Frequency: Mains Synchronised / 50Hz+/- 0.05% in free running mode.            Overall efficiency: &gt; 90% AC to AC.            Recharge Time: &lt; 12 Hours up to 90% Capacity.            Overload Capacity: 110% for 1Minute, 130% for 1Sec            Total Harmonic Distortion: &lt; 4%,            Output Filtration: RC &amp; EMI</p>	<p>Numeric, Epoch, Novateur, Tritronics, APC, DB, Emerson, E &amp; C, Techser, Aplab or of any equivalent make and having a good service network across the country. SMF / Lithium-ion batteries of Hitachi, Rocket, Panasonic, Exide powersafe, AmaraRaja, Amco Best, Numeric, U_PLUS, HBL, CSB, Newmax (all with 18 months warranty) or of any equivalent make and having a good service network across the country</p>



Protections: Short Circuit, Overload, Low Battery, Over Charge.  
 With Audible Alarm for low battery and inverter trip.  
 Temperature tolerance: 10 to 45 degree C for the UPS  
 Humidity tolerance: <math>\leq 90\%</math> non-Condensing  
 Indications Digital Display:  
 AC I/P O/P Voltage, AC I/P O/P Current, DC Voltage, DC Current & Battery Status  
 Special Requirement: Auto restart at Mains after Low Battery or Overload, Cold start at 90% of the rated load.  
 4 hours battery back-up. Min VAH: 8600

**25. OUT OF ORDER MESSAGE AND NEAREST BRANCH DETAILS**

- (a) Whenever any machine is not working, a board with out of order message to be displayed.
- (b) A separate board informing the nearest branch and ATM lobby to be displayed in the room. These details should be printed instead of hand-written and must be updated regularly whenever there are changes in the nearest branch or ATM lobbies. Refer the creatives, as under:

Bilingual	Trilingual
<p>             मशीन कार्यरत नहीं है,              कृपया नजदीकी एटीएम लॉबी/              ई-कॉर्नर पर जाएं.  <b>Machine is out of order,              please visit nearest ATM              Lobby/e-Corner</b>              असुविधा के लिए खेद है  <b>Inconvenience is Regretted</b> </p> 	<p>             മെഷീൻ തകരാറിലാണ്,              ദയവായി അടുത്തുള്ള എടിഎം              ലോബി/ഇ-കോർണർ സന്ദർശിക്കുക              मशीन कार्यरत नहीं है,              कृपया नजदीकी एटीएम लॉबी/              ई-कॉर्नर पर जाएं.  <b>Machine is out of order,              please visit nearest ATM              Lobby/e-Corner</b>              അസൗകര്യമുണ്ടായതിൽ വേദിക്കുന്നു              असुविधा के लिए खेद है  <b>Inconvenience is Regretted</b> </p> 

निकटतम एटीएम NEAREST ATM 1) _____ 2) _____  संबद्ध शाखा का संपर्क नंबर Contact number of Linked Branch _____	ഏറ്റവുമടുത്തുള്ള എടിഎം നिकटतम एटीएम NEAREST ATM 1) _____ 2) _____ 3) _____  ലിങ്ക്ഡ് ബ്രാഞ്ചിന്റെ ബന്ധം നമ്പർ संबद्ध शाखा का संपर्क नंबर Contact number of Linked Branch _____
--	---

**26. TERMINAL ID**

- The Terminal ID assigned to the machine to be stuck on the machine.
  - White Font on Ink Blue {RGB: 40 0 113} background. Use Font type in Capital letters: Times New Roman
- Example:

**S1BW008586001**

**27. Complain Platforms, Common Error Codes, VAS, Free Services, Usage creative**

- A comprehensive creative displaying the above (Annexure-F) should be displayed on one of the side walls of the ATM Lobby.
- Size of this creative should be approx. 1.5 meter length by 1.5 meter breadth.

**28. Wall Mounted Sanitizer dispenser**



In case of any mandate by IBA/RBI/Govt. of India/ State or District Govt./ any statutory body etc., Vendors to provide wall mounted sanitizers with Govt. approved sanitizer liquid/gel and maintain it, at no additional cost to the Bank.

#### 4.2 e-SURVEILLANCE SYSTEMs (eSS)

- 1) To implement a tested and proven technology solution for Comprehensive Centrally Monitored Electronic Surveillance of ATM installations operated and managed by vendor to detect, deter and avoid theft, burglary, fraudulent transactions, vandalism etc. in & around ATM premises and to detect Intrusion or carrying out unauthorized activity in ATM and around premises.
- 2) Separate network connectivity to be provided for the e-surveillance system. The connectivity used for the ATM should NOT be used for e-surveillance system. All Network Security requirements mentioned for ATM connectivity is applicable for e-surveillance system connectivity. Continuous connectivity between the Command Centre of eSS and the ATM site by implementing the necessary connectivity solution as mentioned in this RFP for ATM connectivity.
- 3) Bidder to ensure that connectivity solution / technology should be capable of high-quality live view / live streaming of all CCTV cameras through dashboard / Mobile app as well as support daily backup of footages.
- 4) Adequate number(s) of CCTV camera(s) should be provided for full coverage including but not limited to undernoted cameras:
  - a. in main ATM room,
  - b. outside the ATM room- covering all entrances and its near proximity / surroundings, full External Signage(s) including EDSS,
  - c. in the ATM Back room,
  - d. hidden Pin-Hole Camera(s) at a suitable concealed location(s) inside the main ATM room.
  - e. hidden camera(s) focussing on cash slot of each machine to ascertain cash dispensation and collection of cash by the customer.
  - f. Bidder to ensure that no camera should be focussed on the keypad of machine to capture the PIN being entered by the customer.
- 5) All Cameras should be IP Cameras with High Resolution (at least ~~3840 x 2160~~ 2688 X 1520-pixel resolution or above) and should be able to record clear images and videos in all scenarios including dull light, no light at ATM site or the bright light from the background. While viewing the site in real time through CCTV surveillance from Command centre / dashboard / mobile app of the vendor, there should be no interruptions due to connectivity / Bandwidth related issues.
- 6) Detection of Intrusion in the ATM premises or disturbing the installed equipment(s) such as ATM Machines, ACs, UPS & batteries, external signages etc. and all other installed equipment(s) under e-Surveillance. All machines at the ATM sites to have removal, vibration, contact and thermal sensors.
- 7) **Panic Button:**

- a. Installation of red colour Panic button at Main ATM room. Following notice (in red colour font) to be displayed prominently next to the panic button:

<b>PANIC BUTTON NOTICE:</b>
-----------------------------

<b>IN CASE OF ANY EMERGENCY, PRESS PANIC RED BUTTON</b>
---

- b. On pressing the red panic button, the following to be done:
- i. Sounding the hooter installed in the ATM room.
  - ii. Alerting the command centre of Vendor to take the site under live monitoring to ascertain the emergency and take appropriate steps.
- 8) Detection of lingering or unauthorized activity for more than two minutes, motion-based monitoring 24x7x365 using video analytics. Additionally, monitoring using motion detectors through PIR (Passive Infrared) sensor from 8 PM to 8 AM.
- 9) To detect the loitering inside the ATM lobby and initiate appropriate actions to deter the same.
- 10) To detect and deter a person wearing helmet, covering / masking the face, trying to carry out any unauthorized or suspicious activity. The command centre should warn the person to remove helmet, mask, etc.
- 11) To manage the crowding in the ATM site. If more than designated persons are present at ATM sites (one person per machine at a time), appropriate announcements should be made and appropriate action to be initiated to control the situation.
- 12) Required Sensors and Devices: Appropriate actions to be taken whenever alerts are generated by the sensors-**
- a) ATM1, ATM2 and more Removal Sensors (Metal Contact Sensor),
  - b) ATM1, ATM 2 and more seismic sensor / vibration sensor Zone (to work with UL 291 Business hour and UL 291, 24- hour ATM chest and CEN 1 or any other type of ATM safe),
  - c) ATM1, ATM2 and more Chest Door Zone (Plastic / Metal Contact Sensor). Whenever chest is opened, the centralized command centre will take site in live monitoring to ascertain the genuineness of the activities. The CRA / CIT personnel(s) will show their valid ID card to the Centralized command centre executive. For unauthorized access, appropriate steps to be taken by the centralized command centre of Vendor.
  - d) Hood Door (upper and down) open sensor to detect opening / tampering of the hood. Whenever hood(s) is / are opened, the centralized command

centre will take site in live monitoring to ascertain the genuineness of the activities. The Engineer / authorised personnel / CRA / CIT personnel(s) will show their valid ID card to the Centralized command centre executive. For unauthorized access, appropriate steps to be taken by the centralized command centre of Vendor. An alert ticket must be raised if Hood door is opened at any time of the day and whole activity should be recorded as a continuous video.

- e) ATM1, ATM2 and more Thermal Sensor with Rate of rise feature
- f) ATM Back Room Sensor(s) to detect unauthorized access into the room through the back-room door (Metal contact Sensor),
- g) Removal Sensor Cheque Drop Box (if present), UPS and Battery (Metal contact Sensor).
- h) CCTV 1, CCTV 2 or more (with IR Vandal Proof Dome Cameras), Speaker & Microphone removal Zone in series.
- i) Speaker and mic Removal Sensor (Plastic / Metal Contact Sensor)
- j) PIR Motion Sensor/ Occupancy Sensor
- k) Siren / Hooter
- l) Panic Switch / Duress Button at Main lobby of ATM site
- m) Air Conditioner On / Off sensors (Recording of Date & Time)
- n) Signage On / Off sensors (Recording of Date & Time)
- o) At least 10 Hours internal battery Back-up for Alarm Panel, Router, Microphone, Speaker, DVR and all Cameras etc.
- p) Mains and UPS power sensing ability (Power Input Sensor- Mains Input (ON / OFF) (Silent Zone)
- q) Speakers for playing any pre-recorded messages at the site whenever required by the Bank. Vendor to arrange for creation of any pre-recorded message as desired by Bank.

- r) Vendor may install any other sensor to ensure the Security / safety of the site.
- 13) Video Verification by viewing images of site on above event.
- 14) Vendor to Store / preserve Images / Videos for Verification for minimum 180 days at centralized location / Cloud. Vendor to preserve & provide the CCTV footages (images and videos) & ATM's DVSS images for all disputed transaction / vandalism / Theft cases / other cases till they are closed / resolved even beyond the period of 180 days if so required. To provide images and video footages on demand of the Bank. As soon as CCTV images / videos request is received by vendor, they have to mark it as disputed and shall retain it and make it available even beyond 180 days and till the closure of the case. Every month, vendors will inform the Bank about ATM ID wise images / videos retained beyond 180 days and deleted thereof. The TAT for providing images / footages to the Bank is within **3 Calendar Day** of receipt of such requests from the Bank.
- 15) Vendor shall arrange to upload / provide CCTV / DVSS footage(s) to portal / dashboard / Bank, as per the TAT (**3 Calendar Day**) defined above wherever required by the GOI / Bank / Law enforcement agency(ies) / I4C (Indian Cyber-Crime co-ordination centre) etc.
- 16) Vendors to provide the facility (Web based as well as Mobile app based) for viewing & downloading the live footages to the authorised Bank officials / representative of Circles / CC / GITC, by selecting ATM ID. For viewing the stored images & footages, option should be provided by entering the ATM ID, Date & Time of images & video footages.
- 17) Central Monitoring Station of e-surveillance must have the ability to daily pull images and videos centrally from centralized location / cloud, site DVR and provided to the Bank as and when demanded.
- 18) Storing of ticket related notes of conversation with various parties for 30 days. Storing of suspicious / criminal events beyond 180 days, till the closure of the case and submission of reports to Bank authorities.
- 19) Use of 2-Way Audio to deter the attempted crime and the system should be highly capable of clear voice / sound quality and there should be no disconnection even if the connectivity is lost with the command center.
- 20) Installation of Siren to scare away the culprits if they do not respond to 2-way communications.

- 21) Installation of fire / smoke detector. Telephone Escalation to related parties on continuation of crime in case of Fire / Smoke. To contact local police authorities or local fire station. To generate an alert in case of Fire / smoke and to switch on / off Main and UPS power.
- 22) SMS and Emails to Bank official by Vendor Management Centre on receiving an alert as per procedure advised by the Bank.
- 23) Twice a day video footage of housekeeping to know the clean / unclean status of the site and to provide the related reports to the Bank.
- 24) Providing mutually agreed reports and vendor is under obligation to provide audio video footage as per the requirement of the bank. Bank may ask to provide any report as and when required and bidder should be capable of developing the same at no extra cost to the bank.
- 25) The offered system should have various reporting capabilities such as E-surveillance System down report, ATM wise alert reports, Ticket transaction reports, Mains Power Cut report, Chest Door open report, Hood open report (upper and down), Housekeeping Attendant report and CRA attendance report and connectivity / Link uptime report etc.
- 26) The e-Surveillance vendor will be solely responsible to provide such information or footage or image or reports to the police or other regulatory authorities on demand.
- 27) Quarterly Preventive maintenance of e-Surveillance equipment shall be carried out by the vendor.
- 28) e-Surveillance Systems (eSS) should be functional / operational 24x7x365. If any deficiency observed / found by Bank / Bank's representative, a penalty of Rs ~~2,000/-~~ 1,000/- per instance per site shall be recovered from the Vendor.
- 29) Vendor shall mandatorily provide Web Dashboard and Mobile App access to for:
  - a) to view the ATM sites live by Vendors and by dedicated users including Bank official,
  - b) to know the status of offline / online e-Surveillance sites and sensors / equipment installed at machines / sites. The entire responsibility of monitoring of dashboard and taking compensatory measures rests on the vendor and Vendor shall be responsible for any loss / damage in this regard,

- c) The Bank may integrate the e-surveillance installed at Endpoint sites with its own e-surveillance dashboard / solution. The Vendors should co-operate with the integration conforming to Bank's IS policy at no additional cost to the Bank.
  - d) Bidders need to provide its dashboard at bank's premises / location(s) and the dashboard(s) being provided by the bidder, if required, should be able to be integrated with the existing e-surveillance dashboards of the Bank at no extra cost to the Bank.
  - e) To access the dashboard through smart phone apps as well as web view.
  - f) To know the status of offline / online sites and duration of downtime (from date / time – to date / time) in case of offline sites. User should be able to download details of such sites in the excel file.
  - g) To be able to provide the ATM related data, such as ATM ID, Location, Address, Contact details, peripherals / equipment in room etc. in the downloadable format as advised by the Bank.
  - h) Capability to lodge the request for requisition of CCTV images / video footage in a dashboard by the authorized user of the Bank.
  - i) Vendor should arrange for a single dashboard for above services.
- 30) The Bank or bidder may require to:
- a) Shift Endpoints to new location;
  - b) Add new machine(s) at existing location;
  - c) Replace old ATM machine(s) with new one;
  - d) ~~Renovate~~ Refurbish / renew ATM Site,
- In all the above mentioned cases, the bidder must Dismantle / Add / Replace / Shift / Reinstall the same / new equipment / sensors at existing / new location, as the case may be, without any cost to the Bank.
- 31) The dated and time stamping should be available on all images and video footages.
- 32) All wirings must be concealed and not accessible to an outsider. If any equipment loses its connection with the command centre, command centre should be able to identify the same within maximum 2 minutes. Antenna, if any, should be kept in protected environment and not be accessible by customer / public / outsiders / animal.



- 33) During the currency of the contract, the system should be upgraded at no extra cost to the bank. Any technological upgradation in CCTV, more specifically due to regulatory / administrative requirement, no extra cost to be charged to the bank.
- 34) Preventive maintenance of all the equipment covered under this scope to be carried out quarterly and a mobile application to be developed to submit the PM report to the concerned Circle authorities and the same to be linked with the real-time dashboard.
- 35) For any new feature of e-Surveillance which is not available under existing e-surveillance sites, Service providers need to carry out PoC at their own cost.
- 36) Capability to instantly detect the disconnection of Alarm Panel at ATM site, (such as wire cut, etc.) or disconnection of any of the critical sensor from Alarm Panel and initiate appropriate and corrective actions to detect the reason of disconnection and in the event of occurring of any crime, escalation to the related parties (Police authorities / Bank Officials), to deter / prevent the crime.
- 37) Capability to instantly detect the disconnection of CCTV from the Command Centre or non-recording of Videos and images locally at the ATM site or video loss / blacking out / masking the CCTV by any miscreant, and to take appropriate action in case of occurrence of any of the case mentioned as above.
- 38) Capability to instantly detect if view of the camera / Camera angles has been deviated or / and covered by any means as per original installations and to initiate appropriate action immediately.
- 39) The bank may require the Command Centre to inform the Bank's ATM Switch Centre to cease the operations at a suspected site, in case any suspicious activity is detected by the Command Centre.
- 40) System should be capable of preventing the malware attack on the network / data / Command centre of the Vendor / e-Surveillance partner.
- ~~41) An alert must be raised in case someone blocks or tampers with the cash dispenser / cash shutter of the ATM machine to manipulate the cash being dispensed by ATM machine. Whole activity should be recorded as a continuous video.~~
- 42) An alert must be raised in case someone tries to disconnect the ATM machine by removing power cables or switching off the ATM machine, etc. Whole activity should be recorded as a continuous video.

- 43) To know the health status of the all the installed sensors and equipment, such as 2-way communication system, hooter, CCTV, all the installed sensors, etc.
- 44) To show the live location of the site on google map. Installation of a GPS device at the endpoint site which will provide the latitude and longitude of the site at real time, which will be useful for SBI Finder App / Websites.
- 45) A notice prepared elegantly (as provided by the Bank under SIS creatives) to the effect that the site is under electronic surveillance shall be displayed at the entrance and inside the ATM room.
- 46) To maintain the database by mapping the ATM IDs with e-Surveillance site ID. In case of any mismatch, to co-ordinate with the Circle authorities for necessary reconciliation.
- 47) To detect any kind of tampering with the equipment installed at ATM site.
- 48) To be able to integrate with the different systems of the Bank, such as Switch, ATM monitoring tool, etc., as per the Bank's requirement, at no extra cost to the Bank.
- 49) Capability to lodge online complaint regarding the faulty equipment, faulty sensors, down / dismantled sites, unclean sites, shutter remaining opened / closed, signage boards / Air Conditioners / lightings not switched on/off, etc.
- 50) Every data related to ATM sites, should be available on both, i.e., bidder's portal as well as Bank's Centralized dashboard, if any.
- 51) Should have a documented and tested **Business Continuity Plan (BCP)**, a Disaster Recovery site according to **Disaster Recovery Plan (DRP)** and the documents related to both BCP / DRP should be submitted to the Bank.
- 52) The switch over from Primary Command Centre to DR command centre should be within 30 minutes.
- 53) To keep a check on the health of the e-Surveillance equipment / sensors and if required, necessary steps to be taken to ensure that the same is replaced / repaired / rectified within a maximum period of 24 hours from the time of fault occurrence.
- 54) Vendor shall submit the Security Clearance Certificate of **full infrastructure of eSS** from CERT-In empanelled Security Auditors annually.

#### **55) Energy and Power Management Solutions at sites:**

- a. To manage and monitor the power consumption on month-to-month basis and provide report whenever required by Bank.
- b. To monitor the status of Signage, Air Conditioners (AC) and Lightings in the ATM room and to control the same by switching off / on, remotely from the Command Centre, manually or automatically, as per schedule specified by respective local ATM teams. The Bank may use this solution for any other site control measures also.
- c. The vendor should be able to identify if the AC is not switched on even after executing the 'switch on' command and it should be able to send SMS / e-mail / Mobile App alerts etc. to designated persons (of vendor) in case of such failures and ensure it is rectified at the earliest.
- d. To monitor the status of the Mains and UPS power and to switch on / off the Mains and UPS power, for the activities like, but not limited to, in case there is a) water logging inside ATM room, b) if suspicious activity is observed which could lead to fraudulent transaction / theft / burglary / vandalism, or as required by the Bank.
- e. The solution should have the capability to identify the failure of the commands executed automatically or manually from the command center, in order to initiate any of the services under Energy / Power Management solution. E.g., AC / Signage / lightings could not be switched off / on, in such cases system should have the capability to communicate the same through SMS/Email to the designated person.

#### **56) Secured Cloud / Central Storage of e-Surveillance Data including CCTV footages (for all ATM sites):**

- a. To provide Secured cloud / Central Storage of e-Surveillance data, including CCTV footage of all the sites covered under e-Surveillance solution irrespective of the vendor. Such storage facility (i.e., physical premises) should be within India only and should not be sourced from outside India.
- b. Bidder shall provide high security software i.e., cloud hosting on reputed hosting services like AWS / Azure / Google etc. conforming to Bank's IS policy and Bank's Cloud Policy.

#### **4.2.1 Templates of Reports to be provided by Vendor (Reports can be added/modified as and when required by Bank):-**

- 1) Date-wise All Ticket Report with all details that include Date and Time of Alert (To Corporate Centre and LHO)

Date:

Circle:

Date	ATM ID	Circle	Region	Location	Event Occurrence Time	Event Closure Time	Nature of Alarm	Total time taken to close	Whether 2 way audio used (yes/No)	Operator Comments (Whether crime prevented, Reported to Police/ Fire Station etc, Telephone escalations.)

2) Daily deterrence Ticket Report

CIRCLE:

Date	ATM ID	Circle	Region	Location	Event Occurrence Time	Event Closure Time	Nature of Incidence	How the incidence is deterred	Details of Damage to property/ injury to person, if any	Operator Comments (Reported to whom etc.)

3) Chest Door/ Back Door/ Cheque Drop Box (CDB) Open Report with all details that include Date and Time

CIRCLE:

Date	ATM ID	Circle Region	Region	Location	Open Time	Close Time	Whether chest door, back room or CDB	Whether authorized (Y/N)	Authorized by	Operator or Comments

4) Daily e- Surveillance System down report with all details

CIRCLE:

Date	ATM ID	Circle Region	Region	Location	System down from (time)	System down upto (time)	Reason (Power /Networking /Hardware/ Software etc)	Whether Bank has revised to stop Surveillance (Y/N)	Whether power supply inadequate for battery charging (Y/N)	Operator comment (Action taken to resume, when to resume etc)

5) Daily MAINS Power Report

Circle:

Date	ATM ID	Circle	Region	Location	Mains Power down from (time)	Mains Power down up to (time)	Operator comments

6) Daily Video housekeeping Reports:

CIRCLE: MS Service Provider:

Date	ATM ID	Circle	Region	Location	Time cleaning started	Time Cleaning finished	No. of times the room	Quality of cleaning (cleaned Floor)	1 <sup>st</sup> or 2 <sup>nd</sup> cleaning on	Operator or comments (inform

								to be cleaned per day	only/glasses also)	this day	ed Channel Manager etc.)

7) Consolidated Monthly Performance Report

CIRCLE:      MONTH:

Date	ATM ID	Circle Region	Region	Location	No. of deterrence during the month	No. of instance, 2 way audio used	No. of system down instance during the month	No. of instances excluded for penalty	Penalty to be recovered	Operator comment (Details of crime prevented, Reported to Police. Fire Station etc. telephone escalations)

8) Penalty Calculation Sheet (For Instance not excluded)

CIRCLE:      MONTH:

Date	ATM ID	Region	No. of instances more than 30 min. less than 24 hours	Penalty (10%)	No. of instances more than 24 hours less than 48 hours	Penalty (50%)	No. of instance more than 48 hours and less than 72 hours	Penalty (100%)	Penalty to be recovered
1	2	3	4	5	6	7	8	9	10 = (4*5) +

									(6*7) + (8*9)

9) Daily Installation Progress Report (Monthly report also to be compiled in the same way)

CIRCLE:

Date	ATM ID	Region	Location	Channel Manager Name	PO Date	Number of installations completed during the month including this ATM	Number of installations Completed from the beginning including this ATM	Target for the month	Remaining number to be completed before March 2023

10) Monthly Availability Report:

Service Provider:      Month:

SI	Circle	ATM ID	Location	Region	Rural/Semi Urban/Urban/Metro	Monthly Availability

Format site maintenance and housekeeping

## 4.3 Site Maintenance Services:

### 4.3.1 Site Maintenance: -

**4.3.1.1** The Vendor should ensure maintenance of ambience of ATM site in such a manner that it should look like new throughout the contract period and extension thereof.

**4.3.1.2** In case of any mandate by IBA / RBI /Govt. of India / State or District Govt. / any statutory body etc., Vendors to provide wall mounted sanitizers with Govt. approved sanitizer liquid / gel and maintain it, at no additional cost to the Bank.

- 4.3.1.3** Cleaning of Signage / Lollypop at least once in a month and whenever necessary, it should be clean more than one time in a month in such a manner that it looks like Brand New.
- 4.3.1.4** Pest control / anti-rodent treatment shall be undertaken minimum once every quarter along with the preventive maintenance of the machines.
- 4.3.1.5** In the process of providing these services, Vendor undertakes to use good / standard quality of Pest control / anti-rodent treatment material. No material will be kept in the direct view of the customer.
- 4.3.1.6** Arrange to get publicity materials, banners, posters etc. supplied by the Bank or create them as advised by the Bank, to be displayed at the endpoint site as per instructions besides replenishing leaflets, brochures etc. The Bank shall be providing the open artwork files to the bidders and the necessary instructions for their display. Bidder to print them and implement at the sites.
- 4.3.1.7** Electrical and lighting maintenance like replacing lights, tubes, bulbs, holders, electrical switches, starters, chokes, etc. as and when required. The problems with the lights including replacements are rectified within 4 hours.
- 4.3.1.8** All lights within the room and outside like Backlit signage, Glow sign boards and all other lights are functioning at all times.
- 4.3.1.9** Conducting earthing checks and it should be perfect as define in this RFP and as per the requirement for smoothing functioning of ATMs and its peripherals.
- 4.3.1.10** General maintenance of UPS, AC units, flooring, ceiling, Leakage / Seepage, Signage repairs/replacements, replacement & maintenance of Door closures, lights, etc.
- 4.3.1.11** Preventive Maintenance at least once in a quarter under advice to the bank. Replenishing posters, stickers as and when required as when required by the Bank and provided the Bank.
- 4.3.1.12** Bank officials will inspect the site a least once in a month. The vendor should repair / replace the defective / non-functioning furniture, fittings and equipment within two days of the official communication to the Vendor.



- 4.3.1.13** The Vendor and / or his equipment suppliers / agents / partners should have presence in major cities / district headquarters with support offices and spare part supply depots.
- 4.3.1.14** The Vendor and / or his equipment suppliers / agents /partners should have adequate number of engineers and trained personnel to ensure quick resolutions and minimum downtime.
- 4.3.1.15** Arrangement for opening and closing rolling shutters at ATM sites at the designated timings as advised by the Bank. Closing of ATM site in case the machine is awaiting repairs and not available for customer transactions.
- 4.3.1.16** Placing “Temporarily out of service” board (as per the creative detailed in this RFP) when the machine is made inactive by the Bank or is out of service for any reason. The board should be removed when the machine is LIVE and working.
- 4.3.1.17** Vendor shall ensure cleaning of ATM and its peripherals e.g., ENDPOINT exterior, LCD / CRT screen, air conditioners etc. in such a manner that these items shall always look and work as a brand new.

#### **4.3.2 Caretaker Services:**

- 4.3.2.1** Caretaker Services are not required under the scope of this RFP; however, Selected Vendors are required to provide caretaker services at no extra cost to the Bank in the emergency requirement or wherever the same is needed by the Law Enforcement agencies or the Bank.
- 4.3.2.2** The vendor must ensure that all applicable laws framed by the Central Government, State Government and Local Bodies, including payment of applicable minimum wages and all laws pertaining to contract employees/ labour laws are complied with while providing caretaker services. The vendor may have to execute an indemnity bond in favour of the Bank in this regard.
- 4.3.2.3** If the Vendor proposes to engage services of other agencies, full details of all contractor’s parties to be enclosed.

#### **4.4 Housekeeping Services (Optional Item): -**

- 4.4.1** Housekeeping services shall be optional in nature. Bank may reserve the right to take housekeeping services as per the Bank's requirement at some or all the Site(s) as per the derived rate in this RFP under optional items.
- 4.4.2** The derived additional rate under price bid will be applicable throughout the contract period and extension thereof, and Bank may use housekeeping services at identified Site(s) initially or anytime during the contract period and extension thereof.
- 4.4.3** Housekeeping services comprises Cleaning of both customer area & back room and immediate surroundings; cleaning of all items in kiosk e.g., visual merchandise, signage (including external signage), floor, glass, walls, cleaning of wastepaper basket, etc., to ensure that the kiosk presents a neat and clean appearance. All surfaces shall be maintained clean and particularly glass surfaces shall be maintained sparkling clean. Cleaning material should be arranged by the bidder.
- 4.4.4** Cleaning includes flooring, glass door, laminates, ceiling, Fan, if any, dusting of ATMs and its peripherals / other fixtures / Signage / Lollypop inside ATM room and Outside the ATM lobby.
- 4.4.5** Removal and cleaning of any cobwebs, Beehives, Anthills, Termite lines etc. inside and outside the ATM lobby.
- 4.4.6** The Vendor should ensure cleaning under Housekeeping Services of ATM site in such a manner that it should look like new throughout the contract period and extension thereof. All cleaning and other supported material shall be arranged by Vendor.
- 4.4.7** In the process of providing these services, Vendor undertakes to use good / standard quality cleaning material. No housekeeping material will be kept in the direct view of the customer.
- 4.4.8** All sites shall be cleaned minimum **twice a day for Regular ATMs and thrice a day for VIP ATMs** and report through Online Portal or Mobile Application. At high-transacting machines or during monsoon seasons (irrespective of Regular / VIP categories), the bidder may have to increase the number of

cleaning schedules in a day (more than the minimum specified in this clause), in such a manner that the lobby is always maintained clean and tidy.

**4.4.9** Bank shall withdraw housekeeping services, if allotted, anytime during contract period and extension thereof by furnishing one month notice to bidder(s).

## **4.5 Managed Services for Endpoint:**

### **4.5.1 DEFINITIONS**

- i. **“ATM Loss Liability Limit”** means the maximum amount of Service Provider’s liability for an ATM Loss. The ATM Loss Liability Limit is Rs. 60,00,000/- (Rupees Sixty lacs only) per ATM.
- ii. **“Business Day / working day”** means a day which is not declared as Public Holiday under NI Act.
- iii. **“Public Holidays”** shall mean public holidays, at the place where the Equipment is located, when banks are closed for business.
- iv. **“Endpoint”** shall mean the ATM / Cash Recyclers (with the configuration as specified in Appendix-C of the RFP, wherever applicable) supplied by the Endpoint Provider.
- v. **“First Line Maintenance (FLM)”** is defined in this appendix.
- vi. **“Occurrence”** means a single event or a series of related events resulting in a loss or losses.
- vii. **“Response Time”** means interval between the Bank / MVS vendor’s call to the successful bidders (and / or their sub-contracted vendors) and their arrival at the ATM.
- viii. **“Bank Preventable Calls”** means a service call to Endpoint / Service Provider and / or their subcontractors, if any. Bank preventable calls include but are not limited to, calls for FLM to replenish supplies, calls to CRA / CIT Agencies etc.
- ix. **“ATM Software”** Shall mean OS (Operating System) / XFS layer / Devices / Drivers / Terminal diagnostic tools / utilities / patches provided by Endpoint provider for smooth running of software.

Vendor may have to take over existing sites from Bank’s existing MS / BLA / TOM Vendors (in case the same does not belong to it already) to provide the Services as mentioned in this RFP. Vendor to ensure that all kind of up-to-date dues, statutory or otherwise, are paid by existing Vendor. Vendor to note that at any stage, Bank shall not be responsible of any such dues. Vendor to Submit the following Certificate duly completed and signed whenever taking over an existing site or providing services at any

new site. This report is also required to be uploaded / keyed-in at Online Monitoring System of the Bank.

<b>CERTIFICATE FOR MACHINE &amp; SITE DETAILS</b>		
ATM ID		
Machine type	ATM	
OLD ATM id (if Any)		
Date of Installation		
Machine Supplier Vendor		
OEM/manufacturing Vendor		
TOM Vendor		
Model Name & Serial no.		
Phase	Phase-17	
Installation Location (Tick if applicable)	Airport	Shopping Mall or Complex / Movie Theatre
	Intouch	Bus Stands
	Railway Station	Market area/Bazaar
	Metro Station	Govt. Building/ Govt. office
	Army/Defence Area	Main Branch
	Petrol Pump	
ATM Site Type		
	E-corner Offsite	Offsite
Installation Room	Branch Lobby	Cabin
	Window	E-corner
	Intouch	
Ramp Available for Disable?	Yes	Not required (at ground level)
CCTVs available	Yes	No
E-surveillance System installed	Yes	No
Security Guard	Yes, Time shift_____	No
Backroom Available	Yes	No
Are all electrical wires, UPS, switches, network cables, modem in back room?	Yes	No

No. of existing machines at site (exclude this new machine)	No. of Existing Endpoints	No. of Existing ATM
	Total Machines at site	
Full Site Address		
District		
City		
State		
Circle as per SBI		
Pincode		
Latitude (upto 6 decimal)		

Longitude (upto 6 decimal)		
Cash Replenishment	CRA Name _____	
Joint Custodian 1 name		
Mobile No.		
Employee no.		
Joint Custodian 2 name		
Mobile No.		
Employee no.		
Machine vault Lock Make	S&G / Securrums / Hamilton / Others _____	
OTC feature Enabled in vault	YES / NO	
Connectivity Vendor(s)		
Dual Connectivity Type: Primary		
Dual Connectivity Type: Secondary		
Machine IP		
Gateway IP		
TMK Set No.		
Bank Detail		

Owner Branch:	Cash-link Branch
Address:	Address:
City:	City:
Pin code:	Pin code:
Contact Person (Branch: Mgr/Channel Mgr) Contact No.:	Contact Person (Branch: Mgr/Channel Mgr) Contact No.:
Email ID:	Email ID:
<b>Machine Details</b>	
Biometric Reader: Yes / No	
DVSS Camera (above screen): Yes / No	DVSS Camera (cash-slot): Yes / No
Operating System:	
Braille Keypad:	FDK present: Yes / NO
Hearing impaired friendly (talking ATM):	Languages: English (Y/N) Hindi (Y/N)
Touch Screen:	Regional Language (Y/N)
I have verified the above.	I have verified the above.
----- (Vendor Name, Signature, Seal)	----- (Bank Staff Signature)

Above certificate may revise by bank at any stage of this RFP / Contract period and may further include additional data requirement / confirmation from Vendor, during contract period.

#### **4.5.2 IMPLEMENTATION AND POST IMPLEMENTATION SUPPORT**

- 1) Vendor shall provide First Line Maintenance (FLM) including cash related faults and Second Line maintenance (SLM) for all machines, repair, spares replacements and maintenance service (response and resolution), round the clock throughout the year including Saturdays, Sundays and Holidays during the terms of contract on oral/ telephonic/ email/ SMS / Mobile Application or any other mode of communication by the Bank or through its own service personnel

or any service provider or any monitoring system through its own expert service resource wherever the ATMs are installed irrespective of number of physical visits at the site / endpoint and without any additional cost to the Bank. The service shall be made available by Vendor as under:

Category	Resolution Time/ TAT	Penalty
VIP ATMs	2 4 Hours: Irrespective of the population group/ category	<del>Rs 1,200/-</del> ₹500/- per endpoint per hour.
Regular ATMs	(i) 4 6 Hours: At Metro, Urban and Semi-urban locations (ii) 6 8 Hours: At Rural locations	Rs <del>1,000/-</del> ₹200/- per endpoint per hour.
The Bank has the discretion of classifying the ATMs as VIP or Regular subject to review.		

2) Endpoint Provider should ensure dispatch of qualified personnel to the endpoint site with a view to resolve the incident attributed to Endpoint Provider and operationalise the endpoint within the abovementioned resolution timelines under the following illustrative circumstances. Vendor shall follow following points and make necessary arrangements to make machine functioning: -

a. Vendor to arrange for Remedial Hardware Maintenance, at no cost to Bank:

- i. Vendor to arrange supply and replacement of spares, components, cassettes, devices etc. as well as labour required to repair a malfunctioning of endpoint caused due to any reason (including but not limited to flood, earthquake, natural calamities and vandalism cases, man handling, short circuit, fire, damage, voltage fluctuation, electrical malfunctioning, destruction, theft, burglary, sacking etc) and restore it to good operating condition without any additional cost to the Bank.
- ii. If any endpoint is beyond repair due to any reasons, it should be replaced with a new one within 30 days from the day when the machine is classified as beyond repair, without any cost to the bank, during the contract period and extension(s) thereof. However, the Vendor shall not link claim of insurance to the provisioning of services under this clause, to operationalize the endpoint. The replaced machines should be of the exact same or higher specifications which was provided to the Bank at the time of initial testing at Bank's ATM Lab. In case, bidders do not have the machines with the same specifications in all aspects, then the machine (with different specification, but not lower than the minimum specifications mentioned in this RFP) should be provided to the Bank's ATM lab for testing. The Bank's re-testing charges of Rs.20 lakh per machine should be borne by the bidder.

- iii. Remedial hardware maintenance includes software support (and software reload, OS Reload, MVS Reload, EPS Reload etc.) or CEN XFS reload. Further, it covers, inter-alia, free provision of spares, parts, kits, software, including CEN XFS, drivers etc., as and when necessary to ensure that endpoint functions in a trouble-free manner.
  - iv. Vendor shall correct any faults and failures caused due to any reason, in the equipment and shall repair and replace worn out defective parts of the endpoint as and when requested by the Bank. Unserviceable spares, components, devices of the endpoint caused due to any reason should be replaced free of cost by bidder within the aforesaid resolution time (if it affects / impacts the operation of the endpoint) and within two working days (if it does not impact the operation of Endpoint).
- b. Vendor to ensure Adequate spares, components and devices required for running the machine, should be stored and be made available at their offices' / godowns / warehouse, which are subject to Bank's verification at any time.
  - c. Vendor to ensure separate teams with adequate skilled manpower for handling FLM, SLM and cash loading activities to adhere the TAT stipulated by the Bank.
  - d. Services include releases and software code corrections for the current software version to support existing functionalities of the Equipment listed in Technical Specifications Appendix, wherever applicable, of the RFP which shall be provided and installed at all ATMs free of cost to the Bank and the last release of the prior software version for the Equipment should be preserved. All engineering changes generally adopted hereafter by the Endpoint Provider for equipment like that covered by this agreement, shall be made to the machine/equipment at no cost to the Bank. Qualified maintenance engineers totally familiar with the machines shall perform all repairs and maintenance service described herein.
  - e. Should fully support to resolve any issue / bug related to software / hardware / components / services / parameters / configuration / OS / XFS layer / devices / drivers / terminal diagnostic tools / utilities / patches / OEM Native Application provided by endpoint provider for smooth running of Solutions.
  - f. Any Certificate loading on the endpoint.
  - g. Replacement of Lock, hood keys, purge bin, currency cassettes and other plastic parts in the endpoint, Safe doors, endpoint safe, print heads, levers, pull the receipt roll, etc. without any cost to the bank.
  - h. Vendor to arrange for services like DNS (Domain Name System) setting, IP address changes, MAC address changes, Message Authentication Code changes, TLS changes, TMK changes, changing currency cassettes configuration, cassettes calibration, changing combination lock setting or any



other activities which cannot be performed by Centralized solutions as and when requested by Bank without any additional cost to the Bank.

- i. Vendor should ensure that any software / OS / patches / any change in Hardware introduced by them throughout the contract period, will be tested in coordination with MVS Vendor and approved by the Bank before it is deployed into production by Endpoint Provider.
- j. To provide the complete details with escalation matrix for reporting issues along with URL where the call is required to be logged. Vendor shall extend all support required by the Bank to integrate with Bank's 'Online Monitoring Solution (OMS)' and Mobile Apps when Bank requires integration. If Bank decides not to integrate, the vendor should use the Bank's Monitoring Tools (OMS, ESQ etc.). The Bank will provide login credentials to authorized personnel.
- k. To do root cause analysis for disputed / fraudulent transaction or any other case if bank may deemed fit, submit the report to the Bank within 72 hours of occurrence of such incident. Should extend full cooperation to Solution Provider / MVS Vendor / IT-ATM / any Dept. of Bank to isolate the issue whether it is software or hardware and work in close coordination to make the Endpoint up and running.
- l. Endpoints provider to share their respective product (Hardware (HW)/Software (SW)) roadmaps including software releases/updates to the Bank on a regular basis.
- m. Extend support for all changes related to calendar quarter are fully tested and ready for release by end of the calendar quarter and pilot at two endpoints.
- n. Bidder(s) shall arrange their own hardware, software and MIS (Keyboard, Mouse etc.) for day-to-day operation of ATMs if required by their custodians / engineers.

**o. Preventive Maintenance (PM):**

- i. Preventive Maintenance should be conducted once in a calendar quarter to ensure that the machines and allied equipment are maintained in good operating condition and the report should be submitted to the Controlling Office concerned. Preventive Maintenance may be scheduled at a time convenient i.e., it should not affect the customer service.
- ii. PM should be done to ensure that endpoint is maintained in good operating condition as per Equipment Specifications and includes the provision of labour, service parts as deemed necessary by Vendor and travelling time at no additional cost to Bank.

- iii. Vendor shall conduct preventive maintenance (including but not limited to inspection, testing, satisfactory execution of all diagnostics, cleaning and removal of dust and dirt from the interior and exterior of the endpoints and necessary repairing of the endpoints) at such intervals (minimum once in calendar quarter-{Please note that this will not restrict any other visit required for any other purpose at the endpoint by the Bank}) as may be necessary from time to time to ensure that the endpoint is in efficient running condition to ensure trouble free functioning.
- iv. Such visits could also be covered in visits for trouble shooting provided preventive maintenance is also done. Vendor should submit to the Bank a report as per requirement given in Online Portal **or** alternatively confirmed through the Web Portal. If required by Bank, Vendors should also use the Bank's Mobile App (of OMS) to fill the below checklist and submit it in the Mobile App. Access to Mobile App shall be provided to authorized personnel of the vendors. The vendor should invariably use Field call report (FCR) in Online monitoring System for uploading of preventive maintenance.
- v. PM should also be done for all the allied equipment like ACs, UPS, batteries with minimum 8 hours backup, eSS. Digital Signages etc. in the ATM Lobby once in every calendar quarter.
- vi. Vendor to ensure PM is done including the **below mentioned mandatory checks** (these checks can be updated from time to time as per bank requirement): -

<b>PREVENTIVE MAINTENANCE: ATM ID:</b>		
<b>SI</b>	<b>Check List</b>	<b>Done</b>
1	Verify the device logs and tallies to know the module performance	
2	Check endpoint Input Voltage i.e., Phase Vs Neutral Vs Earthing	
3	Verify all fans are operating correctly and are not noisy	
4	Ensure shutter assemblies and guides are fully tightened on to the fascia	
5	Using a vacuum cleaner, vacuum all internal surfaces including all modules	
6	Clean the vacuum filter, Replace if necessary	
7	Clean the LVDT sensor wheels with cotton buds and alcohol	
8	Check and replace the stacker wheels and gears if found damaged	
9	Replace all the gears and bearing using DPM kit	
10	Replace all suction cups and check and replace Pick line if found broken	
11	Ensure pick and presenter modules are aligned correctly (D wheel, Pick-Pick & Pick - Presenter)	
12	Ensure pick frame and cassette latches operate correctly and lock cassette into position	
13	Check purge bin micro switch; latch & shutter operates correctly	
14	Ensure presenter mouth is aligned to the safe door	
15	MCRW transport rollers should be cleaned with wet cloth	
16	Clean the card reader transport and head using the pre-soaked cleaning card	
17	Clean and align MCRW pre-head sensor, replace if required	
18	Check and adjust the shutter mechanism and align with fascia	
19	Check and clean all sensors in depository including anti-fishing sensor	
20	Clean the print head flex cable contacts and check the print head holder for proper operation	
21	Check the auxiliary transport drive gear meshes properly with the main transport drive gear	
22	Clean thermal print head and transport belts with wet cloth	
23	Clean EPP, Touch screen & FDK's with cloth dipped in IPA	
24	Ensure Mechanical lock dialer and reference plate are fixed and working properly	
25	Clean camera lens and mirror, Check USB cable are intact at both ends	

<b>PREVENTIVE MAINTENANCE: ATM ID:</b>		
<b>SI</b>	<b>Check List</b>	<b>Done</b>
26	Check cabinet lock, upper hood and door hinges, replace if required	
27	GBNA/GBRU Preventive maintenance as per Service manual	
28	Check and ensure that Cash retraction is disabled	
29	Grouting done or not done	
30	LAN Cables connection and concealment checked	
31	Air Conditioner in working condition	
32	Power Supply cleaned using brush or vacuum.	
33	Check Currency Cassette Pressure	
34	Cross Check the EndPoint is completely packed to avoid rodent entry	
35	Check and remove foreign material like paper roll, ribbon and unwanted paper bits	
36	Latest Software loaded. Mention the software version in the PM report	
37	Check for proper operationalization of combination lock	
<b>POST PM Check List</b>		
1	Card reader and receipt printer mouth aligned with fascia slot	
2	Align monitor display and calibrate touch screen	
3	Check dispenser shutter test in loop and ensure proper operation	
4	Do stack and clear test with 40 bills for multiple times, ensure dispenser work properly	
5	Run print alignment test for both printer and ensure for good quality print	
6	Check camera / DVSS for good quality images with transaction details imposed	
7	Ensure EJ setting and cash retraction patch work properly / EJ software is working properly	
8	Check card reader for track read and speed test, replace the module if required	
9	Clear tallies at end of the PM	
10	DVSS is working properly	
11	Environmental condition of EndPoint	Good /Bad

- p. Vendor to support for MVS / Security software etc. Testing of new OS (Windows-11 etc.), new XFS, any new change requiring complete MVS / Security software etc. Testing etc. should be without any cost to the Bank.
- q. During the entire Contract Period and extension thereof, any PC Core, hardware upgrade required (like RAM, hard disk etc.) would be without any cost to the Bank.
- r. Any other Bank's preventable calls.

- s. Endpoint is down for any reason.
- t. Clearing of currency jam, paper, card, journal / receipt paper jams, clearing of card jams. Repetitive cash jam issues general administrative maintenance (“Administrative Maintenance”), including retrieval of mutilated cash from the divert cassette.
- u. Visits required to bring the endpoint online when left in maintenance mode or to correct currency cassettes not properly seated; straps or bands not removed from currency; improper loading of currency into cassettes; or improper loading of cassettes into the endpoint; incorrect, or incorrect installation of consumable supplies; erroneous endpoint settlement totals causing the endpoint to go out of service; failure to clear the electronic journal.
- v. Endpoint down due to telephone line, Endpoint network, or any modem / connectivity equipment problems.
- w. Calls placed where no problems are found on arrival or problem auto-resolved.
- x. Visits to the site to allow access to Endpoint to a third party.
- y. Visits to the Endpoint because of vandalism, attempted theft or any incident to the Endpoint or site.
- z. Visits to the Endpoint because the Endpoint ran out of currency;
- aa. Calls resulting from Bank’s or third party’s erroneous actions.
- bb. ~~Endpoint Provider shall arrange to store DVSS footages up to a period of 180 days. DVSS images backup and EJ Backup as and when required by the Bank and during preventive maintenance shall be done by the Vendor without any additional cost to the Bank.~~ Bidder shall be responsible for availability of all cameras in working condition 24x7x365 as well as sufficient store space in HDD for storage for minimum 180 days. The responsibility of DVSS footages retrieving is of MVS vendor however, Bidder shall provide support to MVS team for retrieving of DVSS footage(s) and coordinate with them on regular basis.
- cc. Services for loading and on-going maintenance of encryption keys.
- dd. Services covers endpoint testing, installation, operationalization, reinstallation, upgradation, bug fixing, patches , resolution and troubleshooting the endpoint fault or its components or services or parameters or configuration or its accessories or software stack-OEM Native Application/MVS Application/EPS Application (which includes any agent provided by the Bank or OEM or Third party eg EJ agent etc) or any other specific activity/changes required by the Bank or of its representative,) with a view to ensure smooth functioning or its operationalization or to ensure proper reporting or to ensure the uptime or for regulatory requirement.

- ee. Trouble shooting of Software / Agents at the Endpoint for non-functioning of any of its functionality or Endpoint is down irrespective of facts whether it relates to Software or hardware breakdown. The Endpoint Provider will take full responsibility for ensuring that the Endpoint is functional with Solutions installed on the same and will aim for operationalization of endpoints and share the logs if required.
- ff. Upgradation of Solutions and its patches at the endpoints regularly from time to time or at regular frequency or because of any change in Solutions either through software distribution tool or through physical visits at endpoint in case the same could not be pushed through software distribution for any reason.
- gg. If required by Bank, Resolution of any issue related to Electronic Journal (EJ) at the endpoint.
- hh. If required by Bank, Resolution of any issue related to EJ Agent installed at the endpoint.
- ii. If required by Bank, Providing physical logs and / or camera (EJ/JP/IMAGE) from Endpoint in case of disputed / fraudulent transactions.
- jj. Extend support and ensure that all changes related to calendar quarter are fully tested and ready for release by end of the calendar quarter and pilot at two ATMs and distribute the same to the ATMs remotely if bandwidth permits else through the engineers for manual installation and operationalization at the endpoints.
- kk. To test Bank's Provided agent (s) at Lab and roll-out (i.e., install at all endpoints) after pilot at two live Machines at respective model remotely if bandwidth permits else through the engineers for manual installation and operationalization at the endpoints.
- ll. If Endpoints provider believes that there is a deficiency in the Solutions that materially impacts the loading, configuration or operation of the Solutions for the Bank, Service Providers to follow the escalation matrix, its process, Service Request format, problem severity, service level definition, means of communication etc. (to be finalised at the time of execution of agreement). Endpoints provider's personnel are authorised to produce trace logs in the manner required by Solution Provider, copy trace log files onto the media and to dispatch expeditiously through fastest means of communications to Solution Provider for analysis and its solution. The trace log files from the application Solutions are and shall remain the property of Solutions but are subject to rights of the Bank. Endpoint provider or any of his representative will not disclose trace log files from the application Solutions to anyone other than the Bank and Solution Provider. It is further understood that non-Solutions event logs, such as general event log files in Windows, are not Solution Provider confidential information or restricted in any manner. Endpoints providers are authorised to produce documentation that shows how to configure, install and operate the Solutions that includes reproductions of graphical outputs from the ATMs produced by the

Solutions, and to reproduce and distribute such documentation to Endpoints Provider's representatives who perform services to the Bank.

- mm. Immediate support and work closely with solution provider eg : Bug fix, customisation, modification, enhancement related to regulatory or causing the financial loss to the Bank or affecting the Bank's reputation or the Bank terms it as critical, for its quick release.
- nn. Endpoint provider should provide all the Firmware / Software updates as and when they are released. Along with Firmware / Software updates, the procedure & utilities for firmware updates should be shared with the Bank and Solution Provider. Endpoint provider will demonstrate this activity of firmware / software update to the representative of Service Provider at the Endpoint supplied to Bank for UAT environment. A complete procedure of firmware / software rollback should be provided upfront so that firmware / software can be rolled back to previous version in case of any issue while doing firmware / software upgrade.
- oo. **In-built Digital Video Surveillance System (DVSS):**
  - (a) At the time of preventive maintenance services, check if image is captured correctly;
  - (b) Using VENDOR VSS menu under supervisor mode to check that images captured are getting stored in the hard disk drive of ATMs;
  - (c) checking camera status, image capturing and data storage at every preventive maintenance of ATMs;
  - (d) Digital VSS hardware and software maintenance – In the event of failure, take appropriate actions to rectify the same:
  - (e) Change of cable if bad
  - (f) Change of camera if bad
  - (g) Change of HDD if bad
  - (h) Reload s/w in case of s/w crash or change of HDD
  - (i) With submission of AMC bill for payment, a copy of DVSS image along with others required documents is must as a proof of doing the preventive maintenance of DVSS.

#### **4.5.3 ACCESS SECURITY AND LIABILITY:**

It is agreed that Vendor shall perform Service at the Endpoints without any employee or agent of Bank being present to provide security for the cash and Valuables contained in the Endpoints and at Endpoint site.

#### **4.5.4 REPLENISHMENT OF CONSUMABLES:**

- 1 Vendor to supply and replenish consumables such as paper roll, printer ribbons, Vendor shall replenish inkjet cartridge, essential consumables to ensure uninterrupted ENDPOINT operation as necessary without limitation on quantity.
- 2 The specification of these consumables shall be as under:

- a. Ribbons of high tensile strength material – 12.7mm with 24' length. shall
  - b. print 5 million characters approx., if applicable.
  - c. Receipt Rolls – 80mm wide x 8" dia approx x 0.7" core dia produced on ENDPOINT grade thermal paper Appleton Alpha 8. The density of sense mark shall be uniform with 1.2 plus & tolerance level of slitting shall be +/- 0.012".
  - d. Any artwork / writeups, as and when required, at the back of the receipt paper rolls by the Bank should be implemented without any additional cost to the Bank during the entire contract period and extension(s) thereof. The artwork / writeups can be in colour or Black & White or greyscale.
- 3 Consumable Management shall be independent of ENDPOINT make, model, type of network & Vendor.
- 4 Stationery, other than specified in this RFP, if required to be procured & implemented in future, shall be contracted at mutually agreed terms.

#### **4.5.5 MANAGEMENT CENTRE ACTIVITIES:**

The Vendor should be capable to handle the allotted quantities of Machines for providing the said Services under the contract immediately. They should also have a clear action plan to ramp it up to handle number of machines. The responsibility of collecting all the required information and customization to communicate with the Circles shall be with the vendor and must be carried out by the vendor without any additional cost to the Bank. The cost of leased line and back up connectivity from the Vendor's Management Centre and DR Site to the Bank's Switch and DR Site must be borne by the Vendor, if such connectivity is required. The recurring expenditure relating to such connectivity shall be borne by the Vendor. Cost of licenses / software / hardware / services required to provide Managed Services will be borne by the Vendor.

##### **A. Event / Incident Management Services:**

Vendor shall remotely monitor Bank's networked endpoints allotted to Vendor, both proactively and reactively, for any type of performance issues and shall rectify them as per the specified TAT in this RFP.

##### **B. Monitoring and ensuring improved uptime / availability:**

Receipt of service requests via a helpline number (Toll Free Number -----) to Vendor's Management Centre or as per the trouble ticket generated in the monitoring system/ Bank's Online Monitoring Solution (OMS)/ ATMMON.

##### **C. Remote Monitoring:**

- i. Remotely poll devices at intervals that detect problems immediately on occurrence.
- ii. Detect events that exceed set thresholds.
- iii. Use Simple Network Management Protocol (SNMP) for polling, wherever SNMP cards are provided for UPS and necessary feed is received.



- iv. Use reliable, dedicated IP connection with backup.
- v. Endpoint/ATM cash forecasting. Daily order recommendation
- vi. Potential cash out/cash full warning for endpoint
- vii. Centralized monitoring and control over access to endpoint and safes

**D. Fault Identification – remote diagnostic tools to be used (Bank’s OMS)**

- i. Notify appropriate agency for activating support.
- ii. Notify customer at detection, isolation and resolution.
- iii. Manage incident from detection to resolution.
- iv. Performance Management:
- v. Proactive / predictive analysis & recommendations.
- vi. Setting event thresholds based on customer availability needs.
- vii. Tuning performance by correlating events with performance metrics.
- viii. Order to identify bottlenecks that inhibit availability and performance.
- ix. Automate collection of key performance metrics.
- x. Normal functioning of DVSS based on the feed from ATM/Bank’s.

**E. Inventory Management:**

- i. Create and maintain inventory of devices / equipment (like ACs, UPS, Batteries, Lights, Notice Boards, eSS, Signages etc.) and their configurations present at a Site.
- ii. Software and screen distribution from a central source whenever eJ pulling service is availed by Bank.
- iii. Components of the machine (like Processor, RAM, OS Version with Service pack details, OTC lock / vault, Card reader, Biometric readers, contactless reader, DVSS cameras etc.) with their type / version numbers / manufacturing dates and their software versions.

**F. Reporting:**

- i. Show open and closed incident status at secured website.
- ii. Update Vendor’s customer help desk about estimated service restoration time.
- iii. Monthly report on fault, performance and configuration metrics.
- iv. Interpret metrics and make recommendations for improvement.
- v. Consolidation of settlement and reconciliation reports.

**G. Service levels:**

- i. 24 x 7 x 365 days monitoring and resolution.
- ii. Unlimited incidents and physical visits whenever required.
- iii. Toll free number with multiple lines for service requests (minimum 100 lines).

**H. Response Time**

- i. Intimation to Bank within 3 minutes of fault occurrence.
- ii. Initiation of remedial action within 3 minutes from occurrence.
- iii. Endpoint availability shall be measured using Banks’ Online Monitoring Tool for which an access shall be provided to Vendor. Bank shall provide

to Vendor web login access to Banks' monitoring solution to check the ATM status online.

- iv. Bank may, at its discretion, integrate Bank's Online Monitoring Tool with the Vendors' Incident Management System through Rest API based WEB Services. Vendor shall take corrective action on the basis of information displayed in the Banks' Online Monitoring Tool, if there is a case in which the Vendor's system has not captured certain faults.
- v. Vendor shall attend to tickets raised by mobile application / e-surveillance system / any other system as approved by the Bank from time to time.

**I. Availability of endpoints:**

Helpdesk shall act immediately on the tickets raised by mobile application / e-surveillance system / any other online system as approved by the Bank from time to time.

- i. The Selected bidder shall maintain the target availability at all levels as stipulated by the Bank in subsequent paragraphs.
- ii. ENDPPOINT availability will be measured using Banks' Monitoring System for which an access will be provided to Management Support Centre Helpdesk team.
- iii. Online Monitoring Tool - web login access will be extended to the successful bidders to check the endpoint status online. Successful bidders should take corrective action on the basis of information displayed in the Online Monitoring Tool.
- iv. The Vendor shall maintain raw availability as calculated by Bank's monitoring solution at each Circle level separately. The monthly availability report published by Endpoints/ATM monitoring solution shall be considered for above purpose.
- v. The Vendor shall maintain availability at individual Endpoint level as well as for the entire channel. For this purpose, 'channel' will include total number of Endpoints in a Circle.
- vi. All machines/endpoints of the Bank will be categorized in 2 types and maintain the availability mentioned there against:

Category	Minimum targeted Uptime/Availability per month
VIP-endpoints	98 %
Regular endpoints	96% 95%

- vii. There shall be no exclusion to availability, except force majeure cases like flood, earthquake, natural calamities and vandalism cases etc. as mentioned under the "Force Majeure" clause of this RFP.

**J. Central Helpdesk at Management Centre:**

Vendor's help desk function (available 24 x 7 x 365) shall be the single point of contact for engineer's phoning for help, wanting feedback on the status of a problem or managing multiple parties to resolve problems.

The Helpdesk services will broadly cover the following illustrative list but not exhaustive:

- i. Vendor shall provide Managed Services which would include round the Clock Centralized remote monitoring with all related field-level support services in respect of endpoints.
- ii. Vendor should ensure their key personnel with relevant skill are always available at the Management Centre and ensure the professional standard, quality and delivery of services. Sufficient number (as required by Bank) of Key personnel(s) with relevant skill & experience should be posted at the Bank's Offices (Corporate Center, GITC, LHOs, RBOs, AOs etc.) for co-ordination etc., as and when required by the Bank, without any additional cost to the Bank. The vendor should provide the key personnel(s) with necessary IT infrastructure (Laptop, internet connectivity etc.), without any additional cost to the Bank.
- iii. Vendor's support staff should be well trained to effectively handle queries raised by the Bank customer / employees / service providers etc.
- iv. The expected time of resolution should be average 3 minutes per call which are of routine nature.
- v. Help Desk with Toll free telephone number with multiple lines (minimum 100) (24 x 7 x 365 days a year) as single point of contact for endpoint issues and manual lodging of issue in the Incident Management Ticketing available in Monitoring System on receipt of requests over toll free number. Single Point of Contact for engineer's phoning for help, wanting feedback on the status of a problem or managing multiple parties to resolve problems. Receive telephone call from external customer, identify the caller, log and create the incident ticket and assign the incident priority.
- vi. Receive telephone call from external customer, identify the caller, log and create the incident ticket and assign the incident priority.
- vii. Browser-based solution to enable branches to log incidents and track resolutions.
- viii. Supplemental support for variations in business patterns.
- ix. Automatic escalation tools and procedures.
- x. Customized report options.
- xi. Proactive problem resolutions.
- xii. Coordination / management of multi-Vendor support.

- xiii. Round-the-clock remote support to all field engineers and customers in India.
- xiv. Vendor shall provide the required documents to the Bank's official.
- xv. Toll free telephone number with multiple lines (minimum 100)
- xvi. Vendor shall display the contact number for any support.
- xvii. Must be the single point of contact with multiple lines for Bank for help, checks on status of endpoint problem, endpoint / endpoint equipment problems, managing multiple parties/resources for Testing, installation, operationalization, reinstallation, upgradation, bug fixing, resolution of any issue and troubleshooting the endpoint or its components or its accessories or software stack (which includes any agent eg Multi-Vendor Software Agent, endpoint protection solution agent(s), EJ agent or agent provided by the Bank etc) with a view to ensure smooth functioning or its operationalization or to ensure proper reporting or to ensure the uptime or any other specific activity required by the Bank as per RFP.
- xviii. Escalation process should be in place for unresolved issues.
- xix. Considering expected number of calls which depends upon the knowledge gap about the solution / defects in the solution / suggestion for improvement etc, the help desk should be manned adequately with dedicated resource for the same.
- xx. Selected Bidder must provide with a dedicated and exclusive team at the Management Centre
- xxi. Maintenance of up-to-date documentation on SOP for day-to-day activities,
- xxii. Providing on the call support to provide the One-Time-Password to service provider at the endpoint site using the Centralized Access Management Solution after ensuring the legitimacy of the service provider from the Inventory.

**K. Management and Administration of Help Desk:**

- i. **Managing Vendor and Third-Party Service Providers / Sub-contracted vendors:** Endpoint provider is accountable for managing the coordination of incidents that required both single and multiple party dispatches. The Endpoint Provider's responsibility is to automatically /

immediately escalate an incident call to respective vendors / service providers for all equipment / services, and to track all incidents at periodical intervals to enable that the error is rectified within reasonable time.

- ii. All incidents which are auto-logged / manually logged under the Incident Management System should be followed up till resolution of problems.
- iii. Based on Incident Management System manage the coordination of incidents that require both single and multiple third-party dispatches. Vendor shall monitor (i) receipt of an incident, (ii) arrival on-site, (iii) repair time and (iv) total resolution time from start to finish.
- iv. In case of communication error, Vendor shall take up with the connectivity Provider entity immediately and follow up rigorously till the fault is rectified.
- v. Based on the Online portal made available as required under RFP for auto-generation / reporting of tickets / faults at the endpoint, Vendor as a part of warranty, immediately arrange for dispatch of skilled personnel and ensure to resolve the faults within the stipulated resolution time.
- vi. Monitoring the status of endpoints for non-compliance of Multi-Vendor Software and Endpoint Protection Solution (will require coordination with various vendors).
- vii. Proactive and reactive review of hardware performance and service providers' performance in relation to SLAs.
- viii. Proactive problem resolutions.
- ix. Supplemental support for variations in business patterns.
- x. Scheduled Maintenance Jobs.
- xi. Use of data analysts for improving uptime of endpoint and its implementation. Assistance in meaningful analysis of performance for improving uptime and availability of endpoints.
- xii. Providing various reports detailing performance of the network on pre-agreed criteria.

**L. Dispatch Requests:**

Vendor Incident Management System shall take error codes from the machines and route these codes to its dispatch system or a Vendor ATM Management Centre agent or the appropriate service provider as designated by Bank. All incidents which are auto logged / manually logged under the Incident Management System should be followed up till resolution of problems. In case of communication error, Vendor shall take up with the connectivity Service Provider immediately and follow up rigorously till the fault is rectified.

**M. Modules:**

If required by Bank, the Vendor will integrate with the Bank, for the feed distribution system for Online Monitoring Solution (OMS) / Switch based Monitoring Tool of the Bank. The Vendor will be provided web access of OMS / Switch based Monitoring Tool for Operational Dashboard / Fault Monitoring, Ticketing & Incident Management Module, and Vendor Payment System.

**N. Managing Vendor and Third-Party Service Providers:**

Vendor's Incident Management Service manages the coordination of incidents that require both single and multiple third-party dispatches. Vendor shall monitor (i) receipt of an incident, (ii) arrival on-site, (iii) repair time and (iv) total resolution time from start to finish.

**O. Reporting:**

- i. Vendor Management Centre shall notify the closure of incident to the linked branch and shall provide Bank monthly report on Endpoint / ATM channel performance.
- ii. Endpoint / ATM messages triggered upon crossing of threshold, thermal or vibration captured by the Switch shall be passed on to the Vendor's Management Centre who shall trigger appropriate escalation/alarm. At sites configured with hooters / alarms, the crossing of these thresholds shall also trigger such local alarms / hooters also provided the feed from the Switch is received and appropriate mechanism exists.
- iii. Escalation shall be necessary for other defined events, like supervisory activity in a particular period of the night.

**P. Performance Reviews:**

Vendor shall conduct monthly performance reviews with Bank at LHOs and Corporate Centre at mutually agreed schedules, dates and locations and representatives from both Bank and Vendor shall attend such performance reviews. Meeting agenda items shall include, but not be limited to, Downtime statistics, service levels, missed problems etc.

**Q. Bank's Responsibilities:**

- i. **Network Access:** Bank shall, if deemed necessary, provide Vendor access to Bank's network. This shall be a dedicated link from the Vendor ATM Management Centre to Bank's ATM network, adhering to the Network security requirements mentioned in the Connectivity Section of this RFP.
- ii. **Bank's Management Interface:** Bank shall communicate with Vendor personnel through a specific set of contacts for initial call placement. Name and phone numbers (during office hours and after office hours) of individuals responsible for assisting Vendor shall be provided prior to the Implementation Date.

**4.5.6 CENTRAL HELP DESK FOR ATM FAULT REPORTING AND QUERIES**

- i. Vendor should provide a help desk that provides single point of contact manned by expert personnel for all service teams / managing multiple parties involved in resolving ATM uptime related problems.
- ii. The Central help desk should be customized to cater to the Bank's requirements, which eliminates any process duplication. In addition, the successful bidder would be expected to have a service centre with dedicated telephone number in each of the districts in the geography for which they are implementing the contract.
- iii. Vendor should install a dedicated telephone number with multiple lines to support the load of incoming calls without rejection and receive all service requests via that number.
- iv. Vendor should ensure the highest level of availability of each Endpoint terminal and entire Endpoint/ATM Network through Help Desk Services.
- v. Single, integrated view of the network of the Endpoints should be provided by Vendor to know the status of each Endpoint. Any discrepancy noticed must be rectified immediately in coordination with switch vendor and any third-party vendor involved.
- vi. A web-based / app application with reporting tool should be made available to the Bank's ATM Dept. for monitoring performance of the ATM network.
- vii. The Vendor should maintain complete confidentiality in the matters related to Endpoint as they deal with the financial / customer data pertaining to the Bank.

**4.5.7 FIRST LINE MAINTENANCE (FLM) SERVICES**

The Vendor should have dedicated separate FLM team from CRA / CIT Agencies and attend to the following matters (including but not limited to) as standard FLM Services calls:

- i. Clearing Paper Jam of Receipt Printer roll
- ii. Removal or clearing of currency jams and captured cards.
- iii. Supply and Replenishment of consumables such as Receipt paper, etc. without any quantitative limit
- iv. Site maintenance, maintaining environmental conditions ~~etc. and cleaning work~~ as mentioned above in Scope of Work.
- v. Machine resets, CIT caused errors and other reasonable requests.
- vi. Replacement of defective LAN cables
- vii. Connectivity and power issues,
- viii. Taking backup of camera image(s) / ~~footage(s)~~ (of all cameras mentioned in Technical Specifications) ~~as and when Software upload / reload, upgradation etc. shall be done by the bidder. on monthly basis on a suitable backup media and handing over the same to the controlling office.~~
- ix. Maintaining proper register of the backup taken for DVSS with acknowledgement from Controlling Office and handover of backup, ~~if any~~ to Controlling Office.
- x. Vendor under FLM services should replenish the consumable like paper for receipt printer and printer ribbon without any quantitative limit.
- xi. If Thermal Paper used for Receipt, it should have the quality to retain the print at least for one year period.
- xii. any other fault requiring FLM to ensure machine fault is resolved and made available for customer transactions.
- xiii. FLM calls related to bottom hatch of the Endpoint that requires opening of Endpoint safe / vault shall be attended by Vendor appointed CIT.
- xiv. Vendor should provide FLM services on 24 X 7 X 365 basis.
- xv. Vendor shall attend any other time to time instructions as advised by the Bank during contract period.

#### **4.5.8 CASH REPLENISHMENT / CASH EVACUATION SERVICES:**



- i. While Vendor may engage “Cash-in-Transit (CIT) / Cash Replenishment (CRA) / Cash Evacuation” agencies as per norms / parameters set by the Bank in **Annexure-1** for this purpose, Vendor alone shall be accountable to the Bank and responsible for mandatory Service Level Agreement (SLA). The Vendor shall be wholly responsible for meticulous compliance by CIT agency of stipulations as given in the Agreement. All pecuniary liabilities arising out of Cash Related Services shall be to the account of the Vendor.
- ii. The Vendor shall comply with Bank’s instructions in this regard from time to time. The Cash related activities shall include, inter alia, receiving / depositing cash from a designated Centre / Branch of the Bank / Reserve Bank of India (in case of strike in Banking sector except in RBI / Natural calamities) and replenishing the same in endpoint on the same day (in case: vaulting not permitted / vaults not available), performing “End of Day” (EOD) functions at site and furnishing detailed MIS as required by the Bank.
- iii. The Vendor shall be responsible for reconciliation of cash and resolution of all complaints related to ADMIN transactions at the ENDPOINT and Vault end. In this regard, vendor shall adhere to the instructions issued by the Bank from time to time in the interest of the Bank, latest instructions issued by RBI vide its letter No. RBI/2018-19/183 DCM(Plg) No. 2746/10.25.07/2018-19 dated May 14, 2019 and MHA Guidelines for CRAs dated 8<sup>th</sup> Aug 2018.
- iv. Transit Loss liability for the Vendor will be the total amount given by the Bank to the vendor or to the CIT agencies engaged by them.
- v. Vault Loss liability for the Vendor will be the total amount given by the Bank to the vendor or to the CIT agencies engaged by them less the amount actually replenished out of that total amount plus the amount actually evacuated, if any.
- vi. Captioned services will be availed at the endpoints located anywhere in India at the discretion of the Bank.
- vii. The following RBI / GoI Guidelines and any other guidelines issued in this regard, related to Cash Management Activities must be adhered to (illustrative but not exhaustive):
  - A. RBI **DCR.No.BP.BC.76/21.04.158/2014-15 dated March 11,2015 - Guidelines on Managing Risks and Code of Conduct in Outsourcing of Financial Services by Banks.**

- B. RBI/2017-18/ 152 dated 06.04.2018: (Cash Management activities of the Banks- Standards for engaging the Service Provider and its sub-contractor)
- C. RBI -DCM No. 2746/10.25.07/2018-19 dated May 14, 2019- Reconciliation of transactions shall be done between the bank, the service provider and its sub-contractors at least on a T+3 basis
- D. Gazette Notification issued by Ministry of Home Affairs (MHA), New Delhi on 8th Aug. 2018
- E. RBI Cash out Penalty: RBI/2021-22/84 – DCM (RMMT) No. S153/11.01.01/2021-22 dated 10.08.2021.

viii. Refer the below Cash Appendix in this RFP for detailed scope of Cash Services.

#### **4.5.9 CASH APPENDIX:**

If a conflict exists between the terms and conditions of any clause of this RFP and this Cash Appendix, the order of precedence shall be (a) this Cash Appendix; and (b) any clause of this RFP.

##### **4.5.9.1 DEFINITIONS:**

As used herein, the following terms shall have the following meanings:

- i. **“ATM Loss”** shall have the same meaning as defined in the Definitions in this RFP.
- ii. **“ATM Loss Liability Limit** shall have the same meaning as defined in “Managed services for Endpoints” in the scope of work.
- iii. **“Initial Currency Load”** means the first currency load for a new ATM installed or conversion. Initial Currency Loads must be scheduled at least 2 weeks in advance.
- iv. **“Scheduled Cash Replenishment Services”** or **“Cash Replenishment Services”** are scheduled cash replenishments that are performed in adherence to a replenishment schedule that is recommended in indents raised by Vendor.
- v. **“Unscheduled Replenishment Services”** means Cash Replenishment prior to or post the scheduled replenishment to prevent depletion of currency level in the ATM.

- vi. **“Cash Evacuation Services”** means cash removed / evacuated from the ATMs and deposited in the Bank’s Branches.
- vii. **“Transit Loss”** means a single occurrence of the loss of Valuables from a vehicle owned, operated by, or under the control of Vendor’s designated subcontractor.
- viii. **“Transit Loss Liability Limit”** means maximum liability for a single Transit Loss Liability Limit as per MHA guidelines, which is currently at Rs. 5 Crore/- (per transit) or the actual outstanding amount of the Bank, whichever is higher.
- ix. **“Vault Loss”** means a single occurrence of the loss of Valuables from a vault or other secured facility owned, operated by, or under the control of Vendor’s designated subcontractor.
- x. **“Vault Loss Liability Limit”** means Vendor’s maximum liability for a single Vault Loss Liability Limit is Rs. 10 Crore/- (per vault) or the actual outstanding amount of the Bank, whichever is higher.
- xi. **“Currency”** means currency notes / banknotes and **“Valuables”** means Currency and, only to the extent Bank and Vendor have agreed in writing, other identified types of negotiable instruments or items of value.
- xii. **“CRA / CIT Agencies / CIT”** means Cash Replenishment Agencies / Cash-in-Transit Agencies who have been engaged for the cash replenishment in machines & cash evacuation from the machines as specified in the Cash Appendix of this RFP.

#### **4.5.9.2 TERM:**

The term of this Cash Appendix shall continue till the validity of the Agreement and extension thereof.

#### **4.5.9.3 COMMENCEMENT OF SERVICES:**

**“Commencement of Services”** shall mean the date on which the newly commissioned machine under this RFP is made **“cash-live”** and available for customer cash transactions. **“Cash-live”** means that the cash has been replenished in the machine and ATM performs cash withdrawal transactions successfully.

#### **4.5.9.4 SCOPE OF SERVICES:**

- i. Bank and Vendor have agreed that Vendor shall provide Cash Replenishment / Cash evacuation Services, or through “cash in transit” subcontractors (the “CIT”)

as per Bank / RBI / MHA / Gol or any other statutory bodies' Guidelines, subject to written approval from bank for such subcontracting. The Vendor shall provide Cash replenishment / Cash evacuation services at every endpoint allocated to the vendor. Bank expressly acknowledges that:

- a. Vendor may subcontract the responsibility for the Cash Replenishment / Cash Evacuation Services to the CIT agency, subject to written approval from Bank for such subcontracting and submission of SLA with Subcontracted agency(es);
  - b. Vendor has identified & verified the CIT agency(ies) as per the extant Guidelines and submitted the necessary documents to the Bank;
  - c. **Subject to compliance of point (a) & (b) above**, Bank may accept and may not object to the appointment of the CIT, if it is as per the norms / parameters set by RBI / MHA / Gol / or any other statutory bodies / Bank as mentioned in **Annexure-1**.
- ii. Vendor shall manage and report all cash placements, store spare currency for Scheduled and Unscheduled Replenishments, in the manner, frequency and amounts mutually agreed with Bank.
  - iii. Bank shall provide the required sorted cash of ATM-fit notes to the CIT. Cash indents shall be submitted at cash link branches adequately in advance. Cash is to be issued by Bank from one or more designated branch in each city identified for this purpose. In case of emergency, Bank may direct CRA to collect cash from any other Branch / any other Private or Public Sector Bank / RBI Offices in the city. Vendor shall submit to Bank's designated branch a list of CIT's authorized signatories to sign withdrawal slip; and CIT's authorized operation staff.
  - iv. CIT shall withdraw cash from designated branch against Cash Withdrawal Requisition Slip / Cash withdrawal request as per format mentioned in **Annexure-2** to this Cash Appendix and supporting documents i.e. Vendor Cash indent / Schedule Cash order as per format mentioned in **Annexure-3** to this Cash Appendix, Current Account cheque signed by authorized signatories of CIT. Cash indents shall be submitted to the Bank designated branch (Nodal Branch) via E-mail / fax or any other mode as defined by Bank to facilitate them to arrange delivery of cash.
  - v. Vendor shall submit Board approved **Business Continuity Plan (BCP) / Disaster Recovery Plan (DRP)** initially and as and when required by the Bank, for Cash Replenishment / Evacuation services acceptable to the Bank.

- vi. Depending upon geography / routes / number of endpoints linked to a particular branch, Vendor shall transport the cash meant for SBI in a dedicated carrier van.
- vii. Vendor shall ensure that CIT / CRA replenish / evacuate the cash at the endpoints on the "T" day as per vaulting / non-vaulting guidelines mentioned in this RFP.
- viii. Vendor / CIT shall allow Bank, its authorized representatives, RBI and other regulatory & statutory bodies to conduct vault audits at location where currency vaulting services is provided. Audits shall be conducted by Bank at its own cost during normal business hours. Bank representatives shall carry a letter authorizing them to conduct such audits along with their identity cards, any Bank official without the said authority letter and identity cards shall not be allowed by CIT to conduct audits.
- ix. **Administrative Maintenance:** ~~The CRA / CIT of the Vendor shall conduct EOD activity on ATM on daily basis and submit necessary reports. At the time of daily end of day activity, CIT shall retrieve and account for mutilated cash from the divert cassette; replenish receipt tapes, ribbons and print cartridges, if required. The CRA / CIT of the Vendor shall conduct End of Day (EOD) activity on ATM on regular basis, at least on alternate day (minimum 15 days in a month) and submit necessary reports and excess cash, if any, on same day but not later than T+1 day. At the time of EOD activity, CIT shall retrieve and account for mutilated cash from the divert cassette; replenish receipt tapes, ribbons and print cartridges, if required. EOD shall be done on same day as and when Bank demands, without any cost to the Bank.~~
- x. **ATM Balancing:** At the time of daily end of day activity CIT shall reconcile physical cash in the Endpoint, ATM cassettes and in the purge bin (reject bin) etc. with the ADMIN balance (end cash shown denomination wise in ADMIN slip) and BGL account 3198 of respective Endpoint. The CIT shall not zeroize the counter. Balancing receipts shall be returned to Bank next day. The CRA / CIT shall perform ADMIN activities at Endpoint as directed by the Bank.
- xi. ~~CIT shall use secured cash van as per the specifications given in Annexure-1. The CRA / CIT shall ensure that cash shall always be in joint custody of two persons and single individual is not allowed to handle cash at any time. Further, security guards shall be in each vehicle for transportation of cash safely and efficiently as per RBI / MHA Guidelines.~~
- xii. ~~If the Bank provides a generic tool for monitoring of movement of cash the Vendor shall integrate it with their system without any additional cost to the Bank.~~

#### **4.5.9.4.1 CASSETTE SWAP SERVICES**

- i. Cash Replenishment Services through Cassette Swap Method ab-initio **and without any cost to the Bank**: Detailed process of Cassette Swap Method shall be shared with Successful bidder later on **and it shall be binding to successful bidder**.
- ii. Cassette swap Method is mandatory ab-initio to follow by successful bidders. Vendors to replenish/evacuate cash through Cassette Swap Method in terms of RBI's notification No.RBI/2017-18/162DCM(Plg.), No. 3641/10.25.007/2017-18 dated 12<sup>th</sup> April 2018, RBI/2021-22/71 DCM (Plg.) No. S39/10.25.007/2021-22 dated 12<sup>th</sup> July 2021 and RBI/2021-22/190 DCM (Plg.) No. S 1117/10.25.007/2021-22 dated 31<sup>st</sup> March 2022 etc.
- iii. In case of noncompliance of specifications of lockable cassettes as per RBI notifications, penalty as stipulated by RBI from time to time and as decided by the Bank (as per appendix-I or anywhere in this RFP) will be imposed on the erring vendors.
- iv. Successful Bidder, at its own cost, should arrange for additional set of lockable cassettes and lockable reject / retract / counterfeit bins for implementation of Cassette Swap Method (mandatory ab-initio) including replacement of faulty lockable cassettes, of cash replenishment / evacuation in each endpoint during the contract period and extension thereof. Further, vendor will replenish/evacuate the cassettes at its own premises and at its own risk and responsibility. The bank will not be liable for any loss arising in this regard.
- v. The non-working / worn-out cassettes will be replaced with new ones by the vendor as and when required, without any cost to the bank.
- vi. The penalty instructions vide RBI notification no RBI/2021-22/84 DCM (RMMT) No. S153/11.01.01/2021-22 August 10, 2021 for Cash out ATMs will be implemented for banks/ White Label ATM Operators (WLAOs) to avoid cash-outs. Any non-compliance in this regard shall attract monetary penalty as stipulated in the "Scheme of Penalty for non-replenishment of ATMs".

#### **4.5.9.4.2 Cash Replenishment / Cash Evacuation:**

- i. The Successful Bidder/ its appointed CRA/CIT to use the "Cassette Swap" Method ab-initio for Cash replenishment as advised by RBI. Successful bidders shall fulfil all statutory requirement in this regard at their own cost.

- ii. The Vendor shall ensure that the entire cash handed over by the Bank is replenished in the ATMs by end of the day against which it had been provided. Reconciliation in this regard must be done on T+1 calendar day basis (where T is the replenishment day), in case of vaulting facility is extended to vendor and/ or on T+0 basis, in case no vaulting facility is extended to Vendor. In any case the cash must reconcile by depositing in Branches on T+1 calendar day basis, failing which an interest @ clean overdraft rate prevalent at the material time will be recovered from the vendor ~~along with the penalty of Rs 5000/-~~ per instance.
- iii. In each Endpoint, replenishment / Evacuation of cash shall ordinarily be done once a day. In case the number of cash replenishment / evacuation is less than 15 days in a month, penalty @ Rs. 1,500/- for each day default for non-compliance of cash replenishment shall be imposed. This penalty shall be in addition to Cash out and other penalties as prescribed elsewhere in this RFP. However, Bank reserves the right to increase the number of Cash replenishment / Cash Evacuation days in a month at its sole discretion, as and when required, without any additional cost to the Bank.
- iv. If due to any reason e.g., unexpected high withdrawals, subsequent loading(s) in a day is / are required, Vendor should arrange for such replenishment activity (ies) immediately, without any cost to the Bank.
- v. The cash replenishment activity shall be conducted by the joint custodians at the Endpoints.
- vi. The Vendor shall ensure that no cash out in Endpoints due to delay in the replenishment on their part.

#### **4.5.9.4.3 COMPLIANCE OF STATUTORY AND OTHER RESPONSIBILITY: -**

- i. The Vendor should ensure that existing and time to time issued statutory, regulatory and all other guidelines are complied during the contract period and extension thereof, with respect to the cash-in-transit, cash held in vaults and cash loaded or cash evacuated in / from ATM.
- ii. It shall be the sole responsibility of the Vendor to obtain required licences, permissions etc. from local or any other authority for cash transit or vaulting.
- iii. Any penalty charged to the Bank for non-compliance with any guideline or for non-obtainment of required permissions, licenses by the Vendor will be reimbursed by the Vendor to the bank.

- iv. In the event of seizure of Bank's cash for non-compliance of any guidelines or non-obtainment of required licenses, permissions etc by the Vendor, all costs incurred for release of bank's cash will be borne by the Vendor.

#### **4.5.9.4.4 CURRENCY VAULTING SERVICES: -**

##### **A. Daily Overnight Vaulting Facility (T-1 Vaulting):**

- i. The bank shall permit daily overnight cash vaulting wherever vaults are available. Vaults should be as per Bank / RBI / MHA guidelines.
- ii. T is the replenishment day.
- iii. With this arrangement, the replenishment of cash in Endpoints can begin at early morning hours by providing cash to vendors 1 day prior (T-1) to replenishing day (T) at the centres where Vaulting Facility is permitted. The vendor will share the ATM wise, denomination-wise indent on T-2 days to the respective Currency Chest / Cash-linked Branches of the Endpoints as per the cash dispensation pattern of the respective ATMs.
- iv. After going through the indents, the branch shall advise the vendor its cash availability position and arrive at the final indent on the T-2 day itself.
- v. The indented cash will be given to the CITs on T-1 day during the Banking hours.
- vi. The CITs to commence cash replenishment early morning next day i.e., the T Day and replenish all the machines on the T day for which the cash was provided to them on T-1 day.
- vii. In case, any machine is faulty and the fault can't be resolved at the time of cash replenishment, then the cash provided for that machine to be returned to the Branch before the closing hours of the Branch. In case of emergency, or Branch is closed, or any other cases deemed fit by the Bank, Bank shall provide specific instructions and permission for vaulting at vendor's risk. In case of vaulting, CIT shall store cash in locked and / or sealed containers in the vault, separate from other customers' valuables maintained at the vault. The Vendor & CIT should inform the Branch the next day and can use the cash for replenishing other ATMs by getting specific instruction from the Bank's designated linked Branch.



- viii. The Vendor should provide Cash Balance Report (CBR), Vault Closing Balance Report (VCB) and Overage & shortage report (OSR) to BANK designated linked branch daily via email. The Branch shall reconcile the same on daily basis.
- ix. Vendors / CITs should have adequate Insurance for the Bank's cash in vault / Cash -in transit and a copy of the same should be submitted at LHO.
- x. As daily vaulting is permitted, the vendors to ensure compliance on the following:
  - 
  - a) Cash outs should be zero. All efforts will be made by Bank to provide the indented cash 1 day prior with overnight vaulting provision in the required denominations.
  - b) ~~VIP / High-Hit ATMs to be replenished twice / thrice a day, if required, and without any cost to the bank~~
  - c) In no case, idle cash should be present in ATMs. There should not be over-indenting of cash.
  - d) Vaults will be subjected to audits by the RBI/ Bank / Auditors whenever required.
  - e) Sufficient insurance has to be ensured and a copy of the policy to be provided to LHOs.

**B. Wherever daily overnight Vaulting not available:**

- i. T day: Replenishment Day
- ii. The vendor will share the ATM wise, denomination-wise indent on T-1 day morning to the respective Currency Chest / Cash-linked Branche(s) as per the cash dispensation pattern of the respective ATMs.
- iii. The Branch and vendor to arrive at the final indent on T-1 day. The Branch shall keep the cash separately ready at T-1 End-of-day so that the cash be provided to CITs early morning on the T Day.
- iv. CITs to collect cash early morning in Bank working hours and commence replenishment on the T Day.
- v. The balance in CIT's zero balance account should be NIL by end of day. No cash shall be vaulted in CRAs offices/premises. In case of emergency or any other cases deemed fit by the Bank, Bank shall provide specific instructions and permission for storing of cash. In such case, CIT shall store cash in locked and/or sealed containers, separate from other customers' valuables maintained with

CIT. The amount of cash with CIT shall be reflecting in CIT's zero balance account.

#### **4.5.9.4.5 OTHER TERMS: -**

##### **i. Settlement & Vault Reporting:**

Vendor shall arrange ~~for daily~~ EOD as mentioned in Scope of Services under Cash Appendix of this RFP and prepare daily End-of-Day (EOD) activity report [ATM ID wise] as per prescribed format mentioned in Annexure-4 to this Cash Appendix, supervisory counters and admin slips under the signature of Vendor / their representative/s performing cash replenishment and submit to Bank same day but not later than next day. Vendor shall provide Cash Balance Report (CBR), Vault Closing Balance Report (VCB) and Overage & Shortage Report (OSR) as per format mentioned in Annexure-5 to Bank designated linked branch daily via e-mail.

##### **ii. Vault Balancing:**

Daily, Vendor shall provide CIT's records of cash received and cash disbursed to and from the vault with the previous day's verified records. The closing balance shown in the vault closing balance report (VCB) should be equal to balance reflected in the CIT's zero balance current account.

##### **iii. Currency Sorting:**

- A. The Vendor / CIT agencies shall check the quality and quantity of the currency notes at the time of delivery by the Bank before taking the same to their vaults or / and direct loadings in the machines. Bank shall take Undertaking Letter {as per format in Annexure-6 of this cash appendix} whenever the cash is handed over to Vendor / CIT. Acknowledgement of the cash handed over to Vendor / CIT to be taken in a register maintained for this purpose. If any shortfall is noticed thereafter, Vendor shall be responsible for the same. Wherever possible, Bank shall provide to the CIT agencies space and Note Sorting machines for the purpose. Any subsequent claim for any manner shall not be entertained by the bank.
- B. Any shortage of cash because of Vendor / CIT (engaged by the Vendor) activities, whatsoever and for whatever reason, shall be made good to the Bank within 7 days without waiting for admissibility or settlement of the insurance claim. In the event of failure on the part of the vendor to pay for cash losses as per the terms and conditions, the Bank shall be entitled to invoke the Bank Guarantee(s).
- C. The Vendor / CIT shall ensure correctness and genuineness of the cash and shall take only ATM / Endpoint fit currency notes for replenishment to its

possession. Counting facility for currency notes shall be provided by the Bank. Once the note packets are received and acknowledged, Vendor would be responsible for shortage and fake currency if any, noticed subsequently. A penalty of Rs 10,000/- per instance will be levied on the vendor whenever any Counterfeit Currency is detected by any manner from the following: -

- a) Evacuated cash from the ATM
- b) Unreplenished cash returned to the Bank by Vendor / CIT,
- c) Genuine ATM-fit notes given by the Bank to Vendor / CIT for cash replenishment in ATM but counterfeit notes were mixed / exchanged with genuine ones and replenished in ATMs by Vendor / CIT.
- d) Vendor shall compensate any loss to the Bank and / or penalty imposed on the Bank due to counterfeit currency.
- e) Vendor shall be responsible to make good the amount equivalent to the value of the counterfeit note immediately.

**iv. Cash out Exclusions:**

Vendor shall not be responsible for cash outs and related downtime of endpoint, if it arises due to following reasons:

- a) ~~Quantum of cash not received as per indents raised by Vendor. However, bank has discretion to provide lesser quantum of cash than the indents raised by vendor considering the dispensation pattern of Endpoint and the cash available with the Bank Branch.~~ Quantum of cash not received as per indents raised by Vendor based on the dispensation pattern of Endpoint(s) and / or as per the envisaged Factor of safety (FoS) mentioned in this RFP.
- b) If the Endpoint stops dispensing a particular denomination and it is needed that the ATM should be configured to continue dispensing the other remaining denomination.

**4.5.9.4.6 USE OF ONE TIME COMBINATION (OTC) FOR ENDPOINT VAULTS: -**

- i. Vendor has to ensure that all Endpoints are operated for cash activities only with digital One Time Combination (OTC) locks. Any key / hardware required to operationalize and use OTC must be arranged by the Bidder at their own cost. Endpoints are to be made cash live with OTC. Any machine which is Cash live and not OTC enabled, will attract penal provisions of Rs. 500/- per day till the date on which the machine is OTC enabled.
- ii. The cost of combination lock including all keys (Black and red), any peripherals, any hardware (like Bluetooth dongle / devise for usage of OTC) if required to be replaced during the contract period shall be borne by Vendor, without any cost to Bank. Any defective lock shall be broken open by Vendor at their cost. Further, breaking open the safe lock shall be required to be done

without any additional cost to the Bank and the liability of any destroyed currency in the safe rests with the Vendor.

- iii. The combination lock should be made compatible with the Bank's OTC Infrastructure, if required by the Bank, without any additional cost to Bank.
- iv. Endpoint serviced, pursuant to this RFP, shall be equipped with the Mas Hamilton / KABA / S&G Lock / Securam or equivalent One Time Combination (OTC) locks. Vendor or appointed CIT shall: -
  - a. Cooperate in implementation of the OTC solution.
  - b. Implement centralized and mobile based OTC solution.
  - c. Adhere to all security protocols for OTC solution.
  - d. Activate OTC lock to route mode during Initial Currency Load.
  - e. Acquire, implement and operate the one-time combination dispatch software in route mode.
  - f. Make its records / audit trails available as and when necessary to investigate any operational issue or loss.
- v. The Vendor / CRA shall have necessary infrastructure and software required to generate and communicate one time password to its joint custodians at site. Vendor / CRA shall mandatorily use OTC solution for every cash related activity at all sites. The Vendor shall have the capability of takeover of OTC password generation process from CRA within shortest time, in case of any exigency.
- vi. Vendor / CIT shall start cash replenishment service only after successful activation of OTC in cash vaults of the machine.
- vii. For the purpose of cash replenishment / cash evacuation, Vendor / CIT shall have a crew of two custodians and one-time combination to open the cash vault using the OTC Solution.
- ~~viii. CIT shall use secured cash van as per the specifications given in Annexure-1. The CRA / CIT shall ensure that cash shall always be in joint custody of two persons and single individual is not allowed to handle cash at any time. Further, security guards shall be in each vehicle for transportation of cash safely and efficiently as per RBI / MHA Guidelines.~~
- ~~ix. If the Bank provides a generic tool for monitoring of movement of cash the Vendor shall integrate it with their system without any additional cost to the Bank.~~

- x. Vendor shall submit Board approved Business Continuity Plan (BCP) / Disaster Recovery Plan (DRP) for OTC Solutions used for Cash Replenishment / Evacuation services, acceptable to the Bank.

#### **4.5.9.4.7 INSURANCE: -**

- i. It is the sole responsibility of the Vendor to obtain adequate insurance cover for all the Endpoints, allied equipments, Site, other infrastructure owned & deployed by the Vendor, Cash in transit, Cash in the Endpoints and Cash held in Vault of Vendor / Cash Management Agency. The Vendor is responsible to reimburse the Bank the loss of Cash in transit, Cash in Endpoints, cash held in Vault of Cash Management Agency without waiting for settlement of Insurance claim and within 15 (fifteen) working days from the date of loss. In the event of failure on the part of the vendor to pay for cash losses, Bank shall be entitled to invoke the Bank Guarantee(s).
- ii. The Vendor should ensure that the entire cash of the Bank handled by it in transit / in Endpoints / in vault of cash management agency, is adequately insured, with the Bank as beneficiary. Vendor should submit cash insurance cover to the Bank.
- iii. The Vendor will keep all the Endpoints insured against theft, fire and any other damage which may result loss / damage to the cash kept inside the Endpoints. Fidelity insurance shall also be with the Vendor. The Vendor shall be liable to the Bank for the any loss so caused in all conditions (whether insurance claim is settled by the Insurance Company or not) within 15 (fifteen) working days from the date of loss. Bank does not demand an exclusive policy if CRA is under an umbrella policy of the Insurance Agency. Fidelity insurance cover should be for 20% higher limit than maximum cash withdrawn from currency chest on a particular day shall be obtained by CRA.

#### **4.5.9.4.8 BANK GUARANTEE FOR CASH SERVICES: -**

The Vendor shall submit to the concerned LHOs / Circles, a Bank Guarantee for the term of 96 months (including claim period) @ Rs. 50,000/- per Endpoint in the specified format for securing the obligations in respect of cash loss in the number of Endpoints allotted in each LHO / Circle during the contract period and extension thereof. For any further addition of Endpoints allotted to the Vendor during the currency of the agreement, additional Bank Guarantee, on the same terms and conditions for added number of Endpoints, shall have to be provided by the Vendor to the LHOs / Circles. In the event of failure on the part of the vendor to pay for cash losses, the Bank shall be entitled to invoke the Bank Guarantee(s).

#### **4.5.9.4.9 CASH RECONCILIATION: -**

- i. Cash difference (excess or short), if any, has to be reported to the Bank on same day but not later than next day, failing which the Vendor shall be liable for the loss incurred by the Bank (if any).
- ii. Any cash loss to the Bank due to cash shortage in endpoints shall be intimated to the Vendor, with supporting documents / proofs after submission of reports by the Vendor. The Vendor shall respond to such communication within 3 calendar days from the receipt of the intimation failing which, Vendor shall be liable for the said loss. Supporting documents / proofs include but are not limited to:
  - a) Cash replenishment report, Cash Evacuation report, JP logs (only if JP is installed / enabled) / EJ and ATM counters for the time period the variance was discovered and the same report(s) for the previous and post settlement periods.
  - b) Copies of Bank's ATM reconciliation reports indicating the ATM's beginning, ending and dispensed totals for the time period the variance was discovered.
  - c) Cash balance report (CBR) including excess/short and no difference Cash report,
  - d) Copies of the suspect transactions report.
  - e) Bank's calculation of the claimed variance.

#### **4.5.9.4.10 RECOVERY OF LOSSES: -**

- i. In case of any ATM loss (es), discrepancy / difference in the report generated on the ATM and the physical / actual cash, if after Vendor investigation, it is proved that the shortage / difference of cash, if any, between the report generated and the physical cash, is on account of the lapses on the part of the CIT, Vendor shall make the payment within 7 (seven) days from the day it is proved.
- ii. Vault Loss (es) and Transit Loss (es), if any, shall be by made good by Vendor to BANK within 15 (Fifteen) days of occurrence of such loss without waiting for admissibility or settlement of the insurance claim. If the Vendor fails to make such

payment with the said period of 15 days, then Bank reserves the right to recover the same by invoking the Bank guarantee.

- iii. Defrauded amount if any, shall be by made good along with interest thereon at Banks' prevailing clean overdraft interest rate at material time along with penalty at the rate of Rs.10,000 per Rs. One lakh or part thereof, by Vendor to Bank within 30 (thirty) days of occurrence of such fraud without waiting for admissibility or settlement of the insurance claim, if any. If the Vendor fails to make such payment with the said period of 30 days, then Bank reserves the right to recover the same from monthly invoices or / and by invoking the Bank Guarantee(s) submitted.

#### **4.5.9.4.11 NOTICE OF SHORTAGES, LOSS AND OVERAGES; CLAIMS: -**

- i. If the reports provided by Vendor, or other records or information of which Bank become aware, reveal a discrepancy (loss or overage), Bank shall give written notice of the discrepancy after the earlier of:
  - (a) Vendor's delivery of tapes, reports, or other records which provide sufficient information to disclose, upon reasonable review, the discrepancy;
  - or**
  - (b) such time as Bank become aware of the discrepancy through any other means.

This notice is intended to permit Vendor to commence its investigation and does not constitute a claim of loss.

- ii. Along notice required, Bank shall provide Vendor with a claim and affirmative written proof of any ATM Loss, subscribed and sworn to by Bank, and substantiated by Bank's books, records and accounts, within the time prescribed herein. Bank shall retain and provide to Vendor upon request any documentation provided to Bank by the CIT (including but not limited to vault documentation) relating to the ATM Loss, and Bank agree, upon Vendor's request, to make available during regular business hours Bank's books, records, and accounts which relate to the alleged ATM Loss, and shall cooperate with and assist in the investigation thereof, including sharing with Vendor all information that any person may have concerning the alleged ATM Loss and the circumstances surrounding the same. Each party's investigation shall include cooperating with the policies, procedures and requests for information of the internal security departments of the other party. Each party shall make available to the other party all records relating to the ATM Loss including, but not limited to, investigative reports and all records relating to access to the ATM.
- iii. Unless the notice of discrepancy required, and a claim and proof of ATM Loss are timely delivered to all addressees, all claims shall be deemed to have been waived. No action, suit or proceeding to recover for any such ATM Loss may be brought against Vendor unless such action, suit or proceeding is commenced no sooner than six months and not later than twelve months from the time a claim is made.

- iv. All notices and claims (including copies) must be delivered by express mail, same-day or overnight courier providing proof of delivery. Notices by Bank to Vendor / OEM over registered Email / address shall be deemed given on the day received.

**4.5.9.4.12 LIABILITY: -**

- i. The provisions of this Section govern the liability of Vendor and Vendor's subcontractor (collectively for the purposes of this section, "Vendor") for any claim of Damage, lost, missing, or stolen Currency and, with respect to such losses, supersede any inconsistent provision in Agreement or any other agreement, addendum, or appendix signed by the parties.
- ii. For the purposes of this Cash Appendix, the amounts of the following defined terms shall be:
  - a. Transit Loss liability for the Vendor will be the total amount given by the Bank to the vendor or to the CIT agencies engaged by them.
  - b. Vault Loss liability for the Vendor will be the total amount given by the Bank to the vendor or to the CIT agencies engaged by them less the amount actually replenished out of that total amount plus the amount actually evacuated, if any.
  - c. In case of exigencies, like continuous Holidays, festival seasons, etc. whenever the vault limit is increased by LHO, the above loss liability limits shall increase accordingly. Insurance policy should be able to cover the enhanced vault limits.
- iii. Vendor shall be liable for ATM Loss, Transit Loss and Vault Loss or any other type of loss in any scenario.,
- iv. Vendor's total liability for any single ATM Loss shall in no event exceed the **ATM Loss Liability Limit**.
- v. Vendor shall be liable for any Vault Loss up to the Vault Loss Liability Limit. Vendor's liability shall commence when Currencies have been delivered into a vault or other secured facility owned, operated by, or under the control of CIT, and shall terminate when they are either (a) delivered to Bank or Bank's designated consignee or agent; or (b) placed in a Secured Cash Van owned, operated by, or under the control of CIT.
- vi. Vendor shall be liable for any Transit Loss up to the Transit Loss Liability Limit. Vendor's liability shall commence when Currencies have been placed in CIT's Secured Cash Van and shall terminate when they are either (a) delivered to Bank or Bank's designated consignee or agent; or (b) delivered to, and deposited in, an ATM and CIT has secured the ATM vault and departed from the room or immediate area where the ATM is located.



- vii. In addition to the damages and remedies expressly set forth in this Cash Appendix, Vendor shall be liable to Bank, either directly or bypass-through claims of indemnity or contribution for claims of third parties, for any moneys, damages, relief, or remedies, irrespective of whether the claim arises in common law, tort, statute, or equity.
- viii. If Bank and Vendor are unable to agree upon responsibility for an ATM Loss, the parties shall escalate the issue to their senior management, who shall meet either in person or by telephone in an attempt to resolve the dispute. If the parties disagree after that meeting, either party may invoke binding arbitration.

**4.5.9.4.13 ACCESS TO EQUIPMENT: -**

Bank agrees that neither Bank's employees nor any third party shall have access to ATM vaults.

**4.5.9.4.14 ACCEPTANCE AND VERIFICATION: -**

- i. Bank acknowledges that under the terms of the Subcontract, the CIT agrees to accept ATM-fit Currency from Bank or Bank's designated agent but may refuse to accept any package that is not accompanied by a written receipt which contains a statement of the value of the Currency in the package. CIT shall sort and verify the cash in Bank's premises if Bank provides space and machines for counting of notes. Where Bank does not provide space and machine on its premises to count the currency, the CIT shall sort and verify by Note Sorting Machine (NSM) on same working day of receipt any Currency shipments accepted on Bank's behalf. Verification shall be performed under videotaped CCTV surveillance and documented dual control.
- ii. Bank shall cooperate to recover Valuables, including correcting the transaction (debiting the account) of any customer for an ATM Loss due to improperly dispensed Currency as a result of mis-loaded denominations, mis-configured cassettes, or mis-loaded cassettes.
- iii. Due diligence shall be done by Vendor's CIT to identify forged notes. The forged notes found during sorting by the CIT, the same shall be returned to Bank and the Bank shall accept the same. Notes once accepted by either party shall be its sole responsibility.

**4.5.9.4.15 SERVICE LIMITATIONS:**

If Service is required on ATMs under circumstances that could jeopardize the safety of Vendor personnel (such as calls to ATMs requiring work in the open, where lights are burned out, or where other dangerous conditions exist), Vendor reserves the right to reschedule service. Vendor shall use its best efforts to notify Bank immediately if these

circumstances apply. Vendor may recommend changes to the ATM site designed to improve safety and enable Vendor to service the ATM without limitation.

**4.5.9.4.16 BANK'S RESPONSIBILITIES: -**

- i. Bank shall open Vendor-CIT wise identifier linked with BGL account for issuing cash.
- ii. Cash shall be issued by Bank from one or more designated branch in each city identified for this purpose.
- iii. In case of overnight vaulting not available at a particular Centre, the Bank may approve of Branch-to-ATM loading.

**4.5.9.4.17 CONTINGENCY ARRANGEMENTS: -**

The Vendor must have in place an appropriate and viable Contingency Plan to arrange for alternate service providers in case the subcontractor managing the Cash Replenishment Services for them is, for any unforeseen reason, unable to extend the services temporarily or otherwise.

## ANNEXURE-1: Criteria for Selection of CRA/CIT

1. (Vendors to meticulously adhere the Standards for engaging the Service Provider and its sub-contractor relating to Cash Management activities issued by the Regulator and GOI from time-to-time. Latest instructions on this subject issued by RBI vide their letter No. RBI/2017-18/152 DCM(Plg) No. 3563/10.25.07/2017-18 dated April 06, 2018, and Gazette Notification issued by Ministry of Home Affairs, New Delhi on 8<sup>th</sup> Aug. 2018. Vendors shall also adhere further refinement issued by our Bank from time to time.).
2. Vendor may subcontract (after bank approval) the activities for Cash Replenishment Services (CRS)/Cash Evacuation Services (CES) to reputed Cash Replenishment Agencies (CRA)/Cash-in-Transit Agencies (CIT), On subcontracting the above referred activity, Vendor shall ensure to fulfil the following criteria/ rules as under:
3. **Definitions.** — In these rules, unless the context otherwise requires, —
  - (a) “Act” means the Private Security Agencies (Regulation) Act, 2005 (29 of 2005);
  - (b) “ATM” means the automatic teller machine that dispenses cash or performs other banking services when an account holder of any bank inserts a Bank card therein; cardless transactions through ATM shall also include in this definition.

Explanation – For the purposes of this clause, “Bank card” includes credit card or debit card.

- (c) “cash handling agency”, “cash replenishment agency” or “cash-in-transit agency” means an agency or entity, by whatever name called, engaged in cash transportation activities;
- (d) “cash transportation activities” means the physical transfer of cash, such as banknotes, coins, credit card, debit card or other items of value from one location to another, and includes loading cash in to, or unloading cash from, an ATM machine;
- (e) “private security” or “private security agency” shall have the same meaning as assigned to it in clause (f) or clause (g) of section 2 of the Private Security Agencies (Regulation) Act, 2005;
- (f) “Schedule” means a Schedule appended to these rules.

### 4. Eligibility Criteria

- (i) CRA shall be registered as a company under the Indian Companies Act 2013.
- (ii) Cash replenishment/Cash handling/Cash evacuation shall be one of the main/core activities of the agency with at least 3 years’ experience in handling the activity,
- (iii) CRA shall be engaged in cash replenishment in ATMs / ADWMs at a minimum of 50 centres and/or 5000 ATMs across the country for a minimum of 3 banks at least for last

3 years. Certificate of good performance from these banks shall be submitted to Bank's LHO

**A. Financial:**

- a. Financial minimum net worth requirement of ₹ 1 billion. The net worth of at least Rs 1 billion should be maintained at all times.
- b. MS Vendor shall obtain copies of CRA's last 2 audited balance sheets and certified copies of annual reports and submit a copy of the same to the respective Local Head Office of SBI.

**B. Physical/ Security Infrastructure:**

- a. Minimum fleet size of 300 specifically fabricated cash vans (owned / leased).
- b. Cash should be transported only in the owned / leased security cash vans of the Service Provider or its first level sub-contractors. Further requirements are given below -

**C. Use of specially designed and fabricated cash van:**

- a. No private security agency shall provide private security or private security guards to a Bank or a cash handling agency for cash transportation activities, unless such activities are carried out in a secured cash van, which complies with the conditions for design and specification specified in the First Schedule (given below), owned by it or owned by the Bank or the cash handling agency, as the case may be.
- b. No taxi or hired vehicle shall be used for cash transportation activities by the private security agency:

Provided that a vehicle which is on long term contract with the private security agency or Bank or cash handling agency and the vehicle complies with the conditions for design and specification laid down under sub-rule 4 (1) of MHA Model Rules may be used by the private security agency:

Provided further that in case of any remote location where private security agencies are not present and not serviced by a currency chest, any vehicle at such location may be used as an exception under the strict security control and support of the local police.

**THE FIRST SCHEDULE**

[See rule 4(1) of MHA Model Rules

**1) DESIGN AND SPECIFICATION FOR SECURED CASH VANS**

**a) Make.** — The cash van shall—

- be a Light Commercial Vehicle, with an engine capacity of not less than 2200 CC, preferably turbocharged.
- be not more than seven years old;
- have tubeless tyres;
- have a ground clearance of not less than 190 mm; and  
the passenger cabin should have factory built 4 doors and two rows of seats to accommodate 1 driver plus 1 armed security guard in front row and 3 passengers, including one armed security guard in the second row.

**b) Layout.** — (i) Each cash van should be a specially designed and fabricated Light Commercial Vehicle (LCV) having separate passenger and cash compartments, with a CCTV covering both compartments. The cash van shall have the compartment for storing cash, physically separated and locked from the passenger compartment unit;

- c) Cash compartment security.** — (i) The cash compartment should be inaccessible from outside the van unless operated internally through manual or electronic lock and cash compartment is specially reinforced with steel with only one door and grill gate;
- ii) the entrance of the cash compartment shall be from the rear side to ensure proper visibility, operational feasibility and CCTV surveillance
  - iii) all windows and wind screen shall have wire mesh protection of not more than one square inch and each window mesh shall have a circular port-hole of six inches diameter for use of weapons
  - iv) the panic switches for operating the hooter are available with the driver and other occupants.

**d) Cash box security.** — Each of the cash boxes shall be secured to the floor with separate chains and have locks that can be opened or locked only by using separate keys kept with different custodians and cash for each bank shall be carried, preferably, in a separate box with the name of the bank written on it.

**e) Other security features.** — (i) The cash van shall be provided with a small CCTV system with at least five days recording facility and three cameras installed in front, rear and inside of the cabin.

- ii) A security alarm with GSM based auto-dialer shall be provided with a motorized siren.
- iii) The cash van shall be equipped with hooter, fire extinguishers and emergency lights to ensure quick reaction in case of an attack.

**f) Requisite number of trained staff per cash van.** — (1) The private security agency shall provide the private security for the cash transportation activities with the requisite number of trained staff, directly appointed or engaged by the private security agency, as specified in sub-rule (2) of the said Gazette Notification dated Aug. 8, 2018(given below).

(2) Every cash van shall have the following minimum staff, possessing the qualifications and training laid down under section 10 of the Act, on board for every single cash

transportation activities, namely: —i) Driver – one; ii) Armed security guards – two; and iii) ATM officer or custodian – two.

(3) The cash van shall always be escorted by at least two trained armed security guards on board:

Provided that more than two-armed security guard may be deputed on a cash van depending on the amount of cash carried and in accordance with the individual company's insurance guidelines or client contract or terrain of operation.

The passenger compartment should accommodate two custodians and two-armed security guards (gunmen) besides the driver.

(4) Where the cash van is a medium motor vehicle, one armed guard shall sit in the front along with the driver and another in the rear portion of the van and while in transit, loading or unloading, nature's call, tea or lunch break, at least one-armed security guard shall remain present with the cash van all the time.

Notwithstanding any other provision in these rules, the ex-serviceman, otherwise eligible, may preferably be appointed or engaged by the private security agency for providing security for cash transportation activities.

(5) No cash van should move without armed guards. The gunmen must carry their weapons in a functional condition along with valid gun licenses. The Service Provider or its first level sub-contractor should also furnish the list of its employed gunmen to the police authorities concerned.

(6) **Live GPS tracking of cash van during operations** i) Every cash transportation activities shall be carried out only in secured cash vans fitted with GPS tracking device. Each cash van should be GPS enabled and monitored live with geo-fencing mapping with the additional indication of the nearest police station in the corridor for emergency.

*Explanation.*— For the purposes of this sub-rule, the expression “GPS” means the global positioning system which is a space-based navigation system that provides location and time information in all weather conditions, anywhere on or near the Earth where there is an unobstructed line of sight to four or more GPS satellites

ii) The private security agency shall ensure that each cash van shall be monitored live at all times during cash transportation activities through a redundant communications protocol and with geo-fencing mapping with the additional indication of the nearest police station in the corridor for emergency.

(7) Each cash van should have wireless (mobile) communication and hooters. The vans should not follow the same route and timing repeatedly so as to become predictable. Predictable movement on regular routes must be discouraged. Staff should be rotated and assigned only on the day of the trip. With regard to security, additional regulations / guidelines as prescribed by Private Security Agencies (Regulation) Act, 2005, the Government of India and the State Governments from time to time must be adhered to.

(8) Night movement of cash vans should be discouraged. All cash movements should be carried out during daylight. There can be some relaxation in metro and urban areas though depending on the law-and-order situation specific to the place or the guidelines issued by the local police. If the cash van has to make a night halt, it necessarily has to be in a police station. In case of inter-state movement, changeover of security personnel at the border crossing must be pre-arranged.

(9) Proper documentation including a letter from the remitting bank should be carried invariably in the cash van, at all times, particularly for inter-state movement of currency.

(10) ATM operations should be carried out only by certified personnel who have completed minimum hours of classroom learning and training. The content of such training may be certified by a Self-Regulatory Organisation (SRO) of Cash-in-Transit (CIT) Companies / Cash Replenishment Agencies (CRAs) who may tie up with agencies like National Skill Development Corporation for delivery of the courses.

(11) The staff associated with cash handling should be adequately trained and duly certified through an accreditation process. Certification could be carried out through the SRO or other designated agencies.

(12) Character and antecedent verification of all crew members associated with cash van movement, should be done meticulously. Strict background check of the employees should include police verification of at least the last two addresses. Such verification should be updated periodically and shared on a common database at industry level. The SRO can play a proactive role in creating a common data base for the industry. In case of dismissal of an employee, the CIT / CRA concerned should immediately inform the police with details. Further requirements are given below –

**Antecedent check of personnel.** — (1) No private security agency shall appoint or engage or deploy any personnel for the cash transportation activities, unless such personnel have undergone thorough antecedent check and his proper KYC verification and police verification is done, before appointing or engaging or deploying them by the agency, in accordance with the provisions of the Act or any other law for the time being in force.

*Explanation.* — For the purposes of this sub-rule, the expression “KYC” means the know your customer process of an agency or business identifying and verifying the identity of its clients or person associated or to be associated with the agency or business.

(2) Every private security agency shall be responsible to comply with the following checks before an individual is appointed or engaged to participate in cash transportation activities, namely: —

a) police clearance certificate – every individual shall obtain the police clearance certificate from his local police station before appointment or engagement.

b) residence verification – the private security agency shall use its own resources to conduct a physical verification of the residential address of every individual, including general conduct check and the individual shall furnish to the security agency the proof

of residential address of at least three years before appointment or engagement for the cash transportation activities.

c) previous employer check – the private security agency shall use its own resources to conduct reference check with previous employers of the individual, if any.

d) Aadhaar verification – each individual appointed or engaged for the cash transportation activities shall be antecedent verified through Aadhaar number from the Unique Identification Authority of India;

e) credit history check – the private security agency shall conduct a credit history check of every individual appointed or engaged to ensure that willful credit defaulters are not appointed or engaged for the cash transportation activities;

(f) Fidelity insurance – the private security agency shall obtain a fidelity insurance in respect of every personnel appointed or engaged for the cash transportation activities.

(13) Safe and secure premises of adequate size for cash processing / handling and vaulting. The premises should be under electronic surveillance and monitoring round the clock. Technical specifications of the vault should not be inferior to the minimum standards for Chests prescribed by the Reserve Bank. The vault should be operated only in joint custody and should have colour coded bins for easier storage and retrieval of different types of contents.

(14) All fire safety gadgets should be available and working in the vault which should also be equipped with other standard security systems like CCTV monitoring with recording for at least 180 days, emergency alarm, burglar alarm, hotline with the nearest police station, lighting power backup and interlocking vault entry doors.

(15) Work area should be separate from the cash area. The premises should be under the security of armed guards whose number should have reference to the scale of operations specific to the location but not less than five in any case.

(16) Critical information like customer account data should be kept highly secure. Access to the switch server should be restricted to banks. Interfaces where a bank gives access to the service provider or its sub-contractor to the bank's internal server should be limited to relevant information and secured.

#### **Other Point**

i) All Cash Replenishment Agencies (CRAs) shall be required to have certain basic infrastructure, resources and other assets / equipment to be in a position to provide the Cash-in-Transit / Cash Replenishment/ Cash evacuation & other associated services to the Bank.

ii) Vendor shall verify vaulting facility and overnight holding pattern before outsourcing work to the CRA and submit a certificate to the Bank/Circle to this effect. Bank/Circle may also verify vaulting facility to ensure the adherence to prescribed norm



iii) CRAs shall enhance / adjust the crew complement with consent of the Bank based on cash load and risk assessment in the specific geography of operation

iv) Wherever possible (especially at Metro and big cities where Bank has more than 15 ATM/CD/CDM/Cash Recycler) CRA shall provide exclusive van for cash related activities of the Bank.

v) Recruitment of Operational staff: Protocols stated below shall be followed to minimize loss due to fidelity/employee errors and also improve quality of operations

vi) All employees on company's/Vendor's payroll shall comply with minimum wage, PF, ESIC norms as applicable based on their skill levels. Vendor's HR department shall conduct a thorough scrutiny of employee credentials before selection. Pre-recruitment formalities shall include Police verification of the employee

vii) Training facilities for imparting necessary trainings for all categories of staff shall be set up. Compulsory induction training of 80 hours shall be imparted as a combination of classroom training and on-field training. Refresher training shall be conducted once every year

viii) Necessary registration from ESI/EPFO, as applicable, is mandatory.

(ix) Bank/ Circle shall undertake periodic verification of cash held on its behalf by the CRA. The Vendor shall ensure that cash verification by Bank's officials / authorized agents is allowed by the concerned CRA.

**(x) Private Security for cash transportation activities, etc.-** (1) No private security shall be provided by the private security agency for cash transportation activities unless he holds a license under the Act.

i. For the purpose of providing private security for cash transportation activities, a contract may be entered into between, -

(a) a private security agency holding a license under the Act and the MS Vendor/ CIT/CRA or

(b) a cash handling agency and the MS vendor/ CIT/CRA concerned:

Provided that in case the cash handling agency holds a license as a private security agency under the provisions of the Act, such cash handling agency may itself provide the private security to cash transportation activities in accordance with the provisions of these rules.

**(xi) Adequate training and certification of personnel. —**

(a) The private security agency shall ensure that every personnel appointed or engaged for cash transportation activities shall be imparted, -

(b) the training and certified for the security and safe handling of such activities as per the requirements of training laid down in the Second Schedule of the said Gazette Notification dated Aug. 8, 2018(given below);

(c) the refresher training once in every two years.

**(xii) Guideline for maximum cash carrying limit in a single cash van.—** The private security agency involved in cash transportation activities shall ensure that no cash van carries cash of more than five crores rupees per trip.

**(xiii) Specification for private cash vaults used for holding and overnight vaulting of Bank currency. —** The private security agency shall ensure that all cash handling, including counting, sorting, and bundling activities shall be carried out in secured premises in accordance with the following guidelines, namely: —

**a)** Location of private cash vault premises – the premises used for cash handling activities shall be located to ensure safety of activities/ operations, including areas closer to bank's cash withdrawal centre or police station and secluded areas with poor connectivity be avoided.

**b)** Design of premises – the premises shall be designed to include two physically independent areas, one for general office purpose and other for secured cash processing and handling activities and it shall accommodate space for cash deposit, collection, sorting, counting and delivery and dispatch of cash on secured cash vans.

**c)** Cash vault – a secured area shall be designed to store cash to meet with the requirement of the Reserve Bank of India specified for cash vaults in accordance with the following specifications, namely: —

i) in smaller cities with limited overnight vaulting requirements of less than ten crore rupees, a strong room with safes;

ii) at operation centres with overnight vaulting requirements between ten to one hundred crore rupees, vaulting facility as per the norms of the Reserve Bank of India specified for C Class vaults.

iii) at large operation centres with overnight vaulting requirements of more than one hundred crore rupees, increased vaulting facility in consultation with the Bank/ Circle; and

iv) all overnight vaulting facilities shall have provision to store currency of multiple Banks in separate and exclusive bins;

**d)** Security of cash vault – the private security agency shall ensure the following security aspects at its cash vault used for secured handling of cash on behalf of the Bank, namely: —

- i) adequate number of armed private security guards are deputed round the clock.
- ii) premises is under 24x7 electronic surveillance and monitoring.
- iii) cash vault is provided with CCTV system with adequate number of cameras having at least 90 days recording facility.
- iv) the activities at cash vault is undertaken under dual custody basis.
- v) the main cash vault area complies with all safety norms, like firefighting systems, smoke detection systems, emergency lighting, control room for monitoring the movement of vehicles, auto-dialer and burglar security systems.
- vi) security alarm with GSM based auto dialer, fire and magnetic sensor are installed.
- vii) the loading and unloading area of cash is covered by night vision CCTV cameras.
- viii) electric power supply inside the cash vault is provided through plug-in, plug-out system.
- (ix) carrying of naked light inside the cash vault is strictly prohibited and dry battery-operated torches or emergency lights are used inside strong rooms.
- (x) emergency lighting with the help of inverter shall always be available to the security staff; and
- (xi) cash processing and vault areas shall have restricted and controlled access, preferably through interlocking systems and frisking.

Explanation - For the purposes of this rule, the expression "CCTV" means the closed circuit television which is a self-contained surveillance system comprising cameras, recorders and displays for monitoring activities in a store or company.

**(xiv) Measures for risk mitigation. —** (1) The private security agency shall ensure that the ATM under its security shall be fitted with one-time electronic combination locks for reducing the instances of crew pilferage losses and ATM frauds.

i. The cash for loading into an ATM machine shall be collected from the Bank on previous day or in the first half of the day so that operations can be concluded before the time stipulated in sub-rule (3) of the said Gazette Notification dated Aug. 8, 2018(given below).

ii. No cash loading of the ATMs or cash transportation activities shall be done —

- (a) after 9 PM in urban areas;
- (b) after 6 PM in rural areas; and
- (c) before 9 AM or after 4 PM in the districts notified by the Central Government as Left-Wing Extremism (LWE) affected areas.

## **THE SECOND SCHEDULE**

[See rule 7(1) (a) of MHA Model Rules]

### **(1) TRAINING FOR PERSONNEL APPOINTED OR ENGAGED IN CASH TRANSPORTATION ACTIVITIES**

(a) Basics of cash handling and cash transportation activities

- (i) Scope of service
- (ii) Team composition
- (iii) Role of driver, armed guard, cash custodian
- (iv) Functioning of cash vans
- (v) Contact details of concerned agencies
- (vi) Threat and risks involved
- (vii) Reporting procedure

(b) Threat and risks

- (i) Criminal and miscreant action
- (ii) Tailing by vehicle-borne criminals
- (iii) Specific threats to stationary and moving vehicle
- (iv) Insider's threat
- (v) Fraudulent practices by team members
- (vi) Loss of life and medical emergency
- (vii) Road accident and vehicle breakdown
- viii) Fire accident

(c) Safety and security of cash van —

- (i) In-built safety features of the cash van carrying cash and valuables
- (ii) Cash boxed for carrying cash and valuables
- (iii) Locking and security systems
- (iv) Weapon and ammunition
- (v) Communication equipment
- (vi) Global Positioning System
- (vii) Fire extinguishers
- (viii) Distress alarm
- (ix) First-aid kit

(d) Agencies —

- (i) Controlling Authority under the Private Security Agencies (Regulation) Act, 2005 (29 of 2005)
- (ii) Police station, PCR vans, police helpline
- (iii) Controlling supervisor and operations manager
- (iv) Concerned Bank representative

(v) Ambulance and hospital services

(e) Weapons, ammunition and documents. —

(i) Minimum 12 bore DBBL shot gun should be provided to the guards. Gun must be test fired at least once in two years. Gun cartridges must be replaced once in 02 years. Gun must be checked and certified by a government approved armourer

(ii) Documents – gun licence, identity card and permission to carry weapon during restrictions imposed by authorities

(iii) Real weapons carried by miscreants

(iv) Other objects which can be used as weapon by miscreants

(f) Emergency and incident response. —

(i) Distress alarm procedure

(ii) Seeking help from concerned agencies

(iii) Use of weapon to deter and resist criminals and miscreants

(iv) Ensure safety of team members and consignment

(v) Disengage from situation and drive vehicle to safety

(vi) Evacuation of the injured

(g) Other internal organisational procedures. —

(i) Antecedent check procedure

(ii) The Provident Funds Act, 1925 (19 of 1925) and benefits

(iii) The Minimum Wages Act, 1948 (11 of 1948) and benefits

(iv) The Employees State Insurance Act, 1948 (34 of 1948) and benefits

(v) Leave entitlement and application procedure

(vi) Other company rules

(vii) Obligations as employee

## ANNEXURE-2 of CASH APPENDIX

### Cash Withdrawal Requisition Slip

Voucher No.	Order No.:
Bank:	Order Date:
Operation Dt.	
Replenishment Type:	Scheduled/Emergency

Please disburse Rs. (in figures) .....Rs. (in words) ..... to our representative whose signatures are attested below:

Denomination	Pieces	Amount (Rs.) required
<b>2,000</b>		
<b>500</b>		
<b>200</b>		
<b>100</b>		
<b>TOTAL</b>		

Remarks:.....

Attested Signatures of Cash withdrawees:

Custodian 1 :..... Custodian 2 :.....  
 Signature :..... Signature: .....

.....  
 (Authorized Signatory – 1)                      (Authorized Signatory – II)

OPENING VAULT BALANCE

Rs.      (in      figures)      \_\_\_\_\_      Rs.      (in      words)  
 \_\_\_\_\_  
 .....

CASH ACKNOWLEDGMENT RECEIPT

Amount of Cash received by

Denomination	Pieces	Amount (Rs.) required
<b>2,000</b>		
<b>500</b>		
<b>200</b>		
<b>100</b>		
<b>TOTAL</b>		



## ANNEXURE-4 OF CASH APPENDIX

### Daily End of Day Activity Report

ATM ID		CITY	
<b>OPENING CASH BALANCE (A)</b>			
	Count	Amount	
500 X			
200 X			
100 X			
50 X			
<b>Total</b>			

DATE		CBR TIME	
<b>CASH DISPENSED (B)</b>			
	Count	Amount	
500 X			
200 X			
100 X			
50 X			
<b>Total</b>			

<b>(C) Balance as per proof (A - B)</b>	
---	--

<b>PHYSICAL CASH COUNT (D)</b>		
	Count	Amount
500x		
200x		
100x		
100x		
<b>TOTAL</b>		

<b>CASH IN PURGE BIN (E)</b>		
	Count	Amount
500x		
200x		
100x		
100x		
<b>TOTAL</b>		

<b>(F) Total of Physical Cash and Purge Bin (D+E)</b>	
---	--

Shortage (C-F,0) =	
-----------------------	--

Overage (C-F<0) =	
----------------------	--

<b>TOTAL CASH REMOVED/LOADED (H)</b>		
	Count	Amount
500x		
200x		



100x		
100x		
TOTAL		

CLOSING BALANCE (H+/-F)		
	Count	Amount
500x		
200x		
100x		
100x		
TOTAL		

<b>AUDIT ROLL DETAILS</b>
---------------------------

AVAILABLE AUDIT ROLLS		
Date	Txns from	Txns to

MISSINGg AUDIT ROLLS		
Date	Txns from	Txns to

LIST OF ENCLOSURES	

CUSTODIAN 1:  
CUSTODIAN 2:

SUPERVISORY ENTRY  
SUPERVISORY EXIT:

## ANNEXURE-5 OF CASH APPENDIX

### (D) CASH RECONCILIATION & REPELNISHMENT REPORT (C3R)

<b>FSS</b>																
Date :		Region :			Bank :			CIT :								
<b>C3R</b>	Denomination	Vault Op. Balance	Cash withdrawn from Bank	Total Cash in Cassettes	Total Purge Cash	Total Amt. Repld	Vault Closing Balance	Overages	Shortages							
	500			0	-	-	0	-	-							
	100			0	-	-	0	-	-							
<b>Total</b>		-	-	-	-	-	-	-	-							
<b>"CASH ADD METHOD"</b>																
Sl. No.	Particulars			Order No.	Den o	ATM Up. Balance (Prev Repl)	ATM amt Dispense	ATM Cash Position -			ATM	Total ATM Cash Position	Closing Balance in ATM	Overages	Shortages	Status
6	ATM Id	Location	Time					Cassettes	Seal No.	Purge Bin	Amount Replenished	Seal No.				
					500											
					100											
					<b>Total</b>	-	-	-	-	-	-	-	-	-	-	OK
7					500											
					100											
					<b>Total</b>	-	-	-	-	-	-	-	-	-	-	OK
8					500											
					100											
					<b>Total</b>	-	-	-	-	-	-	-	-	-	-	OK
9					500											
					100											
					<b>Total</b>	-	-	-	-	-	-	-	-	-	-	OK
10					500											
					100											
					<b>Total</b>	-	-	-	-	-	-	-	-	-	-	OK
Total (1)					500	-	-	-	-	-	-	-	-	-	-	
					100											
					<b>Total</b>	-	-	-	-	-	-	-	-	-	-	
Grand Total = Total (1) + Total (2)					500	-	-	-	-	-	-	-	-	-	-	
					100											
					<b>Total</b>	-	-	-	-	-	-	-	-	-	-	

**Note:**

1. This report has an Auto Error Check. If the Values entered are wrong then an "Alert" message will appear in the "Status" coloumn else "OK" will appear.
2. Do not Add or Delete any extra fields (Rows & Coloumns)
3. Discrepancies should be filled in the field provided in the sheet "Remarks"
4. Please double check the values entered before saving the file
5. All the Black fields are not to be modified
6. This main sheet can only carry maximum of 10 ATM's details. For Additional ATM's i.e., more than 10 ATM's, go to the sheet "Extra Rep".

### (E) OVERAGE & SHORTAGE REPORT (OSR)

<b>FSS</b>													
<b>Overages &amp; Shortages Report</b>										Date :	Bank :		
										CIT :	Region :		
<b>OSR</b>	Sl. No.	ATM ID	Location	Amount in Rs.		Journal Record						Remarks	
				Shortage	Overage	Date	Tsn Time	Tsn Amoun	TX#	RCD E#	Card No.	REFR #	
	1												
	2												
	3												
	4												
Total Overage in Rs :				<b>0</b>		Total Shortage in Rs :				<b>0</b>			

**Note:**

1. This main sheet can only carry maximum of 4 transaction details. For Addition i.e., more than 10 transactions, insert new rows in the same format.
2. Do not change the format of the fields provided. Type the values in the provided field.
3. Discrepancies should be filled in the field provided "Remarks"
4. Please double check the values entered before saving the file

© VAULT CLOSING BALANCE (VCB)

**FSS**

*Vault Closing Balance*

Date:	
Region:	
Bank:	
CIT:	

**VCB**

Sl. No.	Description	No. of Notes		Value in Rs.		
		100	500	100	500	Total
1	Vault Op. Balance			0	0	0
2	Withdrawal from Bank			0	0	0
3	Replenish to ATM			0	0	0
4	Cash Return			0	0	0
5	ATM Unfit Currency			0	0	0
6	Closing Balance	0	0	0	0	0
7	ATM Fit Currency	0	0	0	0	0

## ANNEXURE-6 OF CASH APPENDIX

To,

The Branch Manager,

State Bank of India,

-----

-----

(Address of Currency Notes issuing Branch)

Madam/ Dear Sir,

### CASH REPLENISHMENT IN ATM(S) UNDERTAKING LETTER

We undertake that we have received sorted and issuable cash from the Branch and cash is sorted through the Note Sorting Machine (NSM). We are responsible for disbursing any fake note in the particular ATM. We are solely responsible for any consequences or investigations on account of such incidence.

2. The denomination-wise number and value of Currency Notes are as under:

Face value Currency Notes	Numbers	Value (in ₹)
₹500		
₹200		
₹100		
₹50		
Reference No. BGL 3199842 (ATM Cash Intermediate Account)/ BGL 4599269 (Cash Point Cash Intermediate Account)		

Authorised Person\*

Joint Custodian I\*#

Joint Custodian II\*#

Name: \_\_\_\_\_

Branch/ Vendor Name:

Address:

Date:

(\*whichever is applicable; #applicable for ATM Joint Custodians)

\*\*\* end of Annexures of Cash Appendix \*\*\*

**5. PROJECT PLAN, DELIVERY AND SCHEDULE:**

**5.1. Testing of machine and piloting of tested Machines:**

X- The date of Letter of Intent (LOI).

Activity	Sub-Activity	No. of Calendar Days
Test Machine delivery	i. Delivery of test machines ( <del>one</del> endpoint machine(s) of one model of each OEM with atleast 2 Harddisks for each endpoint)  ii. UPS & atleast 8 hours back up fast charging SMF / Lithium-ion batteries for each machine  iii. All software(s) / drivers / OEM Native Applications / licenses etc. at IT-ATM Lab and thereafter in Live environment.  All Deliverables for testing mentioned in the RFP in Appendix-E.	Y = X + 10 calendar days
Testing of machines	Customization, Integration, testing etc. (including end to end UAT / SIT / Security Review etc.) by the successful bidders or their representatives (OEM of machine), with OEM Native Applications / Agents at test environment at IT-ATM Lab and thereafter in Live environment.  Scope of testing is mentioned in this RFP in Appendix-E..	Y + 90 calendar days
Pilot	Live Pilot Testing, Monitoring and Observations	Y + 105 calendar days

5.2. **Overall Rollout Plan details:**

- a) **Z = Overall Purchase Order (PO) date from Anytime Channels, Corporate Centre, after successful Live Pilot completion.**

Tranche	Tentative Rollout Number of units	Timelines in Days for Cash-live
I: Replacement of existing old BLA (MoF) and old TOM ATMs.	13,500	Z + 90

b) **Note:**

- i. **Site wise Bulk Purchase Order for replacement of old machines shall be issued by Anytime Channel Corporate Centre\_ and penalty for delayed cash-live of services will be calculated from this Purchase Order date.**
- ii. **For buffer quota ATMs or new ATM installations, the purchase order shall be issued by the respective Circles\_ and penalty for delayed cash-live of services will be calculated from the Purchase Order date\_.**
- iii. **The rollout schedule must be adhered to by the successful bidders, irrespective of the total number of successful bidders.**
- iv. **In case the entire procurement of the said services is allotted to L1 / single vendor then the vendor should be in position to roll out the total quantities as per the timelines mentioned above.**
- v. **Allocation of Circles among successful bidders will be done by the Bank at its sole discretion and will be binding on the successful bidders.**
- vi. **The Overall Rollout number of units within each tranche are tentative. The Bank reserves the right to change the number of units specified within Tranches without any overall change in the Total Allocated units to a successful bidder.**

5.3. **Tranche-wise Rollout Plan details:**

I. **Replacement of existing old BLA (MoF) and old TOM ATMs**

Tentative Rollout Number of units	Timelines in Days for Cash-live
3000	Z + 30
4500	Z + 60
6000	Z + 90
<b>Total: 13,500</b>	<b>In Z + 90</b>

II. **Tentative Allocation among Circles is as follows** (This list is illustrative only and actual numbers of machines can be varied as per Bank's requirement):

Sr. No.	CIRCLE	TOTAL UNITS
1	AHMEDABAD	690
2	AMARAVATI	70
3	BENGALURU	660
4	BHOPAL	2,550
5	BHUBANESHWAR	540
6	CHANDIGARH	1,500
7	CHENNAI	410
8	GUWAHATI	1,540
9	HYDERABAD	140
10	JAIPUR	1,140
11	KOLKATA	70
12	LUCKNOW	40
13	MAHARASHTRA	1,130
14	MUMBAI METRO	100
15	NEW DELHI	1,110
16	PATNA	1,250
17	THIRUVANANTHAPURAM	560
<b>GRAND TOTAL</b>		<b>13,500</b>



## 6. SECURITY:

- a) The vendor will be responsible for entire security including but not limited to the Physical, Digital, Cyber etc. of Endpoints, allied equipment (s), sites, cash, data, Information etc.
- b) Vendor should use the latest tools & gadgets to curb potential loss / frauds, without any cost to the Bank. Any tools / gadgets related to IT infrastructure should be implemented only after duly testing and approval by the Bank's IT Dept.

## 7. MIS REPORTS:

- a) Vendor should provide any MIS Report sought by the Bank during the contract period and extension(s) thereof, within the timeframe specified by the Bank, at no cost to the Bank.
- b) Vendor shall assist in meaningful analysis of performance for improving uptime and availability of Endpoints.
- c) Vendor shall have to translate dynamically, the status information of all machines in the network / MIS as seen through their Management Centre into web pages, which can be accessed by Bank's Users Role based, if required. The summarized data provided by Vendor on the Web Server shall be classifiable at Multiple levels such as machine-wise, LHO wise, Zonal Office wise etc. or as may be intimated by Bank.
- d) Vendor shall furnish the Standard Report promptly including exceptions for SLAs of all connected service providers along with their stipulated periodicity as appended below which Bank may at its discretion add to / delete from the list:

Sl. No.	Reports	Description
<b>MONTHLY</b>		
1.	Availability Report	Availability trend analysis, causes of down-time, chronic Endpoints, action plan for improving availability (mapped LHO / Module wise)
2.	Consolidated Cash Out Report with cause and TAT analysis	Monthly with machine ID, date and reasons
3.	Consolidated Report on machines down	Due to hardware fault, network problem and spares not available with reasons.
4.	Analysis of cash forecasting recommendations	No. of occasions machines went out of cash despite providing cash in time as per recommendations.
5.	Consolidated Reports on calls (with TAT)	Region-wise report of calls per machine

Sl. No.	Reports	Description
6.	Report on Service Calls	Region-wise report on service calls per site for kiosk repairs and maintenance
7.	Report on Site Condition	Report on condition of kiosks, repairs necessary/undertaken.
8.	Report on Chronic faults	Machines down repeatedly for same reason
<b>FORTNIGHTLY</b>		
9.	Consolidated Exception Report	Consolidated list of machines which were out-of-service for more than 4 hours for each instance, with downtime break up and the reasons with remedial plans.
10.	Performance Report on VIP Machines	Availability analysis of 'VIP Machines' with reasons for downtime.
<b>WEEKLY</b>		
11.	Report on Factor of Safety (FoS)	Circle-wise weekly report along with daily closing balance in each machine.
<b>Daily</b>		
12.	Report on downtime on account of Third-Party Components	Report to ensure previous day's faults have been properly escalated, followed up and rectified within the stipulated timelines.
13.	24 / 48 hours Down Report	List of machines out of service for 24 / 48 hours with downtime break up and reasons.
14.	Current State Reports (thrice a day)	Status of machines during the day
15.	Urgent Actionable Information	Urgent actionable information on cash out, cash jams, cash handler, low currency cassette etc, through SMS
16.	Cash Recommendations	Recommendations for optimum amount of cash to be loaded to avoid cash outs and idle cash.
17.	Consolidated Cash Recommendations	Consolidated list of all cash recommendations sent to branches.
18.	Cash Recommendations Not Followed	List of machines which went out of cash on account of non-adherence to cash recommendations sent.
19.	Daily FOS report (Circle wise)	Machine-ID wise FoS Report with details of cash dispensed, opening balance, cash replenished and cash evacuated.
<b>On Demand</b>		
20.	Cash Out Report	Incidents of Cash Out
21.	Hourly Current Status report	Current status on demand in crises like Bank strike, rains, floods, regulatory requirement etc
22.	Ticket History Report	For chronically ailing Endpoints
23.	Any other report	As and when required.

**Appendix-F:**  
**INDICATIVE COMMERCIAL PRICE BID FORMATS**

(All subparts to be provided in separate sealed cover physically as well as online)

**F1: PRICE BID FORMAT: -**

**SERVICES OF 13,500 ATMs UNDER TOTAL OUTSOURCED MODEL (TOM) ON PER SUCCESSFUL TRANSACTION BASIS**

NAME OF THE BIDDER: \_\_\_\_\_

PRICE BID FOR SERVICES OF 13,500 OFFSITE ATMs UNDER TOTAL OUTSOURCED MODEL (TOM) ON PER SUCCESSFUL TRANSACTION RATE BASIS						
Sl. No.	Per Successful Transaction Offsite ATM	Number of ATMs	Number of Transactions (Estimated)	Fixed Criteria, if any	Rate to be Quoted by Bidder (Excluding Tax)	Total Computed Cost for 7 years (2557 days) (Excluding Taxes) (paisa upto two decimal)
1						
1. (a)	Financial	13,500	150	"A"	₹ 0.00	₹ 0.00
1. (b)	Non-Financial	13,500	50	B = 25% of A	₹ 0.00	₹0.00
<b>TOTAL COST OF OWNERSHIP (TCO) FOR 13,500 ATMs</b>						<b>₹ 0.00</b>
Optional Services under Sl. No. 2 (Not to be included in TCO)						
2	Items	Additional Per Successful Transaction Offsite ATM		Fixed Criteria	Rate to be Quoted by Bidder (Excluding Tax)	Total Additional Cost for 7 years (2557 days) (Excluding Taxes) (paisa upto two decimal)
2. (a)	Housekeeping Services	Financial		C = 2% of A	₹ 0.00	₹0.00
2. (b)		Non-Financial		D = 2% of B	₹ 0.00	₹0.00
2. (c)	External Digital Signage Solutions (EDSS)	Financial		E = 3%-5% of A	₹ 0.00	₹0.00
2. (d)		Non-Financial		F = 3% 5% of B	₹ 0.00	₹0.00
<b>Total Cost for Optional Services</b>						<b>₹0.00</b>
<p><b>Note: 1.</b> ₹ 0.00 Rate to be quoted by Bidder (excluding Tax) while submitting Commercial Bids. <b>Reverse Auction will be carried out at item mentioned against "A" and "B"; however, "B" shall be fixed as 25% of "A".</b> All other line items under Serial No. 2 shall be derived as mentioned above. Selected Vendors (L2 /L3 / L4 ...) have to match all line items mentioned against A, B, C, D, E, F of L1.</p> <p><b>2.</b>TCO shall be calculated considering 150 (one hundred fifty) Successful Financial Transactions per ATM per day @ discovered rate i.e., "A" as per price bid and 50 (fifty) Non-Financial transactions @ derived rate per ATM per day from "A" (Fix 25% of "A") as per price bid i.e., "B" for 13,500 Offsite ATMs for 7 years (2557 Days).</p>						
Name & Signature of authorised signatory with Seal of Company						

## F2: TAX RATE

**SERVICES OF 13500 ATMs UNDER TOTAL OUTSOURCED MODEL (TOM) ON PER SUCCESSFUL TRANSACTION BASIS**

**NAME OF THE BIDDER:** \_\_\_\_\_

Services	Tax 1	Tax 2 (if any)	Tax 3 (if any)
<b>SERVICES OF 13500 ATMs UNDER TOTAL OUTSOURCED MODEL (TOM) ON PER SUCCESSFUL TRANSACTION BASIS</b>	<b>Name of Tax:</b> GST	<b>Name of Tax:</b> _____	<b>Name of Tax:</b> _____
	<b>Tax %:</b> _____	<b>Tax %:</b> _____	<b>Tax %:</b> _____

**Name & Signature of authorised signatory with Seal of Company**

### F3: TCO CALCULATION

TCO shall be calculated considering 150 (one hundred fifty) Successful Financials Transactions @ discovered rate i.e., “A” as per price bid and 50 (fifty) Non-Financial transactions @ derived rate from “A” as per price bid i.e., “B” at Offsite ATMs.

All Bidders have to compute their expected TCO based on their quoted rates in F1 “PRICE BID FORMAT” as per the calculation method illustrated below:

#### SERVICES OF 13,500 ATMs UNDER TOTAL OUTSOURCED MODEL (TOM) ON PER SUCCESSFUL TRANSACTION BASIS

NAME OF THE BIDDER: \_\_\_\_\_

TCO is the Total Cost of Ownership of the project, computed for 7 years (2557 Days).

#### TCO CALCULATION ONLY FOR ILLUSTRATION PURPOSE: -

- i. Assumption @ Rs. 50 PER SUCCESSFUL TRANSACTION RATE;
- ii. Offsite ATMs 13,500 ATM;
- iii. Considering 200 Txn per day per ATM for Offsite ATM, considering 150 Txns. are financial and 50 are non-financial;
- iv. Total Contract Period 7 years (2557 days).

TCO ILLUSTRATION @ RS.50 PER TRANSACTION RATE			
Type of Site	OFFSITE		
Number of Machines	13,500		
<b>Type of Transaction</b>	<b>FINANCIAL</b>	<b>NON-FINANCIAL</b>	<b>GRAND TOTAL</b>
NUMBER OF TRANSACTIONS PER ATM PER DAY	150	50	200
PER TRANSACTION RATE	₹ 50.00	₹ 12.50	
COST PER ATM PER DAY	₹ 7,500.00	₹ 625.00	₹ 8,125.00
DAYS IN 7 YEARS	2557	2557	2557
TOTAL COST FOR 13,500 ATMs IN SEVEN YEARS (2557 DAYS) (₹ in Crores)	25,889.63	2,157.47	28,047.09

“There will be monthly billing based on the number of successful Financial and Non-financial transactions in that month multiplied by respective per transaction rates. The payment shall be done in subsequent month(s), after computation of applicable penalties, if any.”

Name & Signature of authorised signatory with Seal of Company

## **Appendix–G and Appendix-G1**

### **APPENDIX-G**

### **Certificate of Local Content**

**(To be submitted for each OEM's ATM)**

*In case of companies, Certificate from the statutory auditor / cost auditor of the company (with Registration Number with seal) and counter-signed by Company Secretary and Certificate counter-signed by Bidder giving the percentage of local content, on their letter head.*

*In respect of suppliers other than companies, Certificate from a practicing cost accountant (with Registration Number with seal) / practicing chartered accountant (with Registration Number with seal), and Certificate counter-signed by Bidder giving the percentage of local content, on their letter head.*

Date:

The Deputy General Manager (I&R),  
State Bank of India,  
Corporate Centre,  
Anytime Channels Dept.,  
3<sup>rd</sup> Floor, World Trade Centre "Arcade",  
Cuffe Parade, Mumbai – 400005.

Dear Sir,

**Ref.: RFP No.: SBI/AC/2023-24/003 dated: 17/08/2023.**

1. This is to certify that proposed ATM model \_\_\_\_\_ <OEM & model name> has the local content of \_\_\_\_\_ % as defined in the above-mentioned RFP and amendment thereto.

2. This certificate is submitted in reference to the Public Procurement (Preference to Make in India), Order 2017 – Revision vide Order No. P-45021/2/2017-PP (BE-II) dated May 28, 2018 -Revision order No. P-45021/2/2017-PP (BE-II) dated 16.09.2020 and as per subsequent guidelines issued by Govt of India procurement manual updated up to June 2022 and clarification office memorandum 04<sup>th</sup> March, 2021.

<b>counter-signed: Bidder</b>	<b>Signature of Statutory Auditor / Cost Auditor</b>  Registration Number:	<b>Counter Signed: Company Secretary*</b>

(\* Wherever company secretary is not applicable, Chairman/MD may counter sign)

< Certified copy of board resolution for appointment of statutory/cost auditor and company secretary should also be enclosed with the certificate of local content.>

## Appendix-G1 Format for Self-Certification of Local Content

To,

---

---

---

Dear Sir,

**Ref.: RFP No.: SBI/AC/2023-24/003 dated: 17/08/2023**

1. This is to certify that proposed ATM model(s) \_\_\_\_\_ <OEM & model name> is having the local content of \_\_\_\_\_ % \_\_\_\_\_ %, respectively. As defined in the above-mentioned RFP, we hereby classify ourselves as **Class-I Local Supplier / Class-II Local Supplier** / <mention the applicable class category>.

1. The details of location(s) at which the local value addition is made are as under:

Sl. No.	Product details	Name of place (In India only)
1		
2		

3. This certificate is submitted in reference to the Public Procurement (Preference to Make in India), Order 2017 – Revision vide Order No. P-45021/2/2017-PP (BE-II) dated May 28, 2018 -Revision order No. P-45021/2/2017-PP (BE-II) dated 16.09.2020 and as per subsequent guidelines issued by Govt of India procurement manual updated upto June 2022 and clarification office memorandum 04<sup>th</sup> March, 2021 regarding non-local suppliers in respect of imported products.

<b>counter-signed:</b> <b>Bidder</b>	<b>Signature of Statutory Auditor/Cost Auditor</b> Registration Number:	<b>Counter Signed:</b> <b>Company Secretary*</b>
<b>Seal</b>	<b>Seal</b>	<b>Seal</b>

(\* Wherever company secretary is not applicable, Chairman/MD may counter sign)

**Appendix-H**  
**BANK GUARANTEE FORMATS**

H1: EMD BANK GUARANTEE FORMAT

H2: PERFORMANCE BANK GUARANTEE FORMAT

H3: BANK GUARANTEE FOR CASH HANDLING SERVICES

**FORMAT H1**  
**FORMAT FOR EMD BANK GUARANTEE**

To:

-----  
-----

Dear Sir,

**EMD BANK GUARANTEE FOR STATE BANK OF INDIA  
TO PROVIDE "SERVICES FOR ATMS UNDER TOTAL OUTSOURCED MODEL  
(TOM) ON PER SUCCESSFUL TRANSACTION BASIS"  
AS ARE SET OUT IN THE RFP no. SBI/AC/2023-24/003 dated: 17/08/2023**

WHEREAS **State Bank of India**, a Statutory Corporation constituted under the State Bank of India Act, 1955 having its Corporate Centre at SBI Bhawan, Madame Cama Road, Nariman Point, Mumbai 400021 and one of its offices at **Anytime Channels, Corporate Centre, World Trade Centre, Cuffe Parade, Mumbai 400005** (procuring office address), (hereinafter referred to as "SBI" which expression shall, unless repugnant to the subject, context or meaning thereof, be deemed to mean and include its successors and assigns) has invited Request for Proposal for **SERVICES FOR ATMS UNDER TOTAL OUTSOURCED MODEL (TOM) ON PER SUCCESSFUL TRANSACTION BASIS** as are set out in the Request for Proposal **SBI/AC/2023-24/003 dated: 17/08/2023**

It is one of the terms of said Request for Proposal that the Bidder shall furnish a Bank Guarantee for a sum of **Rs. 2,00,00,000 /- (Rupees Two Crore Only)** as Earnest Money Deposit.

M/s. \_\_\_\_\_, (hereinafter called as Bidder, who has agreed to provide Services of ATMs on per successful transaction rate basis under Total Outsourced Model (TOM) (hereinafter referred to as "Services") to SBI in accordance with the Request for Proposal (RFP) No. **SBI/AC/2023-24/003 dated: 17/08/2023** and intends to submit their Bid for the said work and have requested us to furnish guarantee in respect of the said sum of **Rs. 2,00,00,000 /- (Rupees Two Crore Only)**

**NOW THIS GUARANTEE WITNESSETH THAT**



- 1) We \_\_\_\_\_ (Bank) do hereby agree with and undertake to the State Bank of India, their Successors, assigns that in the event of the SBI coming to the conclusion that the Bidder has not performed their obligations under the said conditions of the RFP or have committed a breach thereof, which conclusion shall be binding on us as well as the said Bidder, we shall on demand by the SBI, pay without demur to the SBI, a sum of **Rs. 2,00,00,000 /- (Rupees Two Crore Only)** that may be demanded by SBI. Our guarantee shall be treated as equivalent to the Earnest Money Deposit for the due performance of the obligations of the Bidder under the said conditions, provided, however, that our liability against such sum shall not exceed the sum of **Rs. 2,00,00,000 /- (Rupees Two Crore Only)**.
- 2) We also agree to undertake to and confirm that the sum not exceeding **Rs.2,00,00,000/- (Rupees Two Crore Only)** as aforesaid shall be paid by us without any demur or protest, merely on demand from the SBI on receipt of a notice in writing stating the amount is due to them and we shall not ask for any further proof or evidence and the notice from SBI, shall be conclusive and binding on us and shall not be questioned by us in any respect or manner whatsoever. We undertake to pay the amount claimed by the SBI within 24 hours from the date of receipt of the notice as aforesaid. We confirm that our obligation to the SBI under this guarantee shall be independent of the agreement or agreements or other understandings between SBI and the Bidder. This guarantee shall not be revoked by us without prior consent in writing of the SBI.
- 3) We hereby further agree that –
- a. Any forbearance or commission on the part of the SBI in enforcing the conditions of the said agreement or in compliance with any of the terms and conditions stipulated in the said Bid and / or hereunder or granting of any time or showing of any indulgence by the SBI to the Bidder or any other matter in connection therewith shall not discharge us in any way our obligation under this guarantee. This guarantee shall be discharged only by the performance of the Bidder of their obligations and in the event of their failure to do so, by payment to us of the sum not exceeding **Rs. 2,00,00,000 /- (Rupees Two Crore Only)**.
  - b. Our liability under these presents shall not exceed the sum of **Rs. 2,00,00,000/- (Rupees Two Crore Only)**.
  - c. Our liability under this agreement shall not be affected by any infirmity or irregularity on the part of our said constituents in tendering for the said work or their obligations there under or by dissolution or change in the constitution of our said constituents.
  - d. This guarantee shall remain in force upto **12 months 180 days** provided that if so desired by the SBI, this guarantee shall be renewed for a further period as may be indicated by them on the same terms and conditions as contained herein.

- e. Our liability under this presents will terminate unless these presents are renewed as provided herein upto ~~12-months~~ 180 days or on the day when our said constituents comply with their obligations, as to which a certificate in writing by the SBI alone is the conclusive proof, whichever date is later.
  
- f. Unless a claim or suit or action is filed against us within ~~12-months~~ 180 days from that date or any extended period, all the rights of the SBI against us under this guarantee shall be forfeited and we shall be released and discharged from all our obligations and liabilities hereunder.
  
- g. This guarantee shall be governed by Indian Laws and the Courts in Mumbai, India alone shall have the jurisdiction to try & entertain any dispute arising out of this guarantee.

**Notwithstanding anything contained hereinabove:**

- a. Our liability under this Bank Guarantee shall not exceed **Rs. 2,00,00,000/- (Rupees Two Crore Only)**.
  
- b. This Bank Guarantee shall be valid upto .....
  
- c. We are liable to pay the guaranteed amount or any part thereof under this Bank Guarantee only and only if SBI serve upon us a written claim or demand on or before .....

Yours faithfully,

For and on behalf of

\_\_\_\_\_  
Authorized official.

(Note: This guarantee will require stamp duty as applicable in the State where it is executed and shall be signed by the official(s) whose signature and authority shall be verified).

## FORMAT H2: PERFORMANCE BANK GUARANTEE FORMAT:

### PERFORMANCE BANK GUARANTEE

*(TO BE STAMPED AS AN AGREEMENT)*

**THIS PERFORMANCE BANK GUARANTEE AGREEMENT** BANK executed at .....this..... day of ..... 2023 by ..... (Name of the Bank) ..... having its Registered Office at .....and its Branch at .....(hereinafter referred to as "**the Guarantor**", which expression shall, unless it be repugnant to the subject, meaning or context thereof, be deemed to mean and include its successors and permitted assigns) **IN FAVOUR OF State Bank of India**, a Statutory Corporation constituted under the State Bank of India Act, 1955 having its Corporate Centre at SBI Bhawan, Madame Cama Road, Nariman Point, Mumbai 400021 and one of its offices at **Anytime Channels, Corporate Centre, World Trade Centre, Cuffe Parade, Mumbai 400005 (procuring office address)**, (hereinafter referred to as "**SBI**" which expression shall, unless repugnant to the subject, context or meaning thereof, be deemed to mean and include its successors and assigns).

WHEREAS M/s \_\_\_\_\_, incorporated under \_\_\_\_\_ Act having its registered office at \_\_\_\_\_ and principal place of business at \_\_\_\_\_ (hereinafter referred to as "**Service Provider/ Vendor**" which expression shall unless repugnant to the context or meaning thereof shall include its successor, executor & assigns) has agreed to provide services through its hardware / software and to develop, implement & support Services of ATMs on per successful transaction rate basis under Total Outsourced Model (TOM) (hereinafter referred to as "**Services**") to SBI in accordance with the Request for Proposal (RFP) No. **SBI/AC/2023-24/003 dated: 17/08/2023**.

WHEREAS, SBI has agreed to avail the Services from the Service Provider for a period of 7 years, and which can be extended upto 10 years (i.e., upto another three years in one or more tranches after base 7 years period) at sole discretion of SBI.

WHEREAS, in accordance with terms and conditions of the said RFP / Purchase order / Agreement dated....., Service Provider is required to furnish a Bank Guarantee for a sum of Rs. \_\_\_\_\_/- (Rupees \_\_\_\_\_ only) for due performance of the obligations of the Service Provider in providing the Services, in accordance with the RFP / Purchase order / Agreement guaranteeing payment of the said amount of Rs. \_\_\_\_\_/- (Rupees \_\_\_\_\_ only) to SBI, if Service Provider fails to fulfil its obligations as agreed in RFP / Agreement.

WHEREAS, the Bank Guarantee is required to be valid for a total period of **96 months** and in the event of failure, on the part of Service Provider, to fulfil any of its commitments / obligations under the RFP / Agreement, SBI shall be entitled to invoke the Guarantee.

AND WHEREAS, the Guarantor, at the request of Service Provider, agreed to issue, on behalf of Service Provider, Guarantee as above, for an amount of Rs. \_\_\_\_\_/- (Rupees \_\_\_\_\_ only).

**NOW THIS GUARANTEE WITNESS THAT**

1. In consideration of SBI having agreed to entrust the Service Provider for rendering Services as mentioned in the RFP, we, the Guarantors, hereby unconditionally and irrevocably guarantee that Service Provider shall fulfil its commitments and obligations in respect of providing the Services as mentioned in the RFP / Agreement and in the event of Service Provider failing to perform / fulfil its commitments / obligations in respect of providing Services as mentioned in the RFP / Agreement, we (the Guarantor) shall on demand(s), from time to time from SBI, without protest or demur or without reference to Service Provider and notwithstanding any contestation or existence of any dispute whatsoever between Service Provider and SBI, pay SBI forthwith the sums so demanded by SBI in each of the demands, subject to a cumulative maximum amount of Rs. \_\_\_\_\_/- (Rupees \_\_\_\_\_ only).
2. Any notice / communication / demand from SBI to the effect that Service Provider has failed to fulfil its commitments / obligations in respect of rendering the Services as mentioned in the Agreement, shall be conclusive, final & binding on the Guarantor and shall not be questioned by the Guarantor in or outside the court, tribunal, authority or arbitration as the case may be and all such demands shall be honoured by the Guarantor without any delay.
3. We (the Guarantor) confirm that our obligation to the SBI, under this guarantee shall be independent of the agreement or other understandings, whatsoever, between the SBI and the Service Provider.
4. This guarantee shall not be revoked by us (the Guarantor) without prior consent in writing of the SBI.

**WE (THE GUARANTOR) HEREBY FURTHER AGREE & DECLARE THAT-**

- i. Any neglect or forbearance on the part of SBI to Service Provider or any indulgence of any kind shown by SBI to Service Provider or any change in the terms and conditions of the Agreement or the Services shall not, in any way, release or discharge the Bank from its liabilities under this Guarantee.
- ii. This Guarantee herein contained shall be distinct and independent and shall be enforceable against the Guarantor, notwithstanding any Guarantee or Security now or hereinafter held by SBI at its discretion.

- iii. This Guarantee shall not be affected by any infirmity or absence or irregularity in the execution of this Guarantee by and / or on behalf of the Guarantor or by merger or amalgamation or any change in the Constitution or name of the Guarantor.
- iv. The guarantee shall not be affected by any change in the constitution of SBI or Service Provider or winding up / liquidation of Service Provider, whether voluntary or otherwise.
- v. This guarantee shall be a continuing guarantee during its validity period and the SBI can make its claim in one or more events within the total liability of the Guarantor mentioned herein.
- vi. This Guarantee shall remain in full force and effect for a period of **96 months** from the date of the issuance i.e. up to \_\_\_\_\_ << *validity (including claim period)* >>. Unless a claim under this Guarantee is made against us within the validity (including claim period) from that date i.e. on or before \_\_\_\_\_ <<*validity (including claim period)*>>, all your rights under this Guarantee shall be forfeited and we shall be relieved and discharged from all liabilities there under.
- vii. This guarantee shall be governed by Indian Laws and the Courts in Mumbai or the place of execution of documents, India alone shall have the jurisdiction to try & entertain any dispute arising out of this guarantee.

Notwithstanding anything contained herein above:

- a) Our liability under this Bank Guarantee shall not exceed Rs...../- (Rupees ..... only).
- b) This Bank Guarantee shall be valid up to....., including the claim period.
- c) We are liable to pay the guaranteed amount or any part thereof under this Bank Guarantee only and only if SBI serve upon us a written claim or demand on or before .....i.e., the validity date (including the claim period).

Yours faithfully,

For and on behalf of Bank.

\_\_\_\_\_  
Authorized official

**FORMAT H3:**  
**BANK GUARANTEE FOR CASH HANDLING**  
**SERVICES FORMAT**

**BANK GUARANTEE FOR CASH HANDLING SERVICES**

*(TO BE STAMPED AS AN AGREEMENT)*

This Guarantee is made at \_\_\_\_\_ <place> on this \_\_\_\_ day of \_\_\_\_\_, 2023 by \_\_\_\_\_, having its Registered / Head Office at \_\_\_\_\_ (hereinafter called the "Bank", which expression shall, unless repugnant to the context or meaning thereof, shall mean and include, its successors and assigns) **IN FAVOUR OF State Bank of India**, a Statutory Corporation constituted under the State Bank of India Act, 1955, having its Corporate Centre at SBI Bhawan, Madame Cama Road, Nariman Point, Mumbai 400021 and one of its offices at \_\_\_\_\_ **(LHO address)**, (hereinafter referred to as "**SBI**" which expression shall, unless repugnant to the subject, context or meaning thereof, be deemed to mean and include its successors and assigns).

WHEREAS \_\_\_\_\_, having its registered office at \_\_\_\_\_ and its corporate office at \_\_\_\_\_ (hereinafter called the "**Vendor**" which expression shall unless repugnant to the context or meaning thereof shall mean and include its successor and assigns), has entered into Agreement for Services of ATMs on per successful transaction rate basis under Total Outsourced Model (TOM) dated \_\_\_\_\_ with **SBI** (hereinafter referred to as the **TOM Phase-XVII** Agreement) whereby \_\_\_\_\_ has agreed to provide services as per the said Agreement.

AND WHEREAS under the **TOM Phase-XVII Agreement**, \_\_\_\_\_ <<Vendor name>> has, inter-alia, agreed to provide Cash Handling Services upon the terms and conditions stated in the **SBI/AC/2023-24/003 dated: 17/08/2023** as "**Cash Replenishment / Cash Evacuation Services**".

AND WHEREAS in accordance with clause of Cash Appendix, Vendor is required to furnish a Bank Guarantee for the sum of Rs. \_\_\_\_\_/- (Rupees \_\_\_\_\_ only) securing its obligations in respect of cash losses in machines, in vaults and in-transit while providing the Cash Services in accordance with the terms of RFP / SLA. Such Bank Guarantee is required to be valid till the validity of the **96 months** i.e., till \_\_\_\_\_. In the event of failure on the part of Vendor to pay for cash losses as per the terms and conditions of the Cash Appendix, SBI shall be entitled to invoke the guarantee.

AND WHEREAS the Bank at the request of Vendor agreed to issue in favour of SBI this guarantee for Rs. \_\_\_\_\_/- (Rupees \_\_\_\_\_ only).

**IN CONSIDERATION OF THE ABOVE PREMISES**

1.(a) We \_\_\_ Bank shall on written demand(s) from time to time from SBI stating that the amount claimed is due by way of cash loss suffered by the SBI without protest or demur or without reference to Vendor and notwithstanding any contestation or existence of any dispute whatsoever between Vendor and SBI, pay to SBI forthwith the sums so demanded by Bank in each of its demands, not exceeding an aggregate amount of Rs. Rs. ....../- (Rupees ..... only).

(b) Any notice / communication / demand from SBI to the effect that there has been failure on the part of Vendor to fulfil its obligations to pay for the Cash Loss under the Cash Services Appendix shall be conclusive, final and binding on the Bank and shall not be questioned by the Bank, in or outside the court, tribunal, authority or arbitration as the case may be.

(c) This guarantee shall be a continuing guarantee during its currency.

2. We, \_\_\_\_\_ Bank, HEREBY FURTHER AGREE & DECLARE THAT:

- a. Any neglect or forbearance on the part of SBI to Vendor or any indulgence of any kind shown by SBI or any change in the terms & conditions of the said Cash Services Annexure shall not in any way release or discharge the Bank from its liabilities under this guarantee.
- b. This guarantee herein contained shall be distinct and independent and shall be enforceable against the Bank, notwithstanding any Guarantee or Security now or hereinafter held by SBI at its discretion.
- c. This guarantee shall not be affected by any infirmity or absence or irregularity in the exercise of the guaranteeing powers by or on behalf of the Bank or by merger or amalgamation or any change in the constitution or name of the Bank.
- d. This guarantee shall not be affected by any change in the constitution of SBI or Vendor or winding up / liquidation of Vendor, whether voluntary or otherwise.
- e. SBI can make its claim in one or more events within the total liability of the Bank.

f. Notwithstanding anything contained herein:

- (i) Bank's liability under this Bank Guarantee shall not exceed Rs. ....../- (Rupees ..... only).
- (ii) This Bank Guarantee shall be valid for **96 months** i.e., from (date) \_\_\_\_\_ to (date) .....; and
- (iii) The Bank is liable to pay the guaranteed amount or any part thereof under this Bank Guarantee only and only if SBI serves the Bank claim or demand on or before ..... (the expiry of this BG).
- (iv) The guarantor, under its constitution, has powers to give this guarantee and Shri \_\_\_\_\_ (signatories) Official(s) / Manager(s) of the Bank who has / have signed this guarantee has / have powers/authority to do so.

IN WITNESS WHEREOF THE Bank has caused these presents to be signed at the place and on the date, month & year first herein above written through its duly authorised official.

Yours faithfully,

For and on behalf of Bank.  
Authorized official

## Appendix-I

### PENALTIES & INCENTIVES

#### **1. GENERAL:**

- 1.1. All billings will be on monthly basis in arrears for each Circle and payment shall be made by the respective Circles. The Bank may opt for a Centralized Bill Payment approach from its Corporate Centre instead of Circles.
- 1.2. In case where penalty amount cannot be serviced through payment being made to successful bidder(s), penalty will be paid by the successful bidder(s) through a cheque within 15 days from the close of the quarter. If the successful bidder(s) fails to pay, the Bank may realize the penalty amount by either invoking the BG submitted by them or recovering from any other payment due to them.
- 1.3. Computation of all penalties at the Local Head Office level. All penalties shall be recovered concurrently at the LHO level from the total bill payable to the Vendor for the particular month, subject to the maximum of 35% of the bill payable. This cap of 35% shall not be applicable on Actual loss to Bank, transition penalty, e-Surveillance penalty, EDSS Penalty, Housekeeping penalty and for such item's penalty can be charged and recovered from Vendor beyond 35%.
- 1.4. No penalties shall be levied for delays not attributable to Vendor or delays on account of uncontrolled circumstances which shall be decided by the Bank and shall be binding on the Vendor.
- 1.5. Vendor shall submit the reason for delays on account of Bank dependencies via email twice a week for verification and confirmation by the Bank.
- 1.6. In case the penalties levied on the vendor are more than 35% in any Circle for a consecutive period of six months then the bank has the right to terminate the services of the vendor from that particular Circle.
- 1.7. The vendor shall submit the required credit note as advised by the Bank for the penalties imposed for deficiencies in the services, within 7 days from the date of intimation by the Bank. In case on non-submission of the credit note, the Bank shall proceed with the payment of the submitted invoices after deducting the penalties without any recourse to the vendor. However, the vendor should submit his claim regarding disputed transaction (if any) in writing within 30 days of the payment received by the vendor. The claim shall not be entertained by the Bank thereafter. The decision of the Bank will be final and binding on the vendor.



1.8. If the machine is not cash-live within 30 days at metro areas and 40 days at Rural / semi-Urban / Urban areas from the date of Purchase order placed by respective circles, and the reason for delay is not attributable to the Bank, the vendor will be liable to pay a penalty of ~~Rs. 5,000/-~~ ₹1,000/- per machine per day from 31<sup>st</sup> day for metro and urban / 41<sup>st</sup> day for other areas, which will be realized/recovered from the vendor from their invoices. In case of any delay due to Bank dependency, the vendor has to advise the same in writing along with the necessary proof mentioning the cause of delay.

1.9. Vendors have to adhere to the rollout plan mentioned in the RFP document or communicated by the Bank through email / letter. Further, the site sourcing exercise has to be completed within a reasonable period as communicated by the circle authorities / deployment plan mentioned in the RFP document else a penalty of Rs. 100 per day per ATM shall be applicable. Bank however has the discretion to review the penalty.

**1.10. Any penalty mentioned anywhere in this RFP / SLA, but not specifically mentioned in Appendix-I (Penalties & Incentives), shall also applicable and binding to the Vendor.**

## **2. MACHINE AVAILABILITY:**

2.1. Bank desires to provide world-class services at its ATMs with high 24 x 7 x 365 availability to customers. The Bidder is, therefore, expected to maintain atleast the targeted availability at all levels as stipulated by the Bank in subsequent paragraphs.

2.2. Bank's Online Monitoring Tools and their web login access will be extended to Bidder's Management Centre to know the status of endpoint real-time and prompt action is required to be taken by Management Centre based on the faults in the Online Monitoring Tools.

2.3. The Bidder to publish monthly availability report based on the Online Monitoring Tool Circle-wise and Bank as whole.

2.4. The Bidder will have to maintain availability at individual endpoint level.

2.5. Total time when endpoint was supporting cash withdrawal depending on the nature of the ATM will be considered "available".

2.6. There will be no exclusion to availability, except force majeure and vandalism cases.

2.7. The endpoints have been classified into two different categories – VIP endpoints and Regular endpoints:

Category	Minimum targeted Uptime / Availability per month
VIP- endpoints	98%
Regular endpoints	96% 95%

**2.8. Penalty for not maintaining the target availability:**

2.8.1. The Bidder will have to achieve the availability targets for endpoints at individual level - VIP endpoints and the Regular Endpoints. The penalty for not maintaining target availability will be applicable for individual Endpoint level.

2.8.2. “**Charges Payable**” defined as, the total amount to be paid for that month for that endpoint = number of successful Financial and non-financial transactions of that month multiplied by the respective per successful transaction rate MINUS (deduction) of applicable penalties, if any, for that endpoint.

**2.8.3. VIP endpoints**

Availability	Penalty Amount
95% to less than 98%	5% of Charges Payable
92% to less than 95%	10% of Charges Payable
Less than 92%	25% of Charges Payable

**2.8.4. Regular endpoints:**

Availability	Penalty Amount
93% to less than 96% 95%	5% of Charges Payable
90 % to less than 93%	10% of Charges Payable
Less than 90%	25% of Charges Payable

**2.9. Incentive for maintaining Higher Uptime / Transactions:**

2.9.1. The incentives will be applicable for individual Endpoints level, to be paid to the bidders over and above the “**Charges Payable**” defined in this RFP.

**2.9.2. VIP endpoints:**

Availability of Total Hits	Incentive Amount
If the monthly average availability of the machine is greater than or equal to <b>98%</b>	7% of the Charges payable
<p><b>Else</b> Irrespective of Availability, if the monthly average Total hits per day of the machine is:</p>	
Greater than or equal to 500	7% of the Charges Payable
Greater than or equal to 400 but less than 500	6% of the Charges Payable
Greater than or equal to 300 but less than 400	5% of the Charges Payable
Greater than or equal to 250 but less than 300	3% of the Charges Payable
<p>Note:</p> <ul style="list-style-type: none"> <li data-bbox="379 920 1396 1084">i. For machines falling into both criteria, the incentive percentage will be the sum of both percentages. E.g., A machine with <b>98%</b> availability and the monthly average Total hits per day of 500, the incentive % will be 7%+7% = 14%.</li> <li data-bbox="379 1133 1396 1207">ii. Total Hits includes Financial and non-financial transactions as defined in this RFP.</li> </ul>	

### 2.9.3. Regular Endpoints:

Availability or Total Hits	Incentive amount
If the monthly average availability of the machine is greater than equal to <del>96%</del> 95% and Monthly Average Total hits of that machine is greater than equal to 200.	7% of the Charges payable
<b>Else:</b> Irrespective of Availability, if the monthly average Total hits per day of the machine is:	
Greater than equal to 500	7% of the Charges Payable
Greater than equal to 400 but less than 500	6% of the Charges Payable
Greater than equal to 300 but less than 400	5% of the Charges Payable
Greater than equal to 250 but less than 300	3% of the Charges Payable
Note:	
i. for machines falling into both criteria, the incentive percentage will be the sum of both percentages. E.g., A machine with <del>96%</del> 95% availability and the monthly average Total hits per day of 500, the incentive% will be 7%+7%= 14%.	
ii. Total Hits includes Financial and non-financial transactions as defined in this RFP.	

### 3. MANAGED SERVICES:

3.1. Vendor shall provide First Line Maintenance (FLM) including cash related faults and Second Line maintenance (SLM) for all machines' repair, spares replacements and maintenance service (response and resolution), round the clock throughout the year including 2<sup>nd</sup> and 4<sup>th</sup> Saturdays, Sundays and Holidays during the terms of contract on oral / telephonic / email / SMS / Mobile Application or any other mode of communication by the Bank or through its own service personnel or any service provider or any monitoring system through its own expert service resource wherever the ATMs are installed irrespective of number of physical visits at the site / endpoint and without any additional cost to the Bank. The service shall be made available by Vendor as under:

Category	Resolution Time / TAT	Penalty
VIP ATMs	<del>2</del> 4 Hours: Irrespective of the population group / category	<del>Rs. 1200/-</del> ₹500/- per endpoint per hour.
Regular ATMs	i. <del>4</del> 6 Hours: At Metro, Urban and Semi-urban locations	<del>Rs. 1000/-</del> ₹200/- per endpoint per hour.

Category	Resolution Time / TAT	Penalty
	ii. <b>6 8 Hours:</b> At Rural locations	
The Bank has the discretion of classifying the endpoints as VIP or Regular subject to review.		

### 3.2. Housekeeping:

3.2.1. Refer the detailed scope under Appendix-E “Scope of Services” of this RFP.

3.2.2. Maintenance of endpoint site clean and in proper condition. Cleaning of the site atleast twice a day including floor / glass / walls etc. for regular endpoints and atleast thrice a day for VIP endpoints.

3.2.3. Penalty shall be levied if ATM/ site / allied equipment(s) is not maintained clean and in proper condition. The penalty shall be levied for each instance reported by Channel Manager / Bank official / e-Surveillance / any customer / social media / any complaint etc., as under:

Category	Penalty
VIP ATMs	<del>Rs.3,000/-</del> ₹750/- per site per instance
Regular ATMs	<del>Rs.2,000/-</del> ₹500/- per site per instance

3.2.4. The ATM / site / allied equipment(s) should be cleaned within 30 minutes whenever such instance has been reported to Vendor (including the Vendor’s Management Centre / Vendor’s local representative etc.)

3.2.5. An additional penalty of ~~Rs. 5,000/-~~ ₹1,000/- per site per month shall be levied if Vendor receives more than 2 recorded complaints from the Bank for that particular site in the particular month, pertaining to unsatisfactory maintenance, upkeep and general cleaning of the sites. It will be the responsibility of the vendor to submit a daily report to the concerned Circles and the Channel Managers of the respective endpoint.

### 3.3. consumables:

3.3.1. Refer the detailed scope under Appendix-E “Scope of Services” of this RFP.

3.3.2. Consumables are required to be replenished well before it gets over.

3.3.3. **Penalty @ ~~Rs.1000/-~~ ₹100/-** per incident shall be levied if consumables are not made available within four hour from the time information available in Online Monitoring Tools or complaint lodged by Bank official at the portal and/ or advised by Channel Manager or by the Bank official in this regard. The consumables required are to be replaced by the vendor at the respective machines.

### 3.4. CASH MANAGEMENT:

#### 3.4.1. Penalty for not maintaining target FoS:

3.4.1.1. “**Factor of Safety (FoS)**”, i.e., the ideal amount of Cash that should be present in the endpoint to prevent Cash out and idle cash situation.

3.4.1.2. FoS will be fixed at **2.0** i.e., for every Rs.100 Cash withdrawn, there should be upto Rs. 200 cash available in the ATM. For illustration, it can be calculated as follows:

$$\frac{\text{[Opening cash in the ATM + Amount of cash replenished]}}{\text{Net cash withdrawn by customer during the day.}} = 2$$

3.4.1.3. FoS will be calculated on Daily basis at every individual Endpoint level (except days prior to the Bank Holiday).

3.4.1.4. There shall be a relaxation on days prior to the holiday because cash may not be available from the Bank on Sundays / Holidays. The FoS will be **2.5** for such instances, i.e., 2.5 times the cash withdrawn to be present in the ATM.

3.4.1.5. **If FoS is more than 2 or 2.5 as mentioned above, then interest @ prevailing SBI Clean Overdraft rate will be levied on the excess cash found above the prescribed norm.**

3.4.1.6. The following formula shall be used by the Bank to arrive at the amount of excess cash:

Excess cash = ~~opening balance + cash replenished closing balance~~ - Ideal cash;

where Ideal cash = ~~Average Cash dispensed~~ \* Average Daily withdrawal of previous month x Target FoS

- 3.4.1.7. The Vendor shall not hold or retain in their vault more than 15% of the total cash taken from Bank on monthly basis. If the retention is more than 15%, a penalty @ prevailing SBI clean overdraft rate per annum shall be levied on the excess cash retained in the vault during the month.
- 3.4.1.8. However, there will be no FoS penalty for first three months for any newly installed Endpoints. This relaxation is provided to understand the dispensing pattern of the newly installed endpoint for the initial period of three months.
- 3.4.1.9. The Bank may have the discretion to revise the clauses related to FoS, which shall be binding on the successful bidders.
- 3.4.1.10. In each Endpoint, replenishment / Evacuation of cash shall ordinarily be done once a day. In case the number of cash replenishment / evacuation is less than 15 days in a month, penalty @ Rs. 1,500/- for each day default for non-compliance of cash replenishment shall be imposed. This penalty shall be in addition to Cash out and other penalties as prescribed elsewhere in this RFP. However, Bank reserves the right to increase the number of Cash replenishment / Cash Evacuation days in a month at its sole discretion, as and when required, without any additional cost to the Bank.
- 3.4.1.11. Delay in EOD activity of endpoints as define in this RFP may result in reconciliation arrears. Penalty of Rs.100/- per day per endpoint for delay in EOD shall be levied.
- 3.4.1.12. ~~Circles shall decide to provide 50% waiver in FOS penalty (i.e., interest on excess cash) with respect to Geographical areas like hilly terrain, which are difficult areas such as part of Arunachal Pradesh, Mizoram, Nagaland, Tripura, Manipur, Meghalaya, Assam, Jammu & Kashmir, Sikkim, Himachal Pradesh, Uttarakhand and for the ATMs situated at another Centre (other than the district headquarters) and ATMs located at more than 40 KMs away from the cash link Branches.~~

#### 3.4.2. Cash Out:

3.4.2.1. For Cash Out, penalty shall be charged as under: -

- a) ~~Penalty shall be Rs. 2,500/- per incidence per endpoint for first 3 hours.~~

- ~~b) In case the cash out extends beyond 3 hours and upto 10 hours, then penalty shall be Rs.2,500/- (for First three hours) + Rs. 2,500 for each hour or part thereof (excluding first three hours).~~
- ~~c) if cash out continues beyond 10 hours, penalty shall be b) above (for first 10 hours) + Rs 5,000/- for each block of 4 hours or part thereof (excluding first 10 hours).~~

~~Example: If a cash out incident is closed within 3 hours, the penalty shall be Rs. 2,500/- only. However, if it is closed in 30 hours, the penalty would be Rs. 45,000/- (Rs. 2500/- for first 03 hours + Rs.17500/- for next 07 hours (2500x7) + Rs. 25000/- (5000/- X 5 for next 20 hours)~~

- a) Cash-out at any ATM of more than five (05) hours in a month will attract a flat penalty of ₹ 5,000/- per ATM.
- b) Apart from above a), in case the cash out extends beyond five (05) hours and upto 10 hours in a month, then penalty shall be ₹ 5,000/- (for First five hours) + ₹1,500/- for each hour (excluding first five hours in a month).
- c) if cash out continues beyond 10 hours in a month, penalty shall be for first 10 hours (as above, b)) + @ ₹500/- for each hour (excluding first 10 hours).

Example: If Cash-out at any ATM of more than five (05) hours in a month, will attract a penalty of ₹ 5,000/- per ATM. However, if Cash-out at any ATM is 20 hours in a month, the penalty would be ₹17,500/- (Rs. 5000/- for first 05 hours + ₹7,500/- for next 05 hours (₹1,500 x 5) + ₹5000/- (₹500 X 10 for next 10 hours in a month).

- d) Bank shall levy penalty of Rs 2,500/- per incident, if reject bins not cleared within 4 hours.

### 3.4.3. Cash Reconciliation:

3.4.3.1. At the time of EOD (end of day) activity CRA will reconcile physical cash in the cassettes of endpoints and in the purge bin (reject bin) with the ADMIN balance (end cash shown denomination wise in ADMIN slip). Delay in EOD activity of endpoints results in reconciliation arrears. Therefore, for delay in reconciliation, vendor shall pay Rs.100/- per day per endpoint for the delayed period. ~~However, Bank may at its discretion consider exceptional cases where EOD is not feasible daily due to genuine reason.~~ Further any Loss occurred / penalty paid on account of delay in settling of dispute transactions on account of non-submission of EOD report will be recovered from Vendor.



3.4.3.2. The Vendor shall ensure that the entire cash handed over by the Bank is replenished in the ATMs by end of the day against which it had been provided. Reconciliation in this regard must be done on T+ 1 (where T is the replenishment day) basis in case of vaulting facility is extended to vendor and / or on T+0 in case no vaulting facility is extended to Vendor. In any case the cash must reconcile either by replenishment in ATMs or depositing in Branches on T+1 basis, failing which an interest @ clean overdraft rate prevalent at the material time will be recovered from the vendor ~~along with the penalty of Rs. 5,000/-~~ per instance.

3.4.3.3. In respect of recovery of losses, Penalties, Defrauded amount if any, shall be made good by vendor along with interest thereon at Banks' prevailing clean overdraft interest rate at material time and along with penalty at the rate of Rs.10,000 per Rs. 1,00,000/- (one lakh) or part thereof, by Vendor to BANK within 30 (thirty) days of occurrence of such fraud without waiting for admissibility or settlement of the insurance claim, if any. If the Vendor fails to make such payment with the said period of 30 days, then Bank reserves the right to recover the same by invoking the Bank guarantee submitted.

#### 3.4.4. Counterfeit Currency:

3.4.4.1. The Vendor / CIT shall ensure correctness and genuineness of the cash and shall take only ATM fit currency notes for replenishment to its possession. Counting facility for currency notes shall be provided by the Bank. Once the note packets are received and acknowledged, Vendor would be responsible for shortage and fake currency if any, noticed subsequently. **A penalty of Rs 10,000/- per instance will be levied on the vendor whenever any Counterfeit Currency is detected by any manner from the following:**

- a) Evacuated cash from the ATM.
- b) Unreplenished cash returned to the Bank by Vendor / CIT,
- c) Genuine ATM-fit notes given by the Bank to Vendor / CIT for cash replenishment in ATM, but counterfeit notes were mixed / exchanged with genuine ones and replenished in ATMs by Vendor / CIT.
- d) Vendor shall compensate any loss to the Bank and / or penalty imposed on the Bank due to counterfeit currency.
- e) Vendor shall be responsible to make good the amount equivalent to the value of the counterfeit note immediately.

#### **4. PENALTY FOR NON-COMPLIANCE: (Non-compliance to the Statutory guidelines / any clause of RFP / SLA penalty)**

- 4.1. On account of non-compliance to the Statutory guidelines (issued by GOI / RBI etc.) guidelines or any clause of the RFP / SLA within the timeframe communicated by the Bank will lead to penal provisions.
- 4.2. Non-compliance to RBI / MHA guidelines on Cash Management Services in terms of RBI letter no. RBI / 2017-18 / 152 DCM (Plg) No. 3563 / 10.25.07 / 2017-18 April 06, 2018, will lead to penalty of Rs. 2,000 per day per Endpoint till the date it is complied with, and the compliance certificate is shared with the Bank. Bank may verify the said compliance on sample basis.
- 4.3. Non-compliance to RBI guidelines on the implementation of Cassette Swap Method in terms of RBI's letter No. RBI / 2017-18 / DCM (Plg.) No. 3641 / 10.25.007 / 2017-18 dated April 12, 2018, on Cassette Swap in ATMs and further refinement in this regard, if any. In case of non-compliance of specifications of lockable cassettes as per RBI letter a penalty as stipulated by RBI from time to time. The minimum penalty for non-compliance on account of cassette swap will be Rs. 5,000/- per day per ATMs.
- 4.4. The Vendors will ensure that their CIT / CRA will provide the uninterrupted services and in case of disruption of services on account of any reason Bank will recover the suitable cost from vendor in next bill up to the extent of Rs.5,000/- per endpoint per day for the period service was affected.
- 4.5. Penalty @ Rs.5,000/- per Endpoint will be recovered from the Bidder if Clauses relating to RBI, MHA, IS Audit, Other compliances / guidelines and any clause mentioned in the scope of work of this RFP along with any appendix / corrigendum / addendum (of this RFP), is not adhered / not complied / failed during audit testing. The bidder should ensure to comply with the instructions within the timeframe allowed by the Bank. Failure to comply, penalty of Rs.2,000 per endpoint per day shall be levied beyond the timeframe allowed by the Bank.
- 4.6. Any penalty levied on the Bank by RBI, MHA, Central / State Govt., Local Administration, any statutory body etc. for any penal activity / non-compliance attributable to the bidder, shall be recovered from the bidder. The Bank's decision in the matter shall be final and binding on the bidder. The same shall be recovered from vendor over and above the applicable penalty cap. In case, this penalty is compensated through a different clause of this RFP, the Bank may not levy the penalty again for same penal activity / non-compliance.

#### **5. SITE IMPLEMENTATION SERVICES:**

- 5.1. If the SIS is not completed within 30 days at metro areas and within 40 days at Rural / semi-Urban / Urban areas from the date of Purchase order placed by respective Circles, and the reason for delay is not attributable to the Bank, the vendor will be liable to pay a penalty of Rs. 5,000/- per machine per day from 31st day for metro and urban / 41st day for other areas, which will be realized / recovered from the vendor through their invoices. In case of any delay due to Bank dependency, the vendor has to advise the same in writing along with the necessary proof mentioning the cause of delay.
- 5.2. Any delay in operationalization of endpoints on account of Vendor's dispute with Government Authority on any count, shall be reckoned as part of delay and penalty shall be as applicable. In this connection, in case the vendor is unable to commence the required Services in reasonable time, Bank reserves the right to review / cancel the order and redistribute the same in a suitable manner.
- 5.3. Bank may undertake a quality test check of Endpoint sites by its own or external auditors of its choice to ascertain adherence by the Vendor to the technical specifications (both civil and electrical). Penalty shall be levied in case any material / equipment used are not in conformity with specifications laid down unless exemption has been obtained from Bank. Vendor has to ensure free replacement within 1 week from the date of informing the vendor plus penalty of Rs. 5,000/- per instance will be deducted if the material / equipment used are not in conformity with specifications laid down.
- 5.4. Replacement or repair of Lights, electrical components and any civil work repairs, printing & implementation of creatives / posters advised by the Bank from time-to-time at new and existing sites will be done by the bidder throughout the Contract Period and extension thereof. There should not be fading or torn off posters / external signage / stickers / notice board / door and external glass see-through creatives etc. and their replacements to be done by the bidder immediately. Any repair / replacement / modification / implantation task under Site Maintenance Activities advised by the Bank should be completed by the bidder within 5 days of intimation. Penalty @ ₹ 500 per day from the 6<sup>th</sup> Day onwards per non-complied site will be levied.
- 5.5. For the site, the time for attending to and rectifying faults in sites shall be up to one working day for metro / urban centres & up to two working days in other places (except for UPS). For all other vital items, the response and resolution time shall be one working day. For all other items which do not impact the operations of the endpoints, it shall be 2 working days. Penalties @ Rs.200/- per day shall be levied for delays in rectifying the faults – provided the site fault does not result in downtime of the Endpoint. For site faults that result in Endpoint

downtime, the penalties applicable for Endpoint downtime shall be levied. No penalties shall be levied for delays on account of force majeure.

- 5.6. Site feasibility should be done, and the report submitted within 10 days of the request made by the Bank. Penalty @ Rs. 200 per day will be levied thereafter. (The Bank may waive it at its sole discretion if a large number of sites – much more than the monthly plan -- are given at one time).
- 5.7. On account of any negligence, commission or omission by the engineers of the Vendor in delivery of Product and Services if any penalty or loss or damage caused to bank, Vendor shall indemnify / pay / reimburse all such penalty / loss / damage suffered by Bank.

## 5.8. Penalty for EDSS:

- 5.8.1. Bidder shall attend and rectify the break down / repair / replacement of EDSS call(s) registered by Bank / Bank's representative within ~~2~~ 4 days. Any repair / replacement / rectification / implantation task under EDSS advised by the Bank should be completed by the bidder within ~~2~~ 4 days of intimation. Penalty @ ₹ 500 per day from the ~~3<sup>rd</sup>~~ 5<sup>th</sup> day onwards per non-complied call(s) will be levied.
- 5.8.2. Bidder to ensure that no content without specific permission of the Bank shall display. No unsolicited / unwarranted content shall be displayed at any circumstances on EDSS. In case of non-compliance, penalty of Rs. 50,000 for each instance, alongwith any other penalty(ies) imposed on the Bank by any statutory body(ies), will be imposed and recovered from the bidder.
- 5.8.3. ~~e-Surveillance Systems (eSS)~~ EDSS should be functional / operational 24x7x365. If any deficiency observed / found by Bank / Bank's representative, a penalty of ~~Rs 2,000/=~~ ₹1,000/- per instance per site shall be recovered from the Vendor.

## 6. TESTING & MACHINE TECHNICAL ISSUES:

- 6.1. Bank's MVS, EPS, OMS, other software testing will be a criterion for the successful bidders. The successful bidders must deliver ~~2~~ ATM machines which are proposed for installation with ~~2~~ UPSs + Fast Charging SMF / Lithium-ion Batteries with atleast 8 hours backup (having Integrated Power Management feature) for testing at the Bank's ATM test Lab located in CBD Belapur, Navi Mumbai ~~within 10 days (calendar days) from the issuance of LOI as per the timeline provided by the Bank.~~ The machines have to be tested successfully for OEM / Native software and Bank's MVS, EPS, OMS platform including completion of EMV L3 certification and other softwares from all the scheme (wherever necessary) within 90 days (calendar days) of delivery of machines. ~~A penalty of Rs 10,000/- per day will be imposed on the bidders if their machines are either undelivered or not tested~~ If any delay (on account of bidder(s)) occurs ~~beyond 15 calendar days either for delivery or successful testing of machines~~ for MVS, EPS, OMS including completion of EMV L3 certification, other software and OEM / Native software within the prescribed timelines, the Bank ~~however has the discretion to review the penalty~~ reserves the right to cancel the allotted quantities and allocate such quantities to other successful bidder(s).

6.2. Actual loss incurred by the Bank on account of errors / bugs / deficiencies in services attributable to the Vendor shall be recovered from the vendor. The Bank's decision with regard to bug / defect / faulty functioning of the machine will be final and binding on the bidder. In case the bug / defect / faulty functioning resolution requires development / R&D from OEM of the endpoint, the Vendor should ensure that the OEM does the required development within the stipulated time agreed by the Bank. A penalty of Rs.1,000 per day per non-complied machine shall be applicable for delay after the agreed stipulated timeframe.

6.3. If OEM XFS application failed to provide dispensation status to Bank's MVS application and has resulted in customer complaint for which no excess cash is found in the endpoint, then Vendor is liable to bear the transaction amount and compensation to be paid to the customer along with any other loss / penalty imposed on Bank.

## **7. BANK'S REPUTATIONAL AND BUSINESS LOSS:**

7.1. Notwithstanding anything contained in RFP / SLA, the bidder hereby agrees and undertake those following losses incurred by the Bank / accrued to the Bank, if any on account of reasons attributable to the bidder, may be recovered from invoices of the service provider: -

- a) Actual loss accrued to the Bank on account of errors / bugs / deficiencies in development / support activities attributable to the service provider.
- b) Any loss accrued to the bank on account of loss of Business during the period of outage of application developed / maintained.
- c) Reputational loss due to the reasons attributable to the bidder.

## **8. PENALTY FOR NON-SUBMISSION OF BANK GUARANTEE:**

8.1. Non-submission of Bank Guarantee related to Cash loss within 15 days from the issue of PO by Circles, a penalty of Rs.5,000/- per day per machine will be charged to the vendor from the 16<sup>th</sup> day onwards till the same is submitted. In the event of failure on the part of the vendor to pay for cash losses as per the terms and conditions, the Bank shall be entitled to invoke the guarantee.

**9. E-SURVEILLANCE:**

Sl. No	Parameter	Metric	Penalty
1.	<b>Equipment Uptime</b>	At least 99% uptime expected. i. System is non-functional for more than 30 minutes up to 4 Hours, ii. system remains non-functional beyond 4 hrs and up to 24 hours, iii. system remains non-functional beyond 24Hrs. up to 48Hrs, iv. system remains non-functional beyond 48 Hrs,	i. Rs 1,500/- ii. Rs 2,500/- iii. Rs 3,500/- iv. Rs 5,000/- for that site for each instance of failure beyond 48 hours.
2.	<b>Non installation of E-Surveillance</b>	From the date of Cash Live	A penalty of Rs. 1,000/- per week from the next day of cash live, till the date of making e-Surveillance live. The penalty amount for delayed installations will be due on 1st day of the week. This will be over and above the monthly cap of 35% on bills payment.
3.	<b>Incident Reporting</b>	For every identified incident, vendor should have evidence of incident (video recording, two-way audio communication logs, system logs), records for action taken and reporting to respective authorities as per agreed mechanism.	To be randomly verified by SBI / SBI appointed agency on monthly basis for SLA monitoring. For every non-compliance a penalty of Rs. 1,000 per instance shall be levied.

Sl. No	Parameter	Metric	Penalty
4.	<b>Report to Bank</b>	All reports mentioned under "Scope of Work" to be submitted to Bank.	The service provider-wise availability / performance / system down reports to be downloaded from the new dashboard. To be randomly verified by SBI / SBI appointed agency on monthly basis for SLA monitoring. For every non-compliance a penalty of Rs. 1,000/- per instance shall be levied.
5.	<b>Loss to SBI due to un-reported / UNDETECTED incident</b>	For every loss incurred by SBI, for the incidences which are not reported / detected by the service provider.	Actual financial Loss as per incident.
6.	<b>Non-Supply of Video Footage &amp; Non-retention of footage as per the request received from the Bank</b>	For not providing CCTV footage for any incident / ENDPOINT transaction-based footage. For not providing clear images and video (face not recognizable)	Rs. 10,000 OR Actual loss to the bank, whichever is higher.
7	<b>Unable to manage the crowding / detection of person with mask or helmet.</b>	For any detected incident where ATM is crowded beyond allowed no. of persons. Person entering with masked face or helmet	Actual loss to the bank
8	<b>Failure of any equipment / sensor should be replaced / repaired within 24 hours.</b>		Beyond 24 hours, penalty will be as under: Rs 5000/- for that site for each instance of failure up to 72 hours.



Sl. No	Parameter	Metric	Penalty
			Rs 10,000/- for that site for each instance of failure beyond 72 hours.
9	Not providing the sites clean reports.		As per the structure mentioned in Housekeeping. The penalty shall be levied for each instance reported by Channel Manager/ bank official/ E-Surveillance reports.
10	Loss occurring out of equipment installed by service provider OR due to negligence on part of e-surveillance service provider or any of its associates OR, due to non-functioning of the system OR due to deficiency in services		Actual loss to the Bank
11.	Non-installation of dismantled site	If bank/bidder shifts the ATM to new location or discontinues the site, the reinstallation at new location next day of making the machine cash live	A penalty of Rs. 1,000/- per week from the next day of cash live, till the date of making e-Surveillance live. The penalty amount for delayed installations will be due on 1st day of the week.
12.	Non-maintenance of TAT for providing CCTV footages	For not providing images / footages within 1 day of receipt of such requests from the Bank.	Rs. 500/- per day for such delays beyond 1 day.

Sl. No	Parameter	Metric	Penalty
13.	<b>Non-Submission of e-surveillance system down report</b>	The caption report should be submitted next day by 12 noon to the Bank	Non-submission will attract penalty as:  (a) Upto 24 hours – Rs. 500 (b) From 24to 48 hours – Rs. 1,000 (c) From 48 to 72 hours – Rs. 1,500 (d) More than 72 hours - Rs. 2,000
14.	<b>eSS should be functional / operational 24x7x365.</b>	e-Surveillance Systems (eSS) should be functional / operational 24x7x365.	<b>If any deficiency observed / found by Bank / Bank's representative, a penalty of ₹1,000/- per instance per site shall be recovered from the Vendor.</b>

#### 10. EJ Penalties:

EJ Disconnected / Disputed Cases / Incomplete EJ / unavailable EJ:

The following penalties shall be applicable for non-performance / delayed performance of EJ related activities due to non-working of EJ module. Bank shall levy a penalty of Rs.1000/- per instance per day in case of:

- EJ disabled and EJ disconnected cases not resolved within T+1 days.
- In case EJ data is not complete or unavailable at endpoint itself, penalty shall be charged for actual amount of claim received with penalty amount paid by Bank to the claimant (if any), for which Vendor is liable to make good the claim to the Bank, on account of non-submission of EJ. It is the responsibility of the bidder to provide the EJ or make EJ available. Apart from it, if any losses occurred to the bank due to incomplete or non-availability of eJ by Vendor, the same shall be paid by Vendor to the Bank and it shall be recovered by the Bank from the Vendor.
- It is desirable that necessary agreements are in place between the respective vendor stakeholders (between TOM vendor, Hardware OEM, Software

vendor, Network SP) for field operational issues and necessary SOP may be prepared by the TOM vendor in documenting the roles and responsibilities of the respective stakeholders to avoid any dispute amongst vendor stakeholders in providing services to the Bank.

- d) Bank shall not be a party in such disputes, and it will be the responsibility of the successful bidder / Service provider (i.e., TOM vendors) for resolution of any transaction / EJ dispute and accountable for penalty if any in any event of non-availability or incomplete EJ / required logs due to MVS / Network / Hardware or any other issue.

**Appendix-J**  
**DRAFT SERVICE LEVEL AGREEMENT**

**Note: This is Indicative SLA only. Final SLA shall be executed with the successful bidder after successful testing of the supplied machines. Final SLA (alongwith annexures, schedules etc.) will be based on the clauses of this RFP (along with addendum/corrigendum, if any), which shall be shared with successful bidders and shall be binding on them.**

**AGREEMENT FOR SERVICES OF \_\_\_\_\_ ATMs UNDER TOTAL  
OUTSOURCED MODEL (TOM) ON PER TRANSACTION BASIS RATE- PHASE XVII**

**BETWEEN**

**STATE BANK OF INDIA**, Anytime Channel, Corporate Centre, 3rd Floor,  
World Trade Centre Arcde, Cuffe Parade, Mumbai 400005.

**AND**

\_\_\_\_\_ 1

**Date of Commencement:** \_\_\_\_\_ 2

**Date of Expiry:** \_\_\_\_\_

\_\_\_\_\_

This agreement ("Agreement") is made at \_\_\_\_\_ (Place) on this \_\_\_\_\_ day of \_\_\_\_\_ 20\_\_\_\_\_.

BETWEEN

State Bank of India, constituted under the State Bank of India Act, 1955 having its Corporate Centre and Central Office at State Bank Bhavan, Madame Cama Road, Nariman Point, Mumbai-21 and its Global IT Centre at Sector-11, CBD Belapur, Navi Mumbai- 400614 through its State Bank of India, Anytime Channel, Corporate Centre, 3rd Floor, World Trade Centre Arcade, Cuffe Parade, Mumbai 400005 Department hereinafter referred to as "the Bank" which expression shall unless repugnant to the context or meaning thereof shall include its successors & assigns of the First Part:

AND

\_\_\_\_\_ <sup>3</sup> a private/public limited company/LLP/Firm *<strike off whichever is not applicable>* incorporated under the provisions of the Companies Act, 1956/ Limited Liability Partnership Act 2008/ Indian Partnership Act 1932 *<strike off whichever is not applicable>*, having its registered office at \_\_\_\_\_ hereinafter referred to as "**Service Provider/ Vendor**", which expression shall mean to include its successors in title and permitted assigns of the Second Part:

WHEREAS

- (i) "The Bank" is carrying on business in banking in India and overseas and desirous to avail services of \_\_\_\_\_ ATMs under Total Outsourced Model (TOM) on per successful transaction rate.
- (ii) Service Provider is in the business of providing \_\_\_\_\_ and has agreed to provide the services as may be required by the Bank mentioned in the Request of Proposal (RFP) No. **SBI/AC/2023-24/003 dated: 17/08/2023** issued by the Bank along with its clarifications/ corrigenda, referred hereinafter as a "RFP" and same shall be part of this Agreement.

NOW THEREFORE, in consideration of the mutual covenants, undertakings and conditions set forth below, and for other valid consideration the acceptability and sufficiency of which are hereby acknowledged, the Parties hereby agree to the following terms and conditions hereinafter contained: -

## 2. DEFINITIONS & INTERPRETATION:

### 2.1 DEFINITIONS:

\_\_\_\_\_

Certain terms used in this Agreement are defined hereunder. Other terms used in this Agreement are defined where they are used and have the meanings there indicated. Unless otherwise specifically defined, those terms, acronyms and phrases in this Agreement that are utilized in the information technology services industry or other pertinent business context shall be interpreted in accordance with their generally understood meaning in such industry or business context, unless the context otherwise requires/mentions, the following definitions shall apply:

- 2.1.1 **“Bank / SBI”** ‘means **State Bank of India**, a Statutory Corporation constituted under the State Bank of India Act, 1955 having its Corporate Centre at SBI Bhawan, Madame Cama Road, Nariman Point, Mumbai 400021 also various other offices (LHOs / Head Offices / Administrative Offices / Regional Business Offices / Global Link Services / Global IT Centre etc.) of State Bank of India, domestic and foreign branches / other offices, other exchange companies available at various locations and managed by the Bank.
- 2.1.2 **“The Contract”** means the agreement entered into between the Bank and the Successful bidder(s) / Vendor(s), as recorded in the Contract Form signed by the parties, including all attachments and appendices thereto and all documents incorporated by reference therein.
- 2.1.3 **“RFP”** means the request for proposal (this document) in its entirety, inclusive of any addenda / corrigenda that may be issued by the Bank.
- 2.1.4 **“Agreement / Service Level Agreement (SLA) means** an agreement is a promise or commitment given by one party to another party. It includes an offer that is made by Bank after reverse auction and accepted by the Vendor(s).
- 2.1.5 **“The Project”** means takeover, handover and commissioning of Endpoints and making them functional for Services, integration of hardware, software and services with support etc. and other work under the scope of this RFP for the contract period and the extensions thereof.
- 2.1.6 **“GeM”** GeM is National Public Procurement Portal an end-to-end online Marketplace for Central and State Government Ministries / Departments, Central and State Public Sector Undertakings, Autonomous institutions and Local bodies, for procurement of common use goods and services.
- 2.1.7 **“TOM”** – Total Outsourced Model i.e. Per Successful Transaction based END to END solutions of the scope of works under this RFP including Installation, testing,

commissioning, deployment and maintenance, services of all Machines Hardware's including all Physical and Digital Security, site identification, site creation / renovation, Site Implementation Services (SIS), as per the Bank's Ambiance Guidelines, strengthening physical security of all endpoints and their peripherals, concealment of all loose wires, power, network ports, creation of back rooms etc., placing the machine through a false wall such that only front portion is available and the back portion with wires is in backroom, improving and maintaining sufficient lighting of the ATM room, mandatorily providing RAMP facility, any other repair work required at the ATM sites, Maintenance of machines with allied peripherals (like ACs, UPS, Fast charging SMF / Lithium-ion Batteries, stabilizers etc.), AMC (Annual Maintenance Contract) of all components, First Line Maintenance (FLM), Second Line Maintenance (SLM) of the machines, equipment etc., Providing specified Network Connectivity, Cash Replenishment / evacuation Services through (CRAs / CIT Agencies) with lockable cassette swap method mandatory ab-initio for all machines, usage of OTC (One time Combination) in vault locks of machines ab-initio, e-Surveillance Systems at all sites as per the specifications mentioned in this RFP, Implementation of External Digital Signage Solution at sites (as per Bank's discretion) alongwith its maintenance, Maintenance Services of all sites as per the specifications, Caretaker Services at sites wherever required by the Bank / State / District / Local Administration / Gol / IBA / RBI / MHA / NPCI etc. All existing Compliances of Guidelines / Advisory / Orders/ Instructions / SOP issued by Bank, State / District / Local Administration / Gol / IBA / RBI / MHA / NPCI etc. to be followed by successful bidders ab-initio for each machine / site. Any **new** future guidelines /advisory by any statutory / **regulatory** authority shall be complied **without any cost to the Bank with mutually agreed terms & conditions and within the timeline advised by the authority.**

2.1.8 **“Vendor(s) / Supplier(s) / Contractor(s) / Service Provider(s) / EndPoint Provider(s)”** is the successful Bidder(s) found eligible as per eligibility criteria set out in this RFP, whose technical Bid has been accepted and who has emerged as one of the Successful Bidder(s) as per the selection criteria set out in this RFP and to whom notification of award has been given by Bank

2.1.9 **“Total Project Cost / Total Cost of Ownership: “The Contract Price/ Project Cost”** means the total price (exclusive of all taxes) payable to the Vendor on per successful transaction cost basis for the entire contract period of 7 years as per the calculation method described in the Indicative Commercial Bid Appendix-F for the full and proper performance of its contractual obligations.

2.1.10 **“Applicant / Bidder / Service Provider / System Integrator”** means an eligible entity / Partnership firm / Company / LLP. submitting a Proposal / the Bid in response to this RFP. The Bidder means an entity capable of providing the sought

services under this RFP in TOM and must be an Indian firm / company / organization registered under the Indian Companies Act, 2013/1956.

- 2.1.11 **“Proposal / Bid”** means the written reply or submission of response as per requirements mentioned in this RFP.
- 2.1.12 **“ATM(s) / ATM Machine / Cash Dispenser (CD) / Equipment / Product / Endpoint / Endpoints/ Terminal / Machine”** means – all the hardware, it's all components, peripheral apparatus, associated software/ firmware/ operating software, Software Agent(s). Bank has defined the name of Cash Dispenser (CD) as Automated Teller Machines (ATMs) which has the capability to dispense currency notes after due authentication and support other non-financial transactions (like Balance Enquiry, Mini Statement, PIN change etc.), non-cash financial transactions (like trust donation, college fees payments etc.) of the Bank.
- 2.1.13 **“Services”** means all hardware and software products, services, scope of work under Appendix-E and deliverables to be provided by a Vendor as described in the RFP and include services ancillary to the development of the solution, such as installation, commissioning, integration with existing systems, provision of technical assistance, training, certifications, auditing and all other obligations of Service Provider covered under this RFP.
- 2.1.14 **“Endpoint Provider”** means the Vendor who has supplied / is to supply the Endpoints to provide services under this RFP.
- 2.1.15 **“Solution Provider / MVS Vendor”** means the Vendor Selected by the Bank for implementation of Multi - Vendor Software Solution and Endpoint Protection Solution.
- 2.1.16 **“VIP Endpoints”** are those endpoints which have been installed at Prime / VIP like Airports, In-touch Branches, E-corners / e-lobby, Railway / Metro Stations, shopping malls, Market Areas, Tech Parks, Important/ main Bank Branches or any other location as identified by the Circles. Bank shall identify specific endpoints not exceeding ~~20%~~ 05% of the endpoints allocated to the respective successful bidder(s) under this RFP as 'VIP Endpoints'. The list of VIP Endpoints can be reviewed by the Bank from time to time.
- 2.1.17 **“Regular Endpoints”** are all the other endpoints not included in the VIP category.
- 2.1.18 **“OEM Native Application”** means an application provided by Endpoint Manufacturer to run the Endpoint (ATMs / CDs etc.) (excluding Operating



System (OS), Firmware, Middleware, Device drivers, CEN XFS, Terminal Diagnostic Tools/Utilities etc.), following NDC or DDC message emulation protocol.

- 2.1.19 **“Support Services”** means those services ancillaries to the Endpoint, maintenance, central helpdesk & management centre, its support, troubleshooting and other such obligations.
- 2.1.20 **“The Project Site”** means locations where services as desired in this RFP document are to be provided.
- 2.1.21 **“ATS”** means Annual Technical Support Services required especially at endpoint level to keep the endpoint up and running smoothly and without interruption.
- 2.1.22 **“Annual Maintenance Contract (AMC)”** - It would be the annual cost of maintenance / upkeep / updation of product or specified hardware and software.
- 2.1.23 **“Financial Transaction”** means any transaction logged in the switch resulting in cash withdrawal through the endpoint and no reversal generated for such transaction. In future, conversion of Digital Rupee (issued by RBI) into physical currency and its withdrawal will be considered as a Financial Transaction.
- 2.1.24 **“Non-Cash Financial Transaction”** means any transaction logged in switch which is a type of transfer transaction and does not involve physical cash withdrawal. Example: Trust Donation, Mobile Top-up, etc. Also, in future, conversion of any account balance amount into Digital Rupee (issued by RBI) and vice-versa, not involving physical cash, will be considered as a “non-cash financial Transaction”.
- 2.1.25 **“Non-Financial transaction”** means any transaction logged in the switch which does not result in cash withdrawal through the ATM. Example of non-financial transactions: balance enquiry / mini-statement / PIN-change / and other Value-added services transaction / insufficient funds transaction / wrong pin transaction by the switch and are considered as payable to the Vendor.
- 2.1.26 **“Successful Transactions”** means following (undernoted) successful transactions which are logged into the Switch with response code 000 or 001 without any reversals, are only eligible for the **payment of invoices**: -

2.1.26.1 Financial (@ discovered per successful Financial Transaction rate):

- (i) Cash Withdrawals with no reversal;
- (ii) Cash withdrawals through Conversion of Digital Rupee (issued by RBI) with no reversal.

2.1.26.2 Non-Financial (@ discovered per non-Financial Transaction rate):

- (i) Balance enquiries;
- (i) Mini Statements;
- (ii) PIN Changes;
- (iii) Value-added services transactions;
- (iv) Non-Cash Financial Transactions like Trust Donation etc.;
- (v) Insufficient Fund Transactions;
- (vi) Wrong PIN Transactions.

**Note: Transactions involving multiple legs shall be considered as one transaction for payment.**

All other types of transactions (except under para **2.1.26.1** and **2.1.26.2** above) either System generated (like auto reversal postings, Admin transactions, 'Not-on-us' transaction postings to the ATM BGL a/c, profile requests and Money-Drawer messages etc.) or otherwise will not be admissible for the payment of invoices. No payment shall be made for unsuccessful transactions.

2.1.27 **“Unsuccessful Transactions”** means transactions which are not covered in above 3.26 “Successful transactions” above.

2.1.28 **ATM Software** should fully support to resolve any issue / bug related software / hardware / components / services / parameters / configurations / OS / XFS layer / devices / drivers / terminal diagnostic tools / utilities / patches provided by Endpoint provider for smooth running of solutions.

2.1.29 **MVS: Multi-Vendor Software (MVS)** - A standardized secure software solution and platform to run, manage and improve the functionality of the ATM network while providing additional functions like online monitoring of the ATMs.

2.1.30 **“Business Day / working day”** means a day which is not a weekly off including 2<sup>nd</sup> & 4<sup>th</sup> Saturday, Sunday or Public Holiday declared under NI Act.

2.1.31 **“Public Holidays”** shall mean public holidays under NI Act, at the place where the Equipment is located, when banks are closed for business.

2.1.32 **“Occurrence”** means a single event or a series of related event resulting in a loss or losses.

- 2.1.33 **“Response Time”** means interval between the trigger or alert generated by Bank’s ATM Online Monitoring Tool / MVS vendor to the vendor / bidder and latter’s arrival time at the respective ATM.
- 2.1.34 **“Bank Preventable Calls”** means a service call to the vendor / bidder and / or their subcontractors, if any. Bank preventable calls include but are not limited to, calls for FLM to replenish supplies, calls to CRA/CIT Agencies etc.
- 2.1.35 **“L1 / L2 / L3 .....so on”** The bidder with the lowest Rate value discovered during the Online Reverse Auction Process is considered as L1; the next bidder with subsequently higher quoted value than L1 will be L2 and so on. All successful bidders shall have to match price of L1.
- 2.1.36 **“CRA / CIT Agencies / CIT”** means Cash Replenishment Agencies / Cash-in-Transit Agencies who have been engaged for the cash replenishment in machines & cash evacuation from the machines as specified in the Cash Appendix of this RFP.
- 2.1.37 **“Confidential Information”** shall have the meaning set forth in this RFP and / or in SLA.
- 
- 2.1.38 **“Deficiencies”** shall mean defects arising from non-conformity with the agreed specifications and / or failure or non-conformity in the Scope of the work / Services as mentioned in this RFP.
- 2.1.39 **“Documentation”** means documentation that legally binding on all parties to it discharges, varies or supplementals the legal obligations contained in the agreement / SLA/ RFP/letter and will describe in detail and in a completely self-contained manner how the User may access and use the installation of ATMs under Total Outsourced Model \_\_\_\_\_ (name of the Software/ Hardware/ Maintenance Services) *<Strike off whichever is inapplicable>*, such that any reader of the Documentation can access, use and maintain all of the functionalities of the ..... (Name of Software) ..... (Service), without the need for any further instructions. ‘Documentation’ includes, user manuals, installation manuals, operation manuals, design documents, process documents, technical manuals, functional specification, software requirement specification, on-line tutorials / CBTs, system configuration documents, system / database administrative documents, debugging / diagnostics documents, test procedures, Review Records/ Test Bug Reports/ Root Cause Analysis Report, list of all Product components, list of all dependent/external modules and list of all documents relating to traceability of the Product as and when applicable etc.

- 2.1.40 **“Intellectual Property Rights”** shall mean, on a worldwide basis, any and all: (a) rights associated with works of authorship, including copyrights & moral rights; (b) Trade Marks; (c) trade secret rights; (d) patents, designs, algorithms and other industrial property rights; (e) other intellectual and industrial property rights of every kind and nature, however designated, whether arising by operation of law, contract, license or otherwise; and (f) registrations, initial applications, renewals, extensions, continuations, divisions or reissues thereof now or hereafter in force (including any rights in any of the foregoing).
- 2.1.41 **“Root Cause Analysis Report”** shall mean a report addressing a problem or non-conformance, in order to get to the ‘root cause’ of the problem, which thereby assists in correcting or eliminating the cause, and prevent the problem from recurring.
- 2.1.42 **“Commencement of Services”** shall mean the date on which the newly commissioned machine under this RFP is made **“cash-live”** and available for customer cash transactions. **“Cash-live”** means that the cash has been replenished in the machine and ATM performs cash withdrawal transactions successfully.
- 2.1.43 **“ATM Loss”** means loss of Valuables from a single ATM in respect of which the services are provided. The amount of loss is the face value of the Currency or valuable lost, plus the reasonable cost of reconstructing the negotiable instruments or other items of value (including re-issuance and stop-payment fees), stolen, lost or destroyed as a direct result of the Occurrence. ATM Losses also includes any loss of Valuables occurring outside the immediate physical proximity of the ATM, including but not limited to losses occurring while such Currency notes or Valuables are in transit or are in storage at a vault or similar location.

The amount of an ATM Loss also includes the face value of stolen, lost or destroyed negotiable instruments or other items of value, or any loss of any nature to the extent such loss results from:

- ATM equipment malfunction;
- mistakes in ATM loading, including but not limited to, Currency dispensed due to mis-loaded denominations, mis-configured cassettes, or mis-loaded cassettes etc.;
- discrepancies between network reports and ATM bill counter totals (in the event of such discrepancies, bill counter totals shall be deemed conclusive);
- Bank’s mistakes in verification;
- burglary; or
- damage from breakage;

➤ vandalism etc

## 2.2 **INTERPRETATIONS:**

2.2.1 Reference to a person includes any individual, firm, body corporate, association (whether incorporated or not) and authority or agency (whether government, semi government or local.

2.2.2 The singular includes the plural and vice versa.

2.2.3 Reference to any gender includes each other gender.

2.2.4 The provisions of the contents table, headings, clause numbers, italics, bold print and underlining is for ease of reference only and shall not affect the interpretation of this Agreement.

2.2.5 The Schedules, Annexures and Appendices to this Agreement shall form part of this Agreement.

2.2.6 A reference to any documents or agreements (and, where applicable, any of their respective provisions) means those documents or agreements as amended, supplemented or replaced from time to time provided they are amended, supplemented or replaced in the manner envisaged in the relevant documents or agreements.

2.2.7 A reference to any statute, regulation, rule or other legislative provision includes any amendment to the statutory modification or re-enactment or, legislative provisions substituted for, and any statutory instrument issued under that statute, regulation, rule or other legislative provision.

2.2.8 Any agreement, notice, consent, approval, disclosure or communication under or pursuant to this Agreement is to be in writing.

~~2.2.9~~ The terms not defined in this agreement shall be given the same meaning as given to them in the RFP. If no such meaning is given technical words shall be understood in technical sense in accordance with the industrial practices.

## 2.3 **COMMENCEMENT, TERM & CHANGE IN TERM:**

2.3.1 This Agreement shall commence from its date of execution mentioned above / be deemed to have commenced from \_\_\_\_\_ (Effective Date).

2.3.2 This Agreement shall be in force for a period of **seven (07)** year(s) from Effective Date, unless terminated by the Bank by notice in writing in accordance with the termination clauses of this Agreement.

2.3.3 The Bank shall have the right at its discretion to renew this Agreement in writing, for a further term **upto another three (03) years in one or more tranches after 7 years and such extension (if any required by Bank) shall be binding on selected bidder(s).**

2.3.4 ~~The Machine Site, for all practical purposes, belongs to the Bank.~~ Service Provider will, ~~therefore,~~ not transfer / sell / surrender / vacate the Site or / and enter into any contract / order / agreement with any other Bank / entity for the Site without Bank's permission. The Bank will also have the first right of refusal for the Site on termination / expiry of SLA.

### 3. **SCOPE OF WORK:**

3.1 The Scope and nature of the work which Service Provider has to provide to the Bank (Services) is described in **Annexure-A of SLA.**

### 4. **FEES / COMPENSATION**

4.1 The Compensation / payment terms is mentioned in the **Annexure-C of SLA.**

4.2 The Payment Terms for the work which Service Provider has to provide to the Bank (Services) is in terms of clauses given below:

4.2.1 All expenses, stamp duty and other charges/ expenses in connection with execution of this Agreement shall be borne by Service Provider. GST or any other tax imposed by the Government in lieu of same shall be borne by the Bank on actual upon production of original receipt wherever required.

4.2.2 Service Provider shall provide a clear description quantifying the service element and goods element in the invoices generated by them.

4.2.3 All billings will be on monthly basis in arrears for each Circle and payment shall be made by the respective Circles. The Bank may opt for a Centralized Bill Payment approach from its Corporate Centre instead of Circles.

4.2.4 Service Provider shall be paid fees and charges in the manner detailed in here under, the same shall be subject to deduction of income tax thereon wherever required under the provisions of the Income Tax Act by the Bank. The remittance

of amounts so deducted and issuance of certificate for such deductions shall be made by the Bank as per the laws and regulations for the time being in force. Nothing in the Agreement shall relieve Service Provider from his responsibility to pay any tax that may be levied in India on income and profits made by Service Provider in respect of this Agreement.

4.2.5 Bank shall be not liable for any duties, Taxes and other taxes imposed by Government in lieu of same.

### **4.3 PAYMENTS TERMS AND CONDITIONS**

4.3.1 Service Provider shall be paid fees and charges in the manner detailed in here under, the same shall be subject to deduction of income tax thereon wherever required under the provisions of the Income Tax Act by the Bank. The remittance of amounts so deducted and issuance of certificate for such deductions shall be made by the Bank as per the laws and regulations for the time being in force. Nothing in the Agreement shall relieve Service Provider from his responsibility to pay any tax that may be levied in India on income and profits made by Service Provider in respect of this Agreement. Bank shall be not liable for any duties, Taxes and other taxes imposed by Government in lieu of same.

4.3.2 All billings will be on monthly basis in arrears for each Circle and payment shall be made by the respective Circles. The Bank may opt for a Centralized Bill Payment approach from its Corporate Centre instead of Circles.

4.3.3 The Bank will pay properly submitted valid invoices within reasonable period but not exceeding 30 (thirty) days after its receipt thereof. All payments shall be made in Indian Rupees.

4.3.4 The Bank may withhold payment of any product / services that it disputes in good faith and may set-off penalty amount or any other amount or adjustment of amount which Service Provider owes to the Bank against amount payable to Service provider under this Agreement. However, before levying penalty or recovery of any damages, the Bank shall provide a written notice to Service Provider indicating the reasons for such penalty or recovery of damages. Service Provider shall have the liberty to present its case in writing together with documentary evidence, if any, within 21 (twenty-one) days. Penalty or damages, if any, recoverable from Service Provider shall be recovered by the Bank through a credit note or revised invoices. In case Service Provider fails to issue credit note/ revised invoice, the Bank shall have right to withhold the payment or set-off penal amount from current invoices.

4.3.5 Once Purchase Order or Letter of Intent is issued by the Bank, the said price will

remain fixed for the entire Contract period & extension thereof and shall not be subjected to variation on any account, including exchange rate fluctuations, any upward revision in duties, charges, etc.

4.3.6 However, the Bank will provide an increase in per Successful Transaction Rates under Appendix-F of the RFP. The increase would be indexed to Consumer Price Index (CPI) for Industrial Workers (All India General Index; Base 2016 = 100). This increase in per successful transaction rate would be approved by the Corporate Centre of the Bank every year on 1<sup>st</sup> May as enumerated in **Clauses 4.3.9 and 4.3.10** below (subject to fulfilment of conditions laid down by Bank) on the Basis of latest available CPI (IW) index and advised to all the Circles / selected vendors.

4.3.7 There would be a 2.5% cap on the annual increase in per Successful Transaction Rates. The Increment in payment would be directly correlated to the increase in the Index over 12 months period. For e.g., If the index value on 01<sup>st</sup> May 2023 is 120 which increases to 123 in 01<sup>st</sup> May 2024 thereby representing a 2.5% increase. The per Successful Transaction Rates would increase proportionately. However, if the index value increases beyond 2.5%, the increase in payment would be capped at 2.5%. The maximum Per Successful Financial Transaction Rate for Offsite ATMs permitted during the tenure of contract shall be Rs. 2 less than the prevailing interchange fee. If the difference between the increased price and prevailing Interchange fee is less than Rs. 2, then the per successful transaction rate will freeze (without revision) for the residual period of the contract and extension thereof. It will be revised only when the interchange fee is revised by RBI, subject to increased price shall always remain Rs. 02 less than RBI interchange fee.

4.3.8 If there is a decrease in CPI, **the existing rate** (of previous year i.e., prior to 1<sup>st</sup> May of the current year) will apply.

4.3.9 The revised rates shall be applicable from 1<sup>st</sup> May subject to the **fulfilment of Rollout Completion Conditions** mentioned below: -

4.3.9.1 All allotted base quota of ATMs to the respective successful bidders are **cash live** and available for Customer cash Transactions, **and**

4.3.9.2 All SIS (Site implementation services) required for allotted base quota of ATMs to the respective successful bidders are complete, **and**

4.3.9.3 All necessary compliances of RBI/IBA/NPCI/GOI/MHA etc. applicable for the base quota, attributable to the bidders, are complied with, **and**

4.3.9.4 Bank's MVS, EPS any other software are installed and working on all allotted base quota ATMs to the respective successful bidders.



**4.3.10 Subject to fulfilment of the Rollout Completion Conditions mentioned above (4.3.9.1 to 4.3.9.4):**

4.3.10.1 A letter will be issued by the Implementation and rollout department of the Corporate Centre declaring rollout completion, when all the points mentioned above are complied with.

4.3.10.2 The first revised rates will be applicable only w.e.f. the upcoming 1<sup>st</sup> May, one year after the Bank declared the **rollout completion date** as above.

For examples:

Complete rollout date	One year from rollout date	Date of 1 <sup>st</sup> CPI rate Applicable
30 Sep 2023	30 Sep 2024	01 May 2025
31 Dec 2023	31 Dec 2024	01 May 2025
31 Mar 2024	31 Mar 2025	01 May 2025
30 Jun 2024	30 Jun 2025	01 May 2026

**4.3.11 Rate Revision for Buffer Quota:** For each installed buffer quota ATM, the prevailing rates for base quota ATM in that current year shall be applicable.

**4.4 BANK GUARANTEE AND PENALTY:**

**4.4.1** Performance Bank Guarantee (PBG) shall be of the amount ~~08 (eight)%~~ **05 (five)%** of the Total Cost of Ownership (TCO) based on the Final reverse auction price (which shall be calculated and advised by the Bank to Selected Bidder(s)) with validity period of 96 months or till the end of the contract (including the extension period, if any), whichever is later, furnished hereunder strictly on the format provided in the RFP is to be submitted by the finally selected Vendor.

**4.4.2** Bank, at its own discretion and option can extend contract period beyond 07 years for further upto 03 years, in one or more tranches. In such condition the existing Performance Bank Guarantee should be extended for the number of extended year(s) + 1 year as advised by the Bank.

**4.4.3** The PBG furnished hereunder should strictly be on the format at Appendix-H and is to be submitted within 30 days of receipt of formal communication by bank to finally selected bidders or within such extended period as may be decided by the Bank.

**4.4.4** For the buffer quota units, additional PBG on same terms and conditions on applicable TCO (for buffer quota) computed for the same calculation method should be submitted by the vendor(s).

**4.4.5** The PBG must be issued by a Scheduled Commercial Bank other than SBI and needs to be submitted within the specified time of receipt of formal communication from the Bank about their Bid finally selected. Purchase Order (PO) will be released only after receipt of the Performance Bank Guarantee. In case, SBI is the sole Banker for the Bidder, a Letter of Comfort from SBI may be accepted.

**4.4.6** The PBG is required to protect the interest of the Bank against delay in supply / installation and / or the risk of non-performance or failure to perform any obligation(s) under this RFP / SLA, either fully or partially, of the successful Bidder in respect of implementation of the project, or performance of the agreement(s) pursuant to this RFP / SLA or material or services sold, which may warrant invoking of PBG. In case any act of the supplier results in imposition of Liquidated Damages then also the Bank reserves the right to invoke the PBG.

**4.4.7** Performance of the obligations under the RFP / Agreement shall be made by Service Provider in accordance with the time schedule specified in this Agreement.

**4.4.8** The Successful bidder shall submit to the respective Circles / Local Head Office (LHO) a Bank Guarantee for the term of 96 months @ Rs. 50,000/- per endpoint in the specified format for securing the obligations in respect of cash loss in the number of endpoints allotted for cash services in each Circles. For any further addition of endpoints allotted to the Vendor during the currency of the agreement, additional Bank Guarantee on the same terms and conditions for added number of endpoints shall have to be provided by the Vendor to the Circles. Vendor should submit the Bank guarantee to the respective Circles Anytime Channels within 15 days from the issue of PO by Circle. Machines will be made cash live only after the receiving the Bank Guarantee. In case of non-submission of Bank Guarantee within timeline, a penalty of Rs.5000/- per day per machine will be charged to the vendor from the 16<sup>th</sup> day onwards till the same is submitted. In the event of failure on the part of the vendor to pay for cash losses as per the terms and conditions, the Bank shall be entitled to invoke the guarantee.

**4.4.9** If Service Provider fails to submit Performance Bank Guarantee / Bank Guarantee within the stipulated time schedule as specified in this Agreement , the Bank may without prejudice to its other remedies under the RFP / Agreement, and unless otherwise extension of time is agreed upon without the application of liquidated damages, deduct from the project cost, as liquidated damages a sum equivalent to 0.5% of Total Project Cost allocated to bidder for delay of each week or part thereof maximum up to 5% of Total Project Cost allocated to bidder. Once the maximum deduction is reached, the Bank may consider termination of the Agreement.

**4.4.10** If at any stage, Bank finds that a selected bidder has submitted any kind of false Certifications or Declarations, Bank has the right to reassign the orders to the other selected bidder and the bidder who has given false Certifications or Declarations will be

debarred / expelled from executing the orders further and Bank has the right to invoke its Performance Bank Guarantee, as well as initiate any other action as deemed fit by the Bank.

**4.4.11** If at any time during performance of the Contract, Service Provider should encounter conditions impeding timely delivery and performance of Services, Service Provider shall promptly notify the Bank in writing of the fact of the delay, its likely duration and cause(s). As soon as practicable after receipt of Service Provider's notice, the Bank shall evaluate the situation and may, at its discretion, extend Service Providers' time for performance, in which case, the extension shall be ratified by the parties by amendment of the Contract.

**4.4.12** Any delay in performing the obligation / defect in performance by Service Provider may result in imposition of penalty, liquidated damages, invocation of PBG / Bank Guarantee and / or termination of Contract (as laid down elsewhere in this RFP / SLA document)

**4.4.13** Service Provider shall be liable to pay penalty at the rate mentioned in **Annexure-D of SLA** in respect of any delay beyond the permitted period in providing the Services.

**4.4.14** No penalty shall be levied in case of delay(s) in deliverables or performance of the contract for the reasons solely and directly attributable to the Bank. On reaching the maximum of penalties specified the Bank reserves the right to terminate the contract.

**4.4.15** Any penalty mentioned anywhere in this RFP / SLA, but not specifically mentioned in Appendix-I (**Penalties & Incentives**), shall also applicable and binding to the Vendor.

## **5. LIABILITIES / OBLIGATION:**

### **5.1.1 The Bank's Duties /Responsibility (if any)**

- (i) Processing and authorising invoices.
- (ii)

### **5.1.2 Services Provider Duties**

- (i) To adhere to the service levels documented in this Agreement.
- (ii) Service Provider shall ensure to filter all phishing / spamming / overflow attacks in order to ensure availability and integrity on continuous basis.
- (iii) Service Provider shall *ensure that* Service Provider's personnel and its sub-contractors (if allowed) will abide by all reasonable directives issued by the Bank, including those set forth in the Bank's then-current standards, policies and procedures (to the extent applicable), all on-site rules of

behaviour, work schedules, security procedures and other standards, policies and procedures as established by the Bank from time to time.

- (iv) Service Provider agrees and declares that it shall be the sole responsibility of Service Provider to comply with the provisions of all the applicable laws, concerning or in relation to rendering of Services by Service Provider as envisaged under this Agreement.
- (v) Service Provider should ensure that the quality of methodologies for delivering the services, adhere to quality standards/timelines stipulated therefor.
- (vi) Service Provider shall provide and implement patches/ upgrades/ updates for hardware/ software/ operating System / middleware etc as and when released by them/ OEM or as per requirements of the Bank. Service Provider should bring to notice of the Bank all releases/ version changes.
- (vii) Service Provider shall obtain a written permission from the Bank before applying any of the patches/ upgrades/ updates. Vendor has to support older versions of the hardware/ software/ operating system /middleware etc in case the Bank chooses not to upgrade to latest version.
- (viii) Service Provider shall provide maintenance support for hardware/ software/ operating system/ middleware over the entire period of Contract.
- (ix) All product updates, upgrades & patches shall be provided by Service Provider free of cost during Contract period.
- (x) Service Provider shall support the product or specified hardware/software during the period of Contract as specified in Scope of work in the RFP.
- (xi) During the ATS / AMC period, Service Provider will have to undertake comprehensive support of the product or specified hardware / software and all new versions, releases, and updates for all standard product or specified hardware / software to be supplied to the Bank at no additional cost. During the support period, Service Provider shall maintain the product or specified hardware / software to comply with parameters defined in the RFP. Service Provider shall be responsible for all costs relating to labour, spares, maintenance (preventive and corrective), compliance of security requirements and transport charges from and to the Site (s) in connection with the repair/ replacement of product or specified hardware/software.
- (xii) During the support period, Service Provider shall ensure that services of

professionally qualified personnel are available for providing comprehensive on-site maintenance of the product or specified hardware/software and its components as per the Bank's requirements. Comprehensive maintenance shall include, among other things, day to day maintenance of the product or specified hardware/software a reloading of firmware/software, compliance to security requirements, etc. when required or in the event of system crash/malfunctioning, arranging and configuring facility as per the requirements of the Bank, fine tuning, system monitoring, log maintenance, etc. Service Provider shall provide services of an expert engineer at SBI GITC, Belapur or at other locations wherever required, whenever it is essential. In case of failure of product or specified hardware/software, Service Provider shall ensure that product or specified hardware/software is made operational to the full satisfaction of the Bank within the given timelines.

- (xiii) ATS/ AMC would be on-site and comprehensive in nature and must have back-to-back support from the OEM. Service Provider shall warrant products against defects arising out of faulty design etc. during the specified support period.
- (xiv) In the event of product or specified hardware/software break down or failures at any stage, protection available, which would include the following, shall be specified.
  - a) Diagnostics for identification of product or specified hardware/software failures
  - b) Protection of data/ configuration
  - c) Recovery/ restart facility
  - d) Backup of product or specified hardware/software / configuration
- (xv) Prompt support shall be made available as desired in the RFP during the support period at the locations as and when required by the Bank.
- (xvi) Service Provider shall be agreeable for on-call/on-site support during peak weeks (last and first week of each month) and at the time of switching over from PR to DR and vice-versa. No extra charge shall be paid by the Bank for such needs, if any, during the support period.
- (xvii) Service Provider support staff should be well trained to effectively handle queries raised by the customers/employees of the Bank.
- (xviii) Updated escalation matrix shall be made available to the Bank once in

each quarter and each time the matrix gets changed.

- (xix) Preliminary RCA of any event to be submitted to the Bank within 24 hours of occurrence of event and thereafter the final RCA to be submitted within a maximum of 72 hours.
- (xx) Service Provider shall provide documents related to review records/ Test Bug Reports/ Root Cause Analysis Report, list of all Product components, list of all dependent/external modules and list of all documents relating to traceability of service level failure as and when applicable.
- (xxi) Service Provider shall also provide the MIS reports as per requirements of the Bank. Any level/ version changes and/or clarification or corrections or modifications in the above-mentioned documentation should be supplied by Service Provider to the Bank, free of cost in timely manner.
- (xxii) Security Responsibility
  - a) To maintain the confidentiality of the Bank's resources and other intellectual property rights.
  - b) To comply with Bank's IS policy at all times during the tenor of agreement.

## **6. REPRESENTATIONS & WARRANTIES:**

**6.1 Each** of the Parties represents and warrants in relation to itself to the other that:

**6.1.1** It has all requisite corporate power and authority to execute, deliver and perform its obligations under this Agreement and has been fully authorized through applicable corporate process to do so.

**6.1.2** The person(s) signing this Agreement on behalf of the Parties have the necessary authority and approval for execution of this document and to bind his/their respective organization for due performance as set out in this Agreement. It has all necessary statutory and regulatory permissions, approvals and permits for the running and operation of its business.

**6.1.3** It has full right, title and interest in and to all software, copyrights, trade names, trademarks, service marks, logos symbols and other proprietary marks (collectively 'IPR') (including appropriate limited right of use of those owned by any of its vendors, affiliates or subcontractors) which it provides to the other Party, for use related to the Services to be provided under this Agreement.

**6.1.4** It will provide such cooperation as the other Party reasonably requests in order

to give full effect to the provisions of this Agreement.

**6.1.5** The execution and performance of this Agreement by either of the Parties does not and shall not violate any provision of any of the existing Agreement with any of the party and any other third party.

## **6.2 Additional Representation and Warranties by Service Provider**

**6.2.1** Service Provider shall perform the Services and carry out its obligations under the Agreement with due diligence, efficiency and economy, in accordance with generally accepted techniques and practices used in the industry and with professional standards recognized by international professional bodies and shall observe sound management practices. It shall employ appropriate advanced technology and safe and effective equipment, machinery, material and methods.

**6.2.2** Service Provider has the requisite technical and other competence, sufficient, suitable, qualified and experienced manpower/personnel and expertise in providing the Services to the Bank.

**6.2.3** Service Provider shall duly intimate to the Bank immediately, the changes, if any in the constitution of Service Provider.

**6.2.4** Service Provider warrants that to the best of its knowledge, as on the Effective Date of this Agreement, the services and products provided by Service Provider to the Bank do not violate or infringe any patent, copyright, trademarks, trade secrets or other intellectual property rights of any third party.

**6.2.5** Service provider shall ensure that all persons, employees, workers and other individuals engaged by or sub-contracted (if allowed) by Service Provider in rendering the Services under this Agreement have undergone proper background check, police verification and other necessary due diligence checks to examine their antecedence and ensure their suitability for such engagement. No person shall be engaged by Service provider unless such person is found to be suitable in such verification and Service Provider shall retain the records of such verification and shall produce the same to the Bank as and when requested.

**6.2.6** Service Provider warrants that at the time of delivery the software deployed/ upgraded as a part of this Agreement is free from malware, free from any obvious bugs, and free from any covert channels in the code (of the versions of the applications/software being delivered as well as any subsequent versions/modifications done). Software deployed/ upgraded as a part of this Agreement shall remain free from OWASP Top 10 vulnerabilities (latest) during the term of this Agreement.

**6.2.7** Service Provider represents and warrants that its personnel shall be present at

the Bank premises or any other place as the bank may direct, only for the Services and follow all the instructions provided by the Bank; act diligently, professionally and shall maintain the decorum and environment of the Bank; comply with all occupational, health or safety policies of the Bank.

**6.2.8** Service Provider warrants that it shall be solely liable and responsible for compliance of applicable Labour Laws in respect of its employee, agents, representatives and sub-contractors (if allowed) and in particular laws relating to terminal benefits such as pension, gratuity, provided fund, bonus or other benefits to which they may be entitled and the laws relating to contract labour, minimum wages, etc., and the Bank shall have no liability in this regard.

**6.2.9** During the Contract period, if any software or any component thereof is supplied by Service Provider is inoperable or suffers degraded performance, Service provider shall, at the Bank's request, promptly replace the software or specified component with new software of the same type and quality. Such replacement shall be accomplished without any adverse impact on the Bank's operations within agreed time frame and without any additional cost to the Bank.

## **7. GENERAL INDEMNITY:**

**7.1** Service Provider agrees and hereby keeps the Bank indemnified against all claims, actions, loss, damages,, costs, expenses, charges, including legal expenses (Attorney, Advocates fees included) which the Bank may suffer or incur on account of (i) Services Provider's breach of its warranties, covenants, responsibilities or obligations; or (ii) breach of confidentiality obligations mentioned in this Agreement; or (iii) any willful misconduct and gross negligent acts on the part of employees, agents, representatives or sub-contractors (if allowed) of Service Provider. Service Provider agrees to make good the loss suffered by the Bank.

**7.2** Service Provider hereby undertakes the responsibility to take all possible measures, at no additional cost, to avoid or rectify any issues which thereby results in non-performance of software/ hardware/ deliverables within reasonable time. The Bank shall report as far as possible all material defects to Service Provider without undue delay. Service Provider also undertakes to co-operate with other service providers thereby ensuring expected performance covered under scope of work.

**7.3** The Vendor hereby indemnifies the Bank, and shall always keep indemnified and hold the Bank, its employees, personnel, directors, (hereinafter collectively referred to as "Personnel") harmless from and against any and all losses, liabilities, claims, actions, costs and expenses (including attorneys' fees) awarded against the Bank relating to, resulting directly from or arising out of any claim, suit or proceeding brought against the Bank, as a result of:



- 7.3.1 Bank's bonafide use of the Deliverables and / or the Services provided by Vendor under this RFP; and/or
- 7.3.2 an act or omission of the Vendor, its employees, agents, sub-contractors in the performance of the obligations of the Vendor in breach of the RFP; and/or
- 7.3.3 claims made by employees or subcontractors or subcontractors' employees, who are deployed by the Vendor, against the Bank; and/or
- 7.3.4 any lease arrangement / rental arrangement/finance or loan arrangement in respect of or in relation to the Deliverables and Services provided under this RFP;
- 7.3.5 breach of any of the term of this Agreement or breach of any representation or false representation or inaccurate statement or assurance or covenant or warranty by the Vendor under this RFP; and/or
- 7.3.6 any or all Deliverables or Services infringing any patent, trademarks, copyrights or such other Intellectual Property Rights; and/or
- 7.3.7 breach of confidentiality obligations of the Vendor contained in this RFP; and/or
- 7.3.8 Gross negligence attributable to the Vendor or its employees or sub-contractors; and / or
- 7.3.9 any action taken, claims or fines imposed on Bank by any Government, statutory or regulatory authorities due to an act or omission on the part of the Vendor, which acts or omission in breach of this Agreement; and/or
- 7.3.10 any loss on account of any skimming, shimming or keypad-related fraud committed on the CDs attributable to the manufacturing defect in the CDs and specifically excluding frauds committed by using cards obtained/processed fraudulently outside the purview of reasonable control of the Vendor; and/or
- 7.3.11 any cash replenishment shortages committed by any employee of the Vendor and/or CMA engaged by Vendor; and/or
- 7.3.12 any losses, damages, costs incurred by the Bank on account of any third party claims due to any fault, imperfection on the equipment provided by the Vendor under this RFP; and/or

7.3.13 Fraud committed by the Vendors or its representatives resulting in Bank's image getting tarnished. The claim made by Bank in this regard shall be final and binding upon Vendor even though they have made good the monetary loss to the Bank.

7.4 The Vendor shall at its own cost and expenses defend or settle any claim against the Bank including that the Deliverables and Services delivered or provided under this RFP infringe a patent, utility model, industrial design, copyright, trade secret, mask work or trademark.

7.5 Vendor and/or its sub-contractors shall undertake thorough background check, due diligence in verifying the antecedents of its employees and shall indemnify and protect the Bank against all claims, losses, costs, damages, expenses, action suits and other proceedings resulting from any action of its employees or agents. In the event any such claim or legal action is initiated against the Bank by the employees/agents of Vendor or of the subcontractor's employees/agent or by any agent/employee of any agency engaged by the Vendor for providing any services including security arrangements, the Vendor shall immediately implead itself in such proceedings, contest or settle the matter at its costs. In any way the Vendor shall ensure that Bank is removed from the array of Defendants immediately. All costs and expenses including counsel fee shall be borne by the Vendor and the Bank shall be kept fully Indemnified in this regard by the Vendor.

7.6 During the contract period, Vendor and its outsourced agents shall comply with all statutory, regulatory provisions, relevant laws, guidelines, advisories etc, time to time framed by the Central Government / State Government / Local Bodies / RBI / MHA or any other statutory authority (s), including but not limited to Shops & Establishment Act, Minimum Wages Act, Contract Labour, Tax laws, all laws pertaining to contract employees required for providing the Services including Caretaker Services etc. and undertakes to keep the Bank indemnified against any such default (s) of his obligations under the compliance of such laws during the full contract period.

7.7 The Vendor's indemnity to the Bank under this Agreement is based on the Bank (i) providing prompt written notice to the Vendor of the event giving rise to indemnity claim; (ii) granting authority to the Vendor to defend or settle any action or claim covered by indemnity if the Vendor chooses to defend the case; (iii) providing at Vendor's expense, such information, cooperation and assistance to Vendor as may be reasonably necessary for the Vendor to defend or settle the claim or action; (iv) not taking any action that will prejudice Vendor's interests; and (v) taking all reasonable measures to mitigate the loss or damage caused due to the event giving rise to indemnity claim against the Vendor.

7.8 Neither Party shall be liable to the other for any special, indirect, incidental,

consequential (including loss of profit or revenue), exemplary or punitive damages, whether in contract, tort or other theories of law, even if such Party has been advised of the possibility of such damages.

7.9 Limitation of Liability: The total cumulative liability of either Party arising from or relating to this Agreement shall not exceed the total amount payable to the Vendor by the Bank for the contract period. Provided however, this limitation shall not apply to any liability or damages arising from (a) willful misconduct of the Vendor; (b) indemnification against third party claims for infringement; (c) breach of confidentiality obligations; (d) loss of Bank's Cash held in CD, in Transit and / or in Vault held by the Vendor or any agency engaged by the Vendor.

## 8. CONTINGENCY PLANS:

Service Provider shall arrange and ensure proper data recovery mechanism, attrition plan and other contingency plans to meet any unexpected obstruction to Service Provider or any employees or sub-contractors (if allowed) of Service Provider in rendering the Services or any part of the same under this Agreement to the Bank. Service Provider at Banks discretion shall co-operate with the Bank in case on any contingency.

## 9. TRANSITION REQUIREMENT:

In the event of failure of Service Provider to render the Services or in the event of termination of Agreement or expiry of term or otherwise, without prejudice to any other right, the Bank at its sole discretion may make alternate arrangement for getting the Services contracted with another vendor. In such case, the Bank shall give prior notice to the existing Service Provider. The existing Service Provider shall continue to provide services as per the terms of the Agreement until a 'New Service Provider' completely takes over the work. During the transition phase, the existing Service Provider shall render all reasonable assistances to the new Service Provider within such period prescribed by the Bank, at no extra cost to the Bank, for ensuring smooth switch over and continuity of Services, provided where transition services are required by the Bank or New Service Provider beyond the term of this Agreement, reasons for which are not attributable to Service Provider, payment shall be made to Service Provider for such additional period on the same rates and payment terms as specified in this Agreement. If existing vendor is found to be in breach of this obligation, they shall be liable for paying a penalty of Rs. \_\_\_\_\_ on demand to the Bank, which may be settled from the payment of invoices or bank guarantee for the contracted period. **Transition & Knowledge Transfer plan is mentioned in Annexure-G of SLA.**

## **10. LIQUIDATED DAMAGES:**

If Service Provider fails to deliver and perform any or all the Services within the stipulated time, schedule as specified in this RFP/Agreement, the Bank may, without prejudice to its other remedies under the RFP/Agreement, and unless otherwise extension of time is agreed upon without the application of liquidated damages, deduct from the Project Cost, as liquidated damages a sum equivalent to 0.5% of total Project Cost for delay of each week or part thereof maximum up to 5% of total Project Cost. Once the maximum deduction is reached, the Bank may consider termination of the Agreement.

## **11. RELATIONSHIP BETWEEN THE PARTIES:**

**11.1** It is specifically agreed that Service Provider shall act as independent service provider and shall not be deemed to be the Agent of the Bank except in respect of the transactions/services which give rise to Principal - Agent relationship by express agreement between the Parties.

**11.2** Neither Service Provider nor its employees, agents, representatives, Sub-Contractors shall hold out or represent as agents of the Bank.

**11.3** None of the employees, representatives or agents of Service Provider shall be entitled to claim any absorption or any other claim or benefit against the Bank.

**11.4** This Agreement shall not be construed as joint venture. Each Party shall be responsible for all its obligations towards its respective employees. No employee of any of the two Parties shall claim to be employee of other Party.

**11.5** All the obligations towards the employee(s) of a Party on account of personal accidents while working in the premises of the other Party shall remain with the respective employer and not on the Party in whose premises the accident occurred unless such accidents occurred due to gross negligent act of the Party in whose premises the accident occurred.

**11.6** For redressal of complaints of sexual harassment at workplace, Parties agree to comply with the policy framed by the Bank (including any amendment thereto) in pursuant to the Sexual Harassment of Women at Workplace (Prevention, Prohibition and Redressal) Act, 2013 including any amendment thereto.

## **12. SUB- CONTRACTING:**

Sub-contracting is permitted as per the procedure mentioned in scope of work.

12.1 As per scope of this agreement, sub-contracting of total scope of work is restricted. However, If the Bidder wishes to sub-contract any part of scope of work, it will have to obtain specific written permission from the Bank before subcontracting any work to subcontractors. Bank at its own discretion may permit, deny and review the same. The bank may at any time during the contract may cancel the permission given for the subcontracting vendor.

12.2 In case, subcontracting is permitted by the Bank, the Service provider will be responsible for all the sub-contracted services provided to the Bank regardless of which entity is conducting the operations. The Service provider is also responsible for ensuring that the sub-contractor complies with all security, statutory, Bank / RBI / MHA guidelines / local administration / Labour Laws etc., requirements of this RFP / SLA of Bank with the Service provider. The Bank can obtain independent audit report for the same. Service provider shall provide subcontracting details along with the copy of the executed Service Level Agreement (SLA) immediately (at least 15 days before commencement of that subcontracting service) to the Bank and if require, Bank may evaluate the same.

12.3 In Case of Sub-Contracting (if allowed by the Bank), the Service Provider shall provide the complete details of services sub-contracted by it including the details of sub-contractor(s) and /or its agent along with copy of agreement (SLA) with such sub-contractor to the Bank as and when requested.

12.4 In case of any requirement under scope of work, Bank or its officials shall have right to directly contact / follow-up / instruct to sub-contractor of the Vendor, and such sub-contractor (s) shall respond to bank and follow Bank's such instructions and shall take action accordingly. Vendor shall take care of such clause in subsequent agreement with Sub-contractor, if any and shall instruct the same to its sub-contractor.

### **13. ASSIGNMENT:**

13.1 Service Service Provider shall not transfer or assign at any stage, during the currency of this agreement, any of its duties, responsibilities, obligations and benefits of this agreement to any third party without the prior written consent of the Bank, except where Service Provider assigns this agreement to an Affiliate or a Joint Venture or to any entity which acquires the entire or partial stock or assets of Service Provider. However, prior notice has to be given to the Bank in all such cases.

### **14. INTELLECTUAL PROPERTY RIGHTS:**

14.1 For any technology / software / product used/supplied by Service Provider for performing Services for the Bank as part of this RFP, Service Provider shall have valid license to right to use as well as right to license such technology/ software / product. The Bank shall not be liable for any license or IPR violation on the part of Service

Provider.

14.2 Without the Bank's prior written approval, Service provider will not, in performing the Services, use or incorporate link to or call or depend in any way upon, any software or other intellectual property that is subject to an Open Source or Copy left license or any other agreement that may give rise to any third-party claims or to limit the Bank's rights under this RFP.

14.3 Subject to clause 14.4 and 14.5 of this RFP, Service Provider shall, at its own expenses without any limitation, indemnify and keep fully and effectively indemnified the Bank against all costs, claims, damages, demands, expenses and liabilities whatsoever nature arising out of or in connection with all claims of infringement of Intellectual Property Right, including patent, trademark, copyright, trade secret or industrial design rights of any third party arising from the Services or use of the technology / software / products or any part thereof in India or abroad.

14.4 The Bank will give Bank will give (a) notice to Service Provider of any such claim without delay/provide reasonable assistance to Service Provider in disposing of the claim; (b) sole authority to defend and settle such claim and; (c) will at no time admit to any liability for or express any intent to settle the claim provided that (i) Service Provider shall not partially settle any such claim without the written consent of the Bank, unless such settlement releases the Bank fully from such claim, (ii) Service Provider shall promptly provide the Bank with copies of all pleadings or similar documents relating to any such claim, (iii) Service Provider shall consult with the Bank with respect to the defense and settlement of any such claim, and (iv) in any litigation to which the Bank is also a party, the Bank shall be entitled to be separately represented at its own expenses by counsel of its own selection.

14.5 Service Provider shall have no obligations with respect to any infringement claims to the extent that the infringement claim arises or results from: (i) Service Provider's compliance with the Bank's specific technical designs or instructions (except where Service Provider knew or should have known that such compliance was likely to result in an Infringement Claim and Service Provider did not inform the Bank of the same); or (ii) any unauthorized modification or alteration of the deliverable (if any) by the Bank.

14.6 Service provider agrees that the Bank owns the entire right, title and interest to any inventions, designs, discoveries, writings and works of authorship, including all intellectual property rights, copyrights. Any work made under this RFP shall be deemed to be 'work made for hire' under any Indian/U.S. or any other applicable copyright laws.

14.7 The Intellectual Property Rights on the software code, copyright and source code for various applications/ interfaces developed under this RFP, and any other component/ framework/ middleware used/ developed as pre-built software assets to deliver the

solution, shall belong to the Bank and the Bank shall have complete and unrestricted rights on such property. However, Service Provider shall hold All Intellectual Property rights in any pre-built software *per se*, except for those which have been assigned under this Agreement.

14.8 All information processed by Service Provider during software maintenance belongs to the Bank. Service Provider shall not acquire any other right in respect of the information for the license to the rights owned by the Bank. Service Provider will implement mutually agreed controls to protect the information. Service Provider also agrees that it will protect the information appropriately.

## **15. INSPECTION AND AUDIT**

15.1 It is agreed by and between the parties that Service Provider shall be subject to annual audit by internal/external Auditors appointed by the Bank/ inspecting official from the Reserve Bank of India or any regulatory authority, covering the risk parameters finalized by the Bank/ such auditors in the areas of products (IT hardware/ software) and services etc. provided to the Bank and Service Provider shall submit such certification by such Auditors to the Bank. Service Provider and or his / their outsourced agents / sub – contractors (if allowed by the Bank) shall facilitate the same. The Bank can make its expert assessment on the efficiency and effectiveness of the security, control, risk management, governance system and process created by Service Provider. Service Provider shall, whenever required by such Auditors, furnish all relevant information, records/data to them. All costs for such audit shall be borne by the Bank. Except for the audit done by Reserve Bank of India or any statutory/regulatory authority, the Bank shall provide reasonable notice not less than 1 (ONE) day to Service Provider before such audit and same shall be conducted during normal business hours.

15.2 Where any Deficiency has been observed during audit of Service Provider on the risk parameters finalized by the Bank or in the certification submitted by the Auditors, it is agreed upon by Service Provider that it shall correct/ resolve the same at the earliest and shall provide all necessary documents related to resolution thereof and the auditor shall further certify in respect of resolution of the Deficiencies. It is also agreed that Service Provider shall provide certification of the auditor to the Bank regarding compliance of the observations made by the auditors covering the respective risk parameters against which such Deficiencies observed.

15.3 Service Provider further agrees that whenever required by the Bank, it will furnish all relevant information, records/data to such auditors and/or inspecting officials of the Bank/ Reserve Bank of India and/or any regulatory authority(ies). The Bank reserves the right to call for and/or retain any relevant information / audit reports on financial and security reviews with their findings undertaken by Service Provider. However, Service Provider shall not be obligated to provide records/ data not related to Services under the

Agreement (e.g., internal cost breakup etc.).

## **16. CONFIDENTIALITY:**

16.1 "Confidential Information" mean all information which is material to the business operations of either party or its affiliated companies, designated as being confidential or which, under the circumstances surrounding disclosure out to be treated as confidential, in any form including, but not limited to, proprietary information and trade secrets, whether or not protected under any patent, copy right or other intellectual property laws, in any oral, photographic or electronic form, whether contained on computer hard disks or floppy diskettes or otherwise without any limitation whatsoever. Without prejudice to the generality of the foregoing, the Confidential Information shall include all information about the party and its customers, costing and technical data, studies, consultants reports, financial information, computer models and programs, software Code, contracts, drawings, blue prints, specifications, operating techniques, processes, models, diagrams, data sheets, reports and other information with respect to any of the foregoing matters. All and every information received by the parties and marked confidential hereto shall be assumed to be confidential information unless otherwise proved. It is further agreed that the information relating to the Bank and its customers is deemed confidential whether marked confidential or not.

16.2 All information relating to the accounts of the Bank's customers shall be confidential information, whether labelled as such or otherwise.

16.3 All information relating to the infrastructure and Applications (including designs and processes) shall be deemed to be Confidential Information whether labelled as such or not. Service Provider personnel/resources responsible for the project are expected to take care that their representatives, where necessary, have executed a Non-Disclosure Agreement similar to comply with the confidential obligations under this Agreement.

16.4 Each party agrees that it will not disclose any Confidential Information received from the other to any third parties under any circumstances without the prior written consent of the other party unless such disclosure of Confidential Information is required by law, legal process or any order of any government authority. Service Provider in this connection, agrees to abide by the laws especially applicable to confidentiality of information relating to customers of Banks and the banks per-se, even when the disclosure is required under the law. In such event, the Party must notify the other Party that such disclosure has been made in accordance with law, legal process or order of a government authority.

16.5 Each party, including its personnel, shall use the Confidential Information



only for the purposes of achieving objectives set out in this Agreement. Use of the Confidential Information for any other purpose shall constitute breach of trust of the same.

16.6 Each party may disclose the Confidential Information to its personnel solely for the purpose of undertaking work directly related to the Agreement. The extent of Confidential Information disclosed shall be strictly limited to what is necessary for those particular personnel to perform his/her duties in connection with the Agreement. Further each Party shall ensure that each personnel representing the respective party agree to be bound by obligations of confidentiality no less restrictive than the terms of this Agreement.

16.7 COMPLIANCE WITH IS SECURITY POLICY:

**(This list is illustrative only and not exhaustive. Detailed guidelines shall be shared with successful bidders)**

The Vendor shall have to comply with Bank's IT & IS Security policy in key concern areas relevant to the contract. Some of the key areas are as under:

- (i) Responsibilities for data and application privacy and confidentiality
- (ii) Responsibilities on system and software access control and administration
- (iii) Custodial responsibilities for data, software, hardware and other assets of the Bank being managed by or assigned to the Vendor
- (iv) Physical Security of the facilities
- (v) Physical and logical separation from other customers of the Vendor
- (vi) Incident response and reporting procedures
- (vii) Password Policy of the Bank
- (viii) Data Encryption/Protection requirements of the Bank.
- (ix) In general, confidentiality, integrity and availability must be ensured.
- (x) All data are confidential and should not be disclosed to any external parties ever.
- (xi) Vendors need to comply with other existing and future policies/SOPs of the Bank related to logs/ ATM operations/Governance etc. In addition, Vendor is required to address the observations of various audits/examinations of Regulator as and when advised in the stipulated timeline.
- (xii) At the end of the project, after sharing all the Bank's data with the Bank, all the bank's data must be completely erased by using tools like disk eraser by the vendor. The vendor and its deployed resources should certify and confirm the Bank that all data associated with the project has been deleted from their laptops/PCs/email/cloud drives etc.
- (xiii) Whatever data the consultancy firm is having in their hard disk etc. related to the project, the same should be destroyed or returned to Bank. At the end of the project the consultancy firm to confirm that they are not having any data on account of this project. If the Bank requires the services of the Consultancy firm after project is

completed, the Bank shall share the required data with the firm. Office copies of the papers delivered to the Bank may be retained, subject to confidentiality obligation and should be destroyed within a reasonable period.

- (xiv) Vendor to follow control measures as mentioned in the RFP under the head “Controls to be implemented by third parties and to be monitored by IT applications owners”.

16.8 The non-disclosure obligations herein contained shall not be applicable only under the following circumstances:

- (i) Where Confidential Information comes into the public domain during or after the date of this Agreement otherwise than by disclosure by a receiving party in breach of the terms hereof.
- (ii) Where any Confidential Information was disclosed after receiving the written consent of the disclosing party.
- (iii) Where receiving party is requested or required by law or by any Court or governmental agency or authority to disclose any of the Confidential Information, then receiving party will provide the other Party with prompt notice of such request or requirement prior to such disclosure.
- (iv) Where any Confidential Information was received by the receiving party from a third party which does not have any obligations of confidentiality to the other Party.
- (v) Where Confidential Information is independently developed by receiving party without any reference to or use of disclosing party’s Confidential Information.

16.9 Receiving party undertakes to promptly notify disclosing party in writing any breach of obligation of the Agreement by its employees or representatives including confidentiality obligations. Receiving party acknowledges that monetary damages may not be the only and / or a sufficient remedy for unauthorized disclosure of Confidential Information and that disclosing party shall be entitled, without waiving any other rights or remedies, to injunctive or equitable relief as may be deemed proper by a Court of competent jurisdiction.

16.10 Service Provider shall not, without the Bank’s prior written consent, make use of any document or information received from the Bank except for purposes of performing the services and obligations under this Agreement.

16.11 Any document received from the Bank shall remain the property of the Bank and shall be returned (in all copies) to the Bank on completion of Service Provider’s performance under the Agreement.

16.12 Upon expiration or termination of the Agreement, all the Bank’s proprietary documents, customized programs partially or wholly completed and associated documentation, or the Bank’s materials which are directly related to

any project under the Agreement shall be delivered to the Bank or at the Bank's written instruction destroyed, and no copies shall be retained by Service provider without the Bank's written consent.

16.13 The foregoing obligations (collectively referred to as "Confidentiality Obligations") set out in this Agreement shall survive the term of this Agreement and for a period of five (5) years thereafter provided Confidentiality Obligations with respect to individually identifiable information, customer's data of Parties or software in human-readable form (e.g., source code) shall survive in perpetuity.

16.14 Bidder acknowledges and agrees that all tangible and intangible information obtained, developed or disclosed including all documents, contract, purchase order to be issued, data papers and statements and trade secret of the Bank relating to its business practices and their competitive position in the market place provided to the selected Bidder by the Bank in connection with the performance of obligations of Bidder under the purchase order to be issued, in part or complete shall be considered to be confidential and proprietary information ("Confidential Information") and shall not be disclosed to any third party/published without the written approval of the Bank.

**16.15** The Confidential Information will be safeguarded, and Bidder will take all the necessary action to protect it against misuse, loss, destruction, alterations, or deletions thereof. In the event of a breach or threatened breach by Bidder of this section, monetary damages may not be an adequate remedy; therefore, Bank shall be entitled to injunctive relief to restrain Bidder from any such breach, threatened or actual.

**16.16** Any document, other than the Contract itself, shall remain the property of the Bank and shall be returned (in all copies) to the Bank on completion of the Vendor's performance under the Contract, if so required by the Bank.

**16.17** Bidder acknowledges and agrees for data and application privacy and confidentiality during contract period as per Bank norms.

## **17. OWNERSHIP:**

17.1 Service Provider agrees that the Bank owns the entire right, title and interest to any inventions, designs, discoveries, writings and works of authorship, including all intellectual property rights, copyrights. Any work made under this Agreement shall be deemed to be 'work made for hire' under any Indian/U.S. or any other applicable copyright laws.

17.2 The Intellectual Property Rights on the software code, copyright and source code for various applications/ interfaces developed under this Agreement, and any other

component/ framework/ middleware used/ developed as pre-built software assets to deliver the solution, shall belong to the Bank and the Bank shall have complete and unrestricted rights on such property. However, Service Provider shall hold All Intellectual Property rights in any pre-built software *per se*, except for those which have been assigned under this Agreement.

17.3 All information processed by Service Provider during software maintenance belongs to the Bank. Service Provider shall not acquire any other right in respect of the information for the license to the rights owned by the Bank. Service Provider will implement mutually agreed controls to protect the information. Service Provider also agrees that it will protect the information appropriately.

## **18. TERMINATION:**

**18.1** The Bank may, without prejudice to any other remedy for breach of Agreement, by written notice of not less than 30 (thirty) days, terminate the Agreement in whole or in part:

**18.1.1** If Service Provider fails to deliver any or all the obligations within the time period specified in the Agreement, or any extension thereof granted by the Bank;

**18.1.2** If Service Provider fails to perform any other obligation(s) under the RFP / Agreement;

**18.1.3** Violations of any terms and conditions stipulated in the RFP;

**18.1.4** On happening of any termination event mentioned in the RFP / Agreement

Prior to providing a written notice of termination to Service Provider under clause 18.1.1 to 18.1.3, the Bank shall provide Service Provider with a written notice of 60 (sixty) days to cure such breach of the Agreement. If the breach continues or remains unrectified after expiry of cure period, the Bank shall have right to initiate action in accordance with above clause.

**18.2** The Bank, by written notice of not less than 60 (sixty) days may terminate the Contract, in whole or in part, for its convenience. In the event of termination of the Agreement for the Bank's convenience, Service Provider shall be entitled to receive payment for the Services rendered (delivered) up to the effective date of termination.

**18.3** In the event the Bank terminates the Agreement in whole or in part for the breaches attributable to Service Provider, the Bank may procure, upon such terms and in such manner, as it deems appropriate, Services similar to those undelivered

and subject to clause 20 Service Provider shall be liable to the Bank for any increase in costs for such similar Services. However, Service Provider, in case of part termination, shall continue the performance of the Agreement to the extent not terminated.

18.4 The Bank shall have a right to terminate the Agreement immediately by giving a notice in writing to Service Provider in the following eventualities:

18.4.1 If any Receiver / Liquidator is appointed in connection with the business of Service Provider or Service Provider transfers substantial assets in favour of its creditors or any orders / directions are issued by any Authority / Regulator which has the effect of suspension of the business of Service Provider.

18.4.2 If Service Provider applies to the Court or passes a resolution for voluntary winding up of or any other creditor / person files a petition for winding up or dissolution of Service Provider.

18.4.3 If any acts of commission or omission on the part of Service Provider or its agents, employees, sub-contractors or representatives, in the reasonable opinion of the Bank tantamount to fraud or prejudicial to the interest of the Bank or its employees.

18.4.4 Any document, information, data or statement submitted by Service Provider in response to RFP, based on which Service Provider was considered eligible or successful, is found to be false, incorrect or misleading.

18.5 In the event of the termination of the Agreement Service Provider shall be liable and responsible to return to the Bank all records, documents, data and information including Confidential Information pertains to or relating to the Bank in its possession.

18.6 In the event of termination of the Agreement for material breach, the Bank shall have the right to report such incident in accordance with the mandatory reporting obligations under the applicable law or regulations.

18.7 Upon termination or expiration of this Agreement, all rights and obligations of the Parties hereunder shall cease, except such rights and obligations as may have accrued on the date of termination or expiration; the obligation of indemnity; obligation of payment; confidentiality obligation; Governing Law clause; Dispute resolution clause; and any right which a Party may have under the applicable Law.

18.8 If the Contract is terminated under any termination clause, Service Provider shall handover all documents/ executable/ Bank's data or any other relevant

information to the Bank in timely manner and in proper format as per scope of the SLA and shall also support the orderly transition to another vendor or to the Bank.

18.9 The Bank's right to terminate the Contract will be in addition to the penalties / liquidated damages and other actions as specified in the SLA.

18.10 In the event of failure of Service Provider to render the Services or in the event of termination of Agreement or expiry of term or otherwise, without prejudice to any other right, the Bank at its sole discretion may make alternate arrangement for getting the Services contracted with another vendor. In such case, the Bank shall give prior notice to the existing Service Provider. The existing Service Provider shall continue to provide services as per the terms of the Agreement until a 'New Service Provider' completely takes over the work. During the transition phase, the existing Service Provider shall render all reasonable assistance to the new Service Provider within such period prescribed by the Bank, at no extra cost to the Bank, for ensuring smooth switch over and continuity of services, provided where transition services are required by the Bank or New Service Provider beyond the term of this Agreement, reasons for which are not attributable to Service Provider, payment shall be made to Service Provider for such additional period on the same rates and payment terms as specified in this Agreement. If existing Service Provider is breach of this obligation, they shall be liable for paying a penalty of 10% of the total Project Cost on demand to the Bank, which may be settled from the payment of invoices or Bank Guarantee for the contracted period or by invocation of Bank Guarantee.

## **19. DISPUTE REDRESSAL MACHANISM & GOVERNING LAW**

**19.1** All disputes or differences whatsoever arising between the parties out of or in connection with the Contract (including dispute concerning interpretation) or in discharge of any obligation arising out of the Contract (whether during the progress of work or after completion of such work and whether before or after the termination of the Contract, abandonment or breach of the Contract), shall be settled amicably.

**19.2** If the parties are not able to solve them amicably within 30 (thirty) days after dispute occurs as evidenced through the first written communication from any Party notifying the other regarding the disputes, either party (SBI or Service Provider), shall give written notice to other party clearly setting out there in specific dispute(s) and/or difference(s) and shall be referred to a sole arbitrator mutually agreed upon, and the award made in pursuance thereof shall be binding on the parties.

**19.3** In the absence of consensus about the single arbitrator, the dispute may be referred to an arbitration panel; one to be nominated by each party and the said arbitrators shall nominate a presiding arbitrator, before commencing the arbitration

proceedings. The arbitration shall be settled in accordance with the applicable Indian Laws and arbitration proceeding shall be conducted in accordance with Arbitration and Conciliation Act 1996 and any amendment thereto. Any appeal will be subject to the exclusive jurisdiction of courts at Mumbai.

19.4 Service Provider shall continue work under the Contract during the arbitration proceedings unless otherwise directed by the Bank or unless the matter is such that the work cannot possibly be continued until the decision of the arbitrator is obtained.

19.5 Arbitration proceeding shall be held at Mumbai, India, and the language of the arbitration proceedings and that of all documents and communications between the parties shall be in English.

19.6 All disputes or differences whatsoever arising between the parties out of or in connection with this Agreement (including dispute concerning interpretation) or in discharge of any obligation arising out of the Agreement (whether during the progress of work or after completion of such work and whether before or after the termination of this Agreement, abandonment or breach of this Agreement), shall be settled amicably.

19.7 If the parties are not able to solve them amicably within 30 (thirty) days after dispute occurs as evidenced through the first written communication from any party notifying the other regarding the disputes, either party (the Bank or Service Provider) shall give written notice to other party clearly setting out there in, specific dispute(s) and/or difference(s), and shall be referred to a sole arbitrator mutually agreed upon, and the award made in pursuance thereof shall be binding on the parties.

19.8 In the absence of consensus about the single arbitrator, the dispute may be referred to an arbitration panel; one to be nominated by each party and the said arbitrators shall nominate a presiding arbitrator, before commencing the arbitration proceedings. The arbitration shall be settled in accordance with the applicable Indian Laws and the arbitration shall be conducted in accordance with the Arbitration and Conciliation Act, 1996.

19.9 Service Provider shall continue work under the Agreement during the arbitration proceedings, unless otherwise directed by the Bank or unless the matter is such that the work cannot possibly be continued until the decision of the arbitrator is obtained.

19.10 Arbitration proceeding shall be held at **Mumbai**, India, and the language of the arbitration proceedings and that of all documents and communications between the parties shall be in English.

19.11 This Agreement shall be governed by laws in force in India. Subject to the arbitration clause above, all disputes arising out of or in relation to this Agreement, shall be subject to the exclusive jurisdiction of the courts at **Mumbai** only.

19.12 In case of any change in applicable laws that has an effect on the terms of this Agreement, the Parties agree that the Agreement may be reviewed, and if deemed necessary by the Parties, make necessary amendments to the Agreement by mutual agreement in good faith, in case of disagreement obligations mentioned in this clause shall be observed.

## **20. POWERS TO VARY OR OMIT WORK**

20.1 No alterations, amendments, omissions, additions, suspensions or variations of the services (hereinafter referred to as variation) under the contract shall be made by the successful Bidder except as directed in writing by Bank. The Bank shall have full powers, subject to the provision herein after contained, from time to time during the execution of the contract, by notice in writing to instruct the successful Bidder to make any variation without prejudice to the contract. The finally selected Bidder shall carry out such variation and be bound by the same conditions as far as applicable as though the said variations occurred in the contract documents. If any, suggested variations would, in the opinion of the finally selected Bidder, if carried out, prevent him from fulfilling any of his obligations under the contract, he shall notify Bank thereof in writing with reasons for holding such opinion and Bank shall instruct the successful Bidder to make such other modified variation without prejudice to the contract. The finally selected Bidder shall carry out such variation and be bound by the same conditions as far as applicable as though the said variations occurred in the contract documents. If the Bank confirms its instructions, the successful Bidder's obligations shall be modified to such an extent as may be mutually agreed, if such variation involves extra cost.

20.2 Any agreed difference in cost occasioned by such variation shall be mutually agreed between the parties. In any case in which Service provider has received instructions from the Bank as to the requirement of carrying out the altered or additional substituted work, which either then or later on, will in the opinion of Service provider, involve a claim for additional payments, such additional payments shall be mutually agreed in line with the terms and conditions of the order.

20.3 In any case in which the successful Bidder has received instructions from the Bank as to the requirements for carrying out the altered or additional substituted Services or work which either then or later on, will in the opinion of the finally selected Bidders, involve a claim for additional payments, such additional payments shall be mutually agreed in line with the terms and conditions of the order.

20.4 If any change in the services and / or work is likely to result in reduction in cost, the parties shall agree in writing so as to the extent of change in contract price, before the finally selected Bidder(s) proceeds with the change. In all the above cases, in the event of a disagreement as to the reasonableness of the said sum, the decision of the Bank shall prevail.

## **21. WAIVER OF RIGHTS**

Each Party agrees that any delay or omission on the part of the other Party to exercise any right, power or remedy under this RFP will not automatically operate as a waiver of such right, power or remedy or any other right, power or remedy and no waiver will be effective unless it is in writing and signed by the waiving Party. Further the waiver or the



single or partial exercise of any right, power or remedy by either Party hereunder on one occasion will not be construed as a bar to a waiver of any successive or other right, power or remedy on any other occasion.

## **22. LIMITATION OF LIABILITY**

22.1 The maximum aggregate liability of Service Provider, subject to clause 22.4, in respect of any claims, losses, costs or damages arising out of or in connection with this RFP/Agreement shall not exceed the total Project Cost.

22.2 Under no circumstances shall either Party be liable for any indirect, consequential or incidental losses, damages or claims including loss of profit, loss of business or revenue.

22.3 Service Provider will be liable for any losses incurred by the Bank which are attributable to Service Provider.

22.4 The limitations set forth herein shall not apply with respect to:

22.4.1 claims that are the subject of indemnification pursuant to infringement of third-party Intellectual Property Right;

22.4.2 damage(s) occasioned by the **Gross Negligence** or Wilful Misconduct of Service Provider,

22.4.3 damage(s) occasioned by Service Provider for breach of Confidentiality Obligations,

22.4.4 Regulatory or statutory fines imposed by a Government or Regulatory agency for non-compliance of statutory or regulatory guidelines applicable to the Bank due to inaction on the part of vendor, provided such guidelines were brought to the notice of service provider. The regulatory and statutory Penalty/fines will be recovered from the vendor for the reasons attributable to the vendor under the services provided by the vendor to the Bank under the project.

For the purpose of **clause 22.4.2 “Gross Negligence”** means any act or omission of act or failure to act by a party which was in reckless disregard of or gross indifference to the obligation of the party under this Agreement and which causes injury, damage to life, personal safety, real property, harmful consequences to the other party, which such party knew, or would have known if it was acting as a reasonable person, would result from such act or failure to act for which such Party is legally liable. Notwithstanding the forgoing, Gross Negligence shall not include

any action taken in good faith.

**“Wilful Misconduct” means** any act or failure to act with an intentional disregard of any provision of this Agreement, which a party knew or should have known if it was acting as a reasonable person, which would result in injury, damage to life, personal safety, real property, harmful consequences to the other party, but shall not include any error of judgment or mistake made in good faith.

## **23. FORCE MAJEURE**

**23.1** Notwithstanding the provisions of terms and conditions contained in this RFP / Agreement, and agreement neither party shall be liable for any delay in performing its obligations herein if and to the extent that such delay is the result of an event of Force Majeure.

**23.2** For the purposes of this clause, 'Force Majeure' means and includes wars, insurrections, revolution, civil disturbance, riots, terrorist acts, public strikes, hartal, bundh, fires, floods, epidemic, quarantine restrictions, freight embargoes, declared general strikes in relevant industries, Vis Major, acts of Government in their sovereign capacity, Curfew or Lockdowns by notification of the State / District Govts impeding reasonable performance of Service Provider and / or Sub-Contractor but does not include any foreseeable events, commercial considerations or those involving fault or negligence on the part of the party claiming Force Majeure.

**23.3** If a Force Majeure situation arises, Service Provider shall promptly notify the Bank in writing of such condition and the cause thereof. Unless otherwise directed by the Bank in writing, Service Provider shall continue to perform its obligations under the Contract as far as is reasonably practical and shall seek all reasonable alternative means for performance not prevented by the Force Majeure event.

## **24. NOTICES and OTHER TERMS & CONDITIONS:**

Any notice or any other communication required to be given under this Agreement shall be in writing and may be given by delivering the same by hand or sending the same by prepaid registered mail, postage prepaid, or facsimile to the relevant address set forth below or such other address as each Party may notify in writing to the other Party from time to time. Any such notice given as aforesaid shall be deemed to be served or received at the time upon delivery (if delivered by hand) or upon actual receipt (if given by postage prepaid, telegram or facsimile).

24.1 The notice shall be effective when delivered or on the notice's effective date whichever is later.

## **25. VENDOR'S OBLIGATION:**

25.1 The proposal includes machine/ equipment or software marketed and/or supported by other companies or individuals, the selected bidder, as the prime contractor for the delivery, testing, installation and maintenance of the entire system, must ensure and declare that they possess the requisite permission/ license for the machine/ equipment/ software. Also, the selected bidder commits to support/ repair/ replace/ maintain all parts of the Endpoint, irrespective of the position whether the parts are manufactured by the Bidder or outsourced by them.

25.2 The Bidder is responsible for and obliged to conduct all contracted activities in accordance with the contract using state-of-the-art methods and economic principles and exercising all means available to achieve the performance specified in Contract.

25.3 The bidder will be responsible for arranging and procuring all relevant permissions / Road Permits etc. for transportation of the machine to the location where installation is to be done. The Bank would only provide necessary letters for enabling procurement of the same.

25.4 The Bidder is obliged to work closely with the Bank's staff, act within its own authority and abide by directives issued by the Bank and implementation activities.

25.5 The Bidder will abide by the job safety measures prevalent in India and will free the Bank from all demands or responsibilities arising from accidents or loss of life, the cause of which is the Bidder's negligence.

25.6 The Bidder is responsible for managing the activities of its personnel or sub-contracted personnel and will hold itself responsible for any misdemeanours.

25.7 The Selected bidder(s) shall be responsible for compliance with all laws, rules, regulations, orders, notifications, and directions applicable in respect of its personnel (including, but not limited to, the Contract Labour (Prohibition and Regulation) Act 1986, the Payment of Bonuses Act 1965, the Minimum Wages Act 1948, the Employees' Provident Fund Act 1952, and the Workmen's Compensation Act 1923,) and shall maintain all proper records, including, but not limited to, accounting records required under the Applicable Laws, or any code, practice or corporate policy applicable to it from time to time.

## **26. GENERAL TERMS & CONDITIONS**

26.1 **TRAINING:** Service Provider shall train designated Bank officials on the configuration, operation/ functionalities, maintenance, support & administration for

software, application architecture and components, installation, troubleshooting processes of the proposed Services as mentioned in this RFP / Agreement.

26.2 **PUBLICITY:** Service Provider may make a reference of the services rendered to the Bank covered under this Agreement on Service provider's Web Site or in their sales presentations, promotional materials, business plans or news releases etc., only after prior written approval from the Bank.

26.3 **SUCCESSORS AND ASSIGNS:** This Agreement shall bind and inure to the benefit of the parties, and their respective successors and permitted assigns.

26.4 **NON-HIRE AND NON-SOLICITATION:** During the term of this Agreement and for a period of one year thereafter, neither party shall (either directly or indirectly through a third party) employ, solicit to employ, cause to be solicited for the purpose of employment or offer employment to any employee(s) of the other party, or aid any third person to do so, without the specific written consent of the other party. However, nothing in this clause shall affect the Bank's regular recruitments as per its recruitment policy and not targeted to the employees of Service provider.

26.5 **SEVERABILITY:** The invalidity or unenforceability of any provision of this Agreement shall not in any way effect, impair or render unenforceable this Agreement or any other provision contained herein, which shall remain in full force and effect.

26.6 **MODIFICATION:** This Agreement may not be modified or amended except in writing signed by duly authorized representatives of each party with express mention thereto of this Agreement.

26.7 **ENTIRE AGREEMENT:** The following documents along with all addenda issued thereto shall be deemed to form and be read and construed as integral part of this Agreement.

**Annexure – A: Scope of Work for ATM Outsourcing Services**

**Annexure – B: Technical & Functional Specifications (TFS)**

**Annexure – C: Payment Services**

**Annexure – D: Penalty**

**Annexure – E: Implementation Plan for TOM ATMs**

**Annexure – F: Non-Disclosure Agreement**

**Annexure – G: Transition & Knowledge Transfer plan.**

In case of any contradiction between or among them the priority in which a document would prevail over another would be as laid down below beginning from the highest priority to the lowest priority:

- 26.7.1 This Agreement;
- 26.7.2 Annexure of Agreement;
- 26.7.3 Purchase Order No. \_\_\_\_\_ dated \_\_\_\_\_; and
- 26.7.4 RFP with and amendments/corrigendum hereto

26.8 **PRIVITY:** Neither this Agreement nor any provision hereof is intended to confer upon any person/s other than the Parties to this Agreement any rights or remedies hereunder.

26.9 **DUE AUTHORISATION:** Each of the undersigned hereby represents to the other that she / he is authorized to enter into this Agreement and bind the respective parties to this Agreement.

26.10 **COUNTERPART:** This Agreement is executed in duplicate and each copy is treated as original for all legal purposes.

**27. PROJECT PLAN, DELIVERY AND SCHEDULE:**

**27.1. Testing of machine and piloting of tested Machines:**

**X- The date of Letter of Intent (LOI).**

Activity	Sub-Activity	No. of Calendar Days
Test Machine delivery	iv. Delivery of test machines (one endpoint of one model of each OEM with atleast 2 Harddisks for each endpoint) v. UPS & atleast 8 hours back up fast charging SMF / Lithium-ion batteries for each machine vi. All software(s) / drivers / OEM Native Applications / licenses etc. at IT-ATM Lab and thereafter in Live environment. All Deliverables for testing mentioned in the RFP in Appendix-E.	Y = X + 10 calendar days
Testing of machines	Customization, Integration, testing etc. (including end to end UAT / SIT / Security Review etc.) by the successful bidders or their representatives (OEM of machine), with OEM Native Applications / Agents at test environment at IT-ATM Lab and thereafter in Live environment. Scope of testing is mentioned in this RFP in Appendix-E..	Y + 90 calendar days

Activity	Sub-Activity	No. of Calendar Days
Pilot	Live Pilot Testing, Monitoring and Observations	Y + 105 calendar days

**27.2. Overall Rollout Plan details:**

a) **Z = Overall Purchase Order (PO) date from Anytime Channels, Corporate Centre, after successful Live Pilot completion.**

<b>Tranche</b>	<b>Tentative Rollout Number of units</b>	<b>Timelines in Days for Cash-live</b>
I: Replacement of existing old BLA (MoF) and old TOM ATMs.	13,500	Z + 90

b) **Note:**

- i. **Site wise Bulk Purchase Order for replacement of old machines shall be issued by Anytime Channel Corporate Centre, Mumbai and penalty for delayed cash-live of services will be calculated from this Purchase Order date.**
- ii. **For buffer quota ATMs or new ATM installations, the purchase order shall be issued by the respective Circles and penalty for delayed cash-live of services will be calculated from the Purchase Order date.**
- iii. **The rollout schedule must be adhered to by the successful bidders, irrespective of the total number of successful bidders.**
- iv. **In case the entire procurement of the said services is allotted to L1 / single vendor then the vendor should be in position to roll out the total quantities as per the timelines mentioned above.**
- v. **Allocation of Circles among successful bidders will be done by the Bank at its sole discretion and will be binding on the successful bidders.**
- vi. **The Overall Rollout number of units within each tranche are tentative. The Bank reserves the right to change the number of units specified within Tranches without any overall change in the Total Allocated units to a successful bidder.**

**27.3. Tranche-wise Rollout Plan details:**

**I. Replacement of existing old BLA (MoF) and old TOM ATMs**

<b>Tentative Rollout Number of units</b>	<b>Timelines in Days for Cash-live</b>
3000	Z + 30
4500	Z + 60
6000	Z + 90
<b>Total: 13,500</b>	<b>In Z + 90</b>

**II. Tentative Allocation among Circles is as follows (This list is illustrative only and actual numbers of machines can be varied as per Bank's requirement):**

<b>Sr. No.</b>	<b>CIRCLE</b>	<b>TOTAL UNITS</b>
1	AHMEDABAD	690
2	AMARAVATI	70
3	BENGALURU	660
4	BHOPAL	2,550
5	BHUBANESHWAR	540
6	CHANDIGARH	1,500
7	CHENNAI	410
8	GUWAHATI	1,540
9	HYDERABAD	140
10	JAIPUR	1,140
11	KOLKATA	70
12	LUCKNOW	40
13	MAHARASHTRA	1,130
14	MUMBAI METRO	100
15	NEW DELHI	1,110
16	PATNA	1,250
17	THIRUVANANTHAPURAM	560
	<b>GRAND TOTAL</b>	<b>13,500</b>

IN WITNESS WHEREOF, the parties hereto have caused this Agreement to be executed by their duly authorized representatives as of the date and day first mentioned above.



State Bank of India

By:  
Name:  
Designation:  
Date:

\_\_\_\_\_ Service Provider

By:  
Name:  
Designation:  
Date:

WITNESS:

- |    |    |
|----|----|
| 1. | 1. |
| 2. | 2. |

**Annexure – A: Scope of Work for ATM Outsourcing Services**  
As per Appendix-E of the RFP (given separately in the agreement).

**Annexure – B: Technical & Functional Specifications (TFS)**  
As per Appendix-C (with its sub-parts) of the RFP (given separately in the agreement).

**Annexure – C: Payment Services**  
As per the discovered Successful Financial Transaction rate and other terms & conditions of the RFP.

**Annexure – D: Penalty**  
As per Appendix-I of the RFP (given separately in the agreement).

**Annexure – E: Implementation Plan for TOM ATMs**  
To be shared to successful bidder as per the RFP

**Annexure – F: Non-Disclosure Agreement**

**Appendix-P 351 Certificate for Tenders for Works under Rule 144 (xi) General Financial Rules (GFRs), 2017**

**Appendix-Q 373 RAMP SPECIFICATIONS**

**Escalation metrix**

XXXXXXXXXXXXXXXXXXXX **END OF INDICATIVE SLA** XXXXXXXXXXXXXXXXXXXXXXX

**Appendix-K**  
**NON-DISCLOSURE AGREEMENT**

THIS RECIPROCAL NON-DISCLOSURE AGREEMENT (the "Agreement") is made at \_\_\_\_\_ between:

State Bank of India constituted under the State Bank of India Act, 1955 having its Corporate Centre and Central Office at State Bank Bhavan, Madame Cama Road, Nariman Point, Mumbai-21 and one of its offices at **Anytime Channels Department at, 3<sup>rd</sup> floor, World Trade Centre, Cuffe Parade, Mumbai 400005 (procuring office address)**, (hereinafter referred to as "Bank" which expression includes its successors and assigns) of the ONE PART;

And

\_\_\_\_\_ a private / public limited company / LLP / Partnership Firm *<strike off whichever is not applicable>* incorporated under the provisions of the Companies Act, 1956/ Limited Liability Partnership Act 2008 / Indian Partnership Act 1932 *<strike off whichever is not applicable>*, having its registered office at \_\_\_\_\_ (hereinafter referred to as "\_\_\_\_\_") which expression shall unless repugnant to the subject or context thereof, shall mean and include its successors and permitted assigns) of the OTHER PART;

And Whereas

1. \_\_\_\_\_ is carrying on business of providing \_\_\_\_\_, has agreed to \_\_\_\_\_ for the Bank and other related tasks.

2. For purposes of advancing their business relationship, the parties would need to disclose certain valuable confidential information to each other (the Party receiving the information being referred to as the "Receiving Party" and the Party disclosing the information being referred to as the "Disclosing Party. Therefore, in consideration of covenants and agreements contained herein for the mutual disclosure of confidential information to each other, and intending to be legally bound, the parties agree to terms and conditions as set out hereunder.

**NOW IT IS HEREBY AGREED BY AND BETWEEN THE PARTIES AS UNDER**

**1. Confidential Information and Confidential Materials:**

(a) "Confidential Information" means non-public information that Disclosing Party designates as being confidential or which, under the circumstances surrounding disclosure ought to be treated as confidential. "Confidential Information" includes, without limitation, information relating to developed, installed or purchased Disclosing Party software or hardware products, the information relating to general architecture of

Disclosing Party's network, information relating to nature and content of data stored within network or in any other storage media, Disclosing Party's business policies, practices, methodology, policy design delivery, and information received from others that Disclosing Party is obligated to treat as confidential. Confidential Information disclosed to Receiving Party by any Disclosing Party Subsidiary and/ or agents is covered by this agreement

(b) Confidential Information shall not include any information that: (i) is or subsequently becomes publicly available without Receiving Party's breach of any obligation owed to Disclosing party; (ii) becomes known to Receiving Party free from any confidentiality obligations prior to Disclosing Party's disclosure of such information to Receiving Party; (iii) became known to Receiving Party from a source other than Disclosing Party other than by the breach of an obligation of confidentiality owed to Disclosing Party and without confidentiality restrictions on use and disclosure; or (iv) is independently developed by Receiving Party.

(c) "Confidential Materials" shall mean all tangible materials containing Confidential Information, including without limitation written or printed documents and computer disks or tapes, whether machine or user readable.

## **2. Restrictions**

(a) Each party shall treat as confidential the Contract and any and all information ("confidential information") obtained from the other pursuant to the Contract and shall not divulge such information to any person (except to such party's "Covered Person" which term shall mean employees, contingent workers and professional advisers of a party who need to know the same) without the other party's written consent provided that this clause shall not extend to information which was rightfully in the possession of such party prior to the commencement of the negotiations leading to the Contract, which is already public knowledge or becomes so at a future date (otherwise than as a result of a breach of this clause). Receiving Party will have executed or shall execute appropriate written agreements with Covered Person, sufficient to enable it to comply with all the provisions of this Agreement. If Service Provider appoints any Sub-Contractor (if allowed) then Service Provider may disclose confidential information to such Sub-Contractor subject to such Sub Contractor giving the Bank an undertaking in similar terms to the provisions of this clause. Any breach of this Agreement by Receiving Party's Covered Person or Sub-Contractor shall also be constructed a breach of this Agreement by Receiving Party.

(b) Receiving Party may disclose Confidential Information in accordance with judicial or other governmental order to the intended recipients (as detailed in this clause), provided Receiving Party shall give Disclosing Party reasonable notice (provided not restricted

by applicable laws) prior to such disclosure and shall comply with any applicable protective order or equivalent. The intended recipients for this purpose are:

- i. the statutory auditors of the either party and
- ii. government or regulatory authorities regulating the affairs of the parties and inspectors and supervisory bodies thereof

(c) Confidential Information and Confidential Material may be disclosed, reproduced, summarized or distributed only in pursuance of Receiving Party's business relationship with Disclosing Party, and only as otherwise provided hereunder. Receiving Party agrees to segregate all such Confidential Material from the confidential material of others in order to prevent mixing.

## **2. Rights and Remedies**

(a) Receiving Party shall notify Disclosing Party immediately upon discovery of any unauthorized use or disclosure of Confidential Information and/ or Confidential Materials, or any other breach of this Agreement by Receiving Party and will cooperate with Disclosing Party in every reasonable way to help Disclosing Party regain possession of the Confidential Information and/ or Confidential Materials and prevent its further unauthorized use.

(b) Receiving Party shall return all originals, copies, reproductions and summaries of Confidential Information or Confidential Materials at Disclosing Party's request, or at Disclosing Party's option, certify destruction of the same.

(c) Receiving Party acknowledges that monetary damages may not be the only and / or a sufficient remedy for unauthorized disclosure of Confidential Information and that disclosing party shall be entitled, without waiving any other rights or remedies (including but not limited to as listed below), to injunctive or equitable relief as may be deemed proper by a Court of competent jurisdiction.

- i. Suspension of access privileges
- ii. Change of personnel assigned to the job
- iii. Termination of contract

(d) Disclosing Party may visit Receiving Party's premises, with reasonable prior notice and during normal business hours, to review Receiving Party's compliance with the term of this Agreement.

## **4. Miscellaneous**

(a) All Confidential Information and Confidential Materials are and shall remain the sole property of Disclosing Party. By disclosing information to Receiving Party, Disclosing Party does not grant any expressed or implied right to Receiving Party to disclose information

under the Disclosing Party's patents, copyrights, trademarks, or trade secret information.

(b) Confidential Information made available is provided "As Is," and disclosing party disclaims all representations, conditions and warranties, express or implied, including, without limitation, representations, conditions or warranties of accuracy, completeness, performance, fitness for a particular purpose, satisfactory quality and merchantability provided same shall not be construed to include fraud or wilful default of disclosing party.

(c) Neither party grants to the other party any license, by implication or otherwise, to use the Confidential Information, other than for the limited purpose of evaluating or advancing a business relationship between the parties, or any license rights whatsoever in any patent, copyright or other intellectual property rights pertaining to the Confidential Information.

(d) The terms of Confidentiality under this Agreement shall not be construed to limit either party's right to independently develop or acquire product without use of the other party's Confidential Information. Further, either party shall be free to use for any purpose the residuals resulting from access to or work with such Confidential Information, provided that such party shall maintain the confidentiality of the Confidential Information as provided herein. The term "residuals" means information in non-tangible form, which may be retained by person who has had access to the Confidential Information, including ideas, concepts, know-how or techniques contained therein. Neither party shall have any obligation to limit or restrict the assignment of such persons or to pay royalties for any work resulting from the use of residuals. However, the foregoing shall not be deemed to grant to either party a license under the other party's copyrights or patents.

(e) This Agreement constitutes the entire agreement between the parties with respect to the subject matter hereof. It shall not be modified except by a written agreement dated subsequently to the date of this Agreement and signed by both parties. None of the provisions of this Agreement shall be deemed to have been waived by any act or acquiescence on the part of Disclosing Party, its agents, or employees, except by an instrument in writing signed by an authorized officer of Disclosing Party. No waiver of any provision of this Agreement shall constitute a waiver of any other provision(s) or of the same provision on another occasion.

(f) In case of any dispute, both the parties agree for neutral third-party arbitration. Such arbitrator will be jointly selected by the two parties and he / she may be an auditor, lawyer, consultant or any other person of trust. The said proceedings shall be conducted in English language at Mumbai and in accordance with the provisions of Indian Arbitration and Conciliation Act 1996 or any Amendments or Re-enactments thereto. Nothing in this clause prevents a party from having recourse to a court of competent jurisdiction for the sole purpose of seeking a preliminary injunction or any other

provisional judicial relief it considers necessary to avoid irreparable damage. This Agreement shall be governed by and construed in accordance with the laws of Republic of India. Each Party hereby irrevocably submits to the exclusive jurisdiction of the courts of Mumbai.

(g) Subject to the limitations set forth in this Agreement, this Agreement will inure to the benefit of and be binding upon the parties, their successors and assigns.

(h) If any provision of this Agreement shall be held by a court of competent jurisdiction to be illegal, invalid or unenforceable, the remaining provisions shall remain in full force and effect.

(i) The Agreement shall be effective from \_\_\_\_\_ ("Effective Date") and shall be valid for a period of \_\_\_\_\_ year(s) thereafter (the "Agreement Term"). The foregoing obligations as to confidentiality shall survive the term of this Agreement and for a period of five (5) years thereafter provided confidentiality obligations with respect to individually identifiable information, customer's data of Parties or software in human-readable form (e.g., source code) shall survive in perpetuity.

### 5. Suggestions and Feedback

Either party from time to time may provide suggestions, comments or other feedback to the other party with respect to Confidential Information provided originally by the other party (hereinafter "feedback"). Both parties agree that all Feedback is and shall be entirely voluntary and shall not in absence of separate agreement, create any confidentially obligation for the receiving party. However, the Receiving Party shall not disclose the source of any feedback without the providing party's consent. Feedback shall be clearly designated as such and, except as otherwise provided herein, each party shall be free to disclose and use such Feedback as it sees fit, entirely without obligation of any kind to other party. The foregoing shall not, however, affect either party's obligations hereunder with respect to Confidential Information of other party.

Dated this \_\_\_\_\_ day of \_\_\_\_\_ (Month) 20\_\_ at \_\_\_\_\_(place)

For and on behalf of \_\_\_\_\_

NAME		
DESIGNATION		
PLACE		
SIGNATURE		

For and on behalf of \_\_\_\_\_

NAME		
DESIGNATION		
PLACE		
SIGNATURE		

**Appendix-L**  
**PRE-BID QUERY FORMAT**  
 (To be filled in E- Tendering site and in excel format)

VENDOR NAME	SL. NO.	RFP PAGE NO.	RFP CLAUSE NO.	RFP CLAUSE HEADIN G	EXISTIN G CLAUSE	QUERY/SUGGESTION S

**Queries submitted earlier i.e. up to 24/08/2023 are considered and will be responded by the Bank. Hence only additional queries, if any, needs to be submitted by the Bidder.**



**Appendix-M**

**FORMAT FOR SUBMISSION OF CLIENT REFERENCES**

(Applicable to bidder(s) which are not engaged with SBI under “Per Transaction Rate Model”)

(As on 31.03.2023)

**To whosoever it may concern**

<u>PARTICULARS</u>	<u>DETAILS</u>
CLIENT INFORMATION	
CLIENT NAME	
CLIENT ADDRESS	
<del>NAME OF THE CONTACT PERSON AND DESIGNATION</del>	
<del>PHONE NUMBER OF THE CONTACT PERSON</del>	
<del>E-MAIL ADDRESS OF THE CONTACT PERSON</del>	
<b>PROJECT DETAILS</b>	
<del>NAME OF THE PROJECT</del>	
<del>START DATE</del>	
<del>END DATE</del>	
<del>CURRENT STATUS (IN PROGRESS / COMPLETED)</del>	
<del>SIZE OF PROJECT</del>	
<del>VALUE OF WORK ORDER (IN LAKH) (ONLY SINGLE WORK ORDER)</del>	
<del>Details i.e., Quantity of Work order, number of machines etc. (in numbers)</del>	

**Name & Signature of authorised signatory**

**Seal of Client**

**Appendix-N**  
**PRE-CONTRACT INTEGRITY PACT**  
**(TO BE STAMPED AS AN AGREEMENT)**

General

This pre-Bid pre-contract Agreement (hereinafter called the Integrity Pact) is made on \_\_\_\_\_ day of the \_\_\_\_\_ <<month>> of 2023 , between, on the one hand, the State Bank of India, a body corporate incorporated under the State Bank of India Act, 1955 having its Corporate Centre at State Bank Bhavan, Nariman Point, Mumbai through its **Anytime Channels Department at, 3<sup>rd</sup> floor, World Trade Centre, Cuffe Parade, Mumbai 400005 (procuring office address)** (hereinafter called the "BUYER", which expression shall mean and include, unless the context otherwise requires, its successors) of the First Part

And

M/s \_\_\_\_\_ represented by Shri \_\_\_\_\_, Chief Executive Officer/ Authorised signatory (hereinafter called the "BIDDER/Seller which expression shall mean and include, unless the context otherwise requires, its / his successors and permitted assigns of the Second Part.

WHEREAS the BUYER proposes to procure **SERVICES OF \_\_\_\_\_ ATMs UNDER TOTAL OUTSOURCED MODEL (TOM) ON PER SUCCESSFUL TRANSACTION BASIS** – (Name of the Stores/Equipment/Item) and the BIDDER/Seller is willing to offer the sought services

and;

WHEREAS the BIDDER is a private company/public company/Government undertaking/partnership/registered export agency, constituted in accordance with the relevant law in the matter and the BUYER is an Office / Department of State Bank of India performing its functions on behalf of State Bank of India.

NOW, THEREFORE,

To avoid all forms of corruption by following a system that is fair, transparent and free from any influence/prejudiced dealings prior to, during and subsequent to the currency of the contract to be entered into with a view to:

Enabling the BUYER to obtain the desired service / product at a competitive price in conformity with the defined specifications by avoiding the high cost and the distortionary impact of corruption on public procurement; and

Enabling BIDDERS to abstain from bribing or indulging in any corrupt practice in order to secure the contract by providing assurance to them that their competitors will also abstain from bribing and other corrupt practices and the BUYER will commit to prevent corruption, in any form, by its officials by following transparent procedures.

The parties hereto hereby agree to enter into this Integrity Pact and agree as follows:

#### **1. Commitments of the BUYER**

1.1 The BUYER undertakes that no official of the BUYER, connected directly or indirectly with the contract, will demand, take a promise for or accept, directly or through intermediaries, any bribe, consideration, gift, reward, favour or any material or immaterial benefit or any other advantage from the BIDDER, either for themselves or for any person, organisation or third party related to the contract in exchange for an advantage in the bidding process, Bid evaluation, contracting or implementation process related to the contract.

1.2 The BUYER will, during the pre-contract stage, treat all BIDDERS alike, and will provide to all BIDDERS the same information and will not provide any such information to any particular BIDDER which could afford an advantage to that particular BIDDER in comparison to other BIDDERS.

2.1 All the officials of the BUYER will report to the appropriate authority any attempted or completed breaches of the above commitments as well as any substantial suspicion of such a breach.

1.4 In case any such preceding misconduct on the part of such official(s) is reported by the BIDDER to the BUYER with full and verifiable facts and the same is prima facie found to be correct by the BUYER, necessary disciplinary proceedings, or any other action as deemed fit, including criminal proceedings may be initiated by the BUYER and such a person shall be debarred from further dealings related to the contract process. In such a case while an enquiry is being conducted by the BUYER the proceedings under the contract would not be stalled.

## **2. Commitments of BIDDERS**

2.1 The BIDDER commits itself to take all measures necessary to prevent corrupt practices, unfair means and illegal activities during any stage of its Bid or during any pre-contract or post-contract stage in order to secure the contract or in furtherance to secure it and in particular commit itself to the following:

2.2 The BIDDER will not offer, directly or through intermediaries, any bribe, gift, consideration, reward, favour, any material or immaterial benefit or other advantage, commission, fees, brokerage or inducement to any official of the BUYER, connected directly or indirectly with the bidding process, or to any person, organisation or third party related to the contract in exchange for any advantage in the bidding, evaluation, contracting and implementation of the contract.

2.3 The BIDDER further undertakes that it has not given, offered or promised to give, directly or indirectly any bribe, gift, consideration, reward, favour, any material or immaterial benefit or other advantage, commission, fees, brokerage or inducement to any official of the BUYER or otherwise in procuring the Contract or forbearing to do or having done any act in relation to the obtaining or execution of the contract or any other contract with State Bank of India for showing or forbearing to show favour or disfavour to any person in relation to the contract or any other contract with State Bank of India.

2.4 Wherever applicable, the BIDDER shall disclose the name and address of agents and representatives permitted by the Bid documents and Indian BIDDERS shall disclose their foreign principals or associates, if any.

2.5 The BIDDER confirms and declares that they have not made any payments to any agents/brokers or any other intermediary, in connection with this Bid/contract.

2.6 The BIDDER further confirms and declares to the BUYER that the BIDDER is the original vendors or service providers in respect of product / service covered in the Bid documents and the BIDDER has not engaged any individual or firm or company whether Indian or foreign to intercede, facilitate or in any way to recommend to the BUYER or any of its functionaries, whether officially or unofficially to the award of the contract to the BIDDER, nor has any amount been paid, promised or intended to be paid to any such individual, firm or company in respect of any such intercession, facilitation or recommendation.

2.7 The BIDDER, at the earliest available opportunity, i.e. either while presenting the Bid or during pre-contract negotiations and in any case before opening the financial Bid and before signing the contract, shall disclose any payments he has made, is committed to or intends to make to officials of the BUYER or their family members, agents, brokers or any other intermediaries in connection with the contract and the details of services agreed upon for such payments.

2.8 The BIDDER will not collude with other parties interested in the contract to impair the transparency, fairness and progress of the bidding process, Bid evaluation, contracting and implementation of the contract.

2.9 The BIDDER will not accept any advantage in exchange for any corrupt practice, unfair means and illegal activities.

2.10 The BIDDER shall not use improperly, for purposes of competition or personal gain, or pass. on 'to° others, any -information provided by the BUYER as part of the business relationship, regarding plans, technical proposals and business details, including information contained in any electronic data carrier. The BIDDER also undertakes to exercise due and adequate care lest any such information is divulged.

2.11 The BIDDER commits to refrain from giving any complaint directly or through any other manner without supporting it with full and verifiable facts.

2.12 The BIDDER shall not instigate or cause to instigate any third person to commit any of the actions mentioned above.

2.13 If the BIDDER or any employee of the BIDDER or any person acting on behalf of the BIDDER, either directly or indirectly, is a relative of any of the officers of the BUYER, or alternatively, if any relative of an officer of the BUYER has financial Interest/stake in the BIDDER's firm, the same shall be disclosed by the BIDDER at the time of filing of tender. The term 'relative' for this purpose would be as defined in Section 6 of the Companies Act 1956.

2.14 The BIDDER shall not lend to or borrow any money from or enter into any monetary dealings or transactions, directly or indirectly, with any employee of the BUYER.

### **3. Previous Transgression**

3.1 The BIDDER declares that no previous transgression occurred in the last three years immediately before signing of this Integrity Pact, with any other company in any country in respect of any corrupt practices envisaged hereunder or with any Public Sector Enterprise / Public Sector Banks in India or any Government Department in India or RBI that could justify BIDDER's exclusion from the tender process.

3.2 The BIDDER agrees that if it makes incorrect statement on this subject, BIDDER can be disqualified from the tender process or the contract, if already awarded, can be terminated for such reason.

### **4. Earnest Money (Security Deposit)**

4.1 While submitting commercial Bid, the BIDDER shall deposit an amount (specified in RFP) as Earnest Money/Security Deposit, with the BUYER through any of the mode mentioned in the RFP / Bid document and no such mode is specified, by a Bank Draft

or a Pay Order in favour of State Bank of India from any Bank including SBI. However, payment of any such amount by way of Bank Guarantee, if so permitted as per Bid documents / RFP should be from any Scheduled Commercial Bank other than SBI and promising payment of the guaranteed sum to the BUYER on demand within three working days without any demur whatsoever and without seeking any reasons whatsoever. The demand for payment by the BUYER shall be treated as conclusive proof for making such payment to the BUYER.

4.2 Unless otherwise stipulated in the Bid document / RFP, the Earnest Money/Security Deposit shall be valid upto a period of five years or the complete conclusion of the contractual obligations to the complete satisfaction of both the BIDDER and the BUYER, including warranty period, whichever is later.

4.3 In case of the successful BIDDER a clause would also be incorporated in the Article pertaining to Performance Bond in the Purchase Contract that the provisions of Sanctions for Violation shall be applicable for forfeiture of Performance Bond in case of a decision by the BUYER to forfeit the same-without assigning any reason for imposing sanction for violation of this Pact.

4.4 No interest shall be payable by the BUYER to the BIDDER on Earnest Money/Security Deposit for the period of its currency.

## **5. Sanctions for Violations**

5.1 Any breach of the aforesaid provisions by the BIDDER or anyone employed by it or acting on its behalf (whether with or without the knowledge of the BIDDER) shall entitle the BUYER to take all or any one of the following actions, wherever required:

(i) To immediately call off the pre-contract negotiations without assigning any reason and without giving any compensation to the BIDDER. However, the proceedings with the other BIDDER(s) would continue, unless the BUYER desires to drop the entire process.

(ii) The Earnest Money Deposit (in pre-contract stage) and/or Security Deposit/Performance Bond (after the contract is signed) shall stand forfeited either fully or partially, as decided by the BUYER and the BUYER shall not be required to assign any reason therefore.

(iii) To immediately cancel the contract, if already signed, without giving any compensation to the BIDDER.

(iv) To recover all sums already paid by the BUYER, and in case of an Indian BIDDER with interest thereon at 2% higher than the prevailing Base Rate of State Bank of India, while in case of a BIDDER from a country other than India with interest thereon at 2% higher than the LIBOR. If any outstanding payment is due to the BIDDER from the BUYER in connection with any other contract for any other stores, such outstanding could also be utilized to recover the aforesaid sum and interest.

(v) To encash the advance bank guarantee and performance bond/warranty bond, if furnished by the BIDDER, in order to recover the payments, already made by the BUYER, along with interest.

(vi) To cancel all or any other Contracts with the BIDDER. The BIDDER shall be liable to pay compensation for any loss or damage to the BUYER resulting from such cancellation/rescission and the BUYER shall be entitled to deduct the amount so payable from the money(s) due to the BIDDER.

(vii) To debar the BIDDER from participating in future bidding processes of the BUYER or any of its Subsidiaries for a minimum period of five years, which may be further extended at the discretion of the BUYER.

(viii) To recover all sums paid, in violation of this Pact, by BIDDER(s) to any middleman or agent or broker with a view to securing the contract.



(ix) Forfeiture of Performance Bond in case of a decision by the BUYER to forfeit the same without assigning any reason for imposing sanction for violation of this Pact.

(x) Intimate to the CVC, IBA, RBI, as the BUYER deemed fit the details of such events for appropriate action by such authorities.

5.2 The BUYER will be entitled to take all or any of the actions mentioned at para 5.1(i) to (x) of this Pact also on the Commission by the BIDDER or any one employed by it or acting on its behalf (whether with or without the knowledge of the BIDDER), of an offence as defined in Chapter IX of the Indian Penal code, 1860 or Prevention of Corruption Act, 1988 or any other statute enacted for prevention of corruption.

5.3 The decision of the BUYER to the effect that a breach of the provisions of this Pact has been committed by the BIDDER shall be final and conclusive on the BIDDER. However, the BIDDER can approach the Independent Monitor(s) appointed for the purposes of this Pact.

## **6. Fall Clause**

The BIDDER undertakes that it has not supplied/is not supplying similar product/systems or subsystems at a price lower than that offered in the present Bid in respect of any other Ministry/Department of the Government of India or PSU or any other Bank and if it is found at any stage that similar product/systems or sub systems was supplied by the BIDDER to any other Ministry/Department of the Government of India or a PSU or a Bank at a lower price, then that very price, with due allowance for elapsed time, will be applicable to the present case and the difference in the cost would be refunded by the BIDDER to the BUYER, if the contract has already been concluded.

## 7. Independent Monitors

7.1 The BUYER has appointed Independent Monitors (hereinafter referred to as Monitors) for this Pact in consultation with the Central Vigilance Commission (Names and Addresses of the Monitors to be given).

Ms. Minnie Mathew IAS (Retd.) Minniethew635@gmail.com	Shri Otem Dai IAS (Retd.) Mobile No. 9402277510 otemdai@hotmail.com
---	---

7.2 The task of the Monitors shall be to review independently and objectively, whether and to what extent the parties comply with the obligations under this Pact.

7.3 The Monitors shall not be subjected to instructions by the representatives of the parties and perform their functions neutrally and independently.

7.4 Both the parties accept that the Monitors have the right to access all the documents relating to the project/procurement, including minutes of meetings. Parties signing this Pact shall not approach the Courts while representing the matters to Independent External Monitors and he/she will await their decision in the matter.

7.5 As soon as the Monitor notices, or has reason to believe, a violation of this Pact, he will so inform the Authority designated by the BUYER.

7.6 The BIDDER(s) accepts that the Monitor has the right to access without restriction to all Project documentation of the BUYER including that provided by the BIDDER. The BIDDER will also grant the Monitor, upon his request and demonstration of a valid interest, unrestricted and unconditional access to his project documentation. The same is applicable to Subcontractors. The Monitor shall be under contractual obligation to treat the information and documents of the BIDDER / Subcontractor(s) with confidentiality.

7.7 The BUYER will provide to the Monitor sufficient information about all meetings among the parties related to the Project provided such meetings could have an impact

on the contractual relations between the parties. The parties will offer to the Monitor the option to participate in such meetings.

7.8 The Monitor will submit a written report to the designated Authority of BUYER/Secretary in the Department/ within 8 to 10 weeks from the date of reference or intimation to him by the BUYER / BIDDER and, should the occasion arise, submit proposals for correcting problematic situations.

#### **8. Facilitation of Investigation**

In case of any allegation of violation of any provisions of this Pact or payment of commission, the BUYER or its agencies shall be entitled to examine all the documents including the Books of Accounts of the BIDDER and the BIDDER shall provide necessary information and documents in English and shall extend all possible help for the purpose of such examination.

#### **9. Law and Place of Jurisdiction**

This Pact is subject to Indian Law. The place of performance and jurisdiction is the seat of the BUYER.

#### **10. Other Legal Actions**

The actions stipulated in this Integrity Pact are without prejudice to any other legal action that may follow in accordance with the provisions of the extant law in force relating to any civil or criminal proceedings.

#### **11. Validity**

11.1 The validity of this Integrity Pact shall be from date of its signing and extend upto 5 years or the complete execution of the contract to the satisfaction of both the BUYER and the BIDDER/Seller, including warranty period, whichever is later. In case BIDDER is unsuccessful, this Integrity Pact shall expire after six months from the date of the signing of the contract, with the successful Bidder by the BUYER.

11.2 Should one or several provisions of this Pact turn out to be invalid; the remainder of this Pact shall remain valid. In this case, the parties will strive to come to an agreement to their original intentions.

12. The parties hereby sign this Integrity Pact at \_\_\_\_\_ on \_\_\_\_\_

For BUYER

Name of the Officer.

Designation

Office / Department / Branch

State Bank of India.

Witness

1

2

For BIDDER

Chief Executive Officer/

Authorised Signatory

Designation

Witness

1.

2.

<< KYC documents of signatories including Witnesses to be submitted with this Pact >>

**Note: This agreement will require stamp duty as applicable in the State where it is executed or stamp duty payable as per Maharashtra Stamp Act, whichever is higher.**

## APPENDIX-O

### MANUFACTURERS' AUTHORIZATION FORM FOR ATMs

(To be submitted for each proposed model)

No.  
To:

Date:

Dear Sir,

**Ref: RFP No. SBI/AC/2023-24/003 dated: 17/08/2023**

We, who are established and reputable manufacturers / producers of endpoints (ATMs/ CDMs / ADWMs - Cash Recyclers) having factories / development facilities at \_\_\_\_\_ (address of factory / facility) do hereby authorize M/s \_\_\_\_\_ (Name and address of Agent "Vendor") to submit a Bid for model \_\_\_\_\_, and sign the contract with you against the above Bid Invitation. Our \_\_\_\_\_ model is proposed for this bid. This model has:

Operating System (OS) version with Service Pack details	
Complete Processor details	
RAM capacity & type	
No. of extra RAM slots available in motherboard and maximum RAM capacity upgrade possible	
Harddisk capacity & type	
Each key of EPP / Keypad and FDK (if any) has Braille embossing	<Specify YES / NO>

**2.** We hereby extend our full warranty for the Equipment, Software Solution and Services supplied by us, which is offered by the above firm against this Bid Invitation, as agreed with the Vendor under the RFP.

**3.** We also undertake to provide any or all of the following materials, notifications, and information pertaining to the equipment and software solution supplied by us and distributed by the Vendor:

(a) Such equipment as the Bank may opt to purchase from the Vendor, provided, that this option shall not relieve the Vendor of any warranty obligations under the Contract; and

(b) In the event of termination of production of such equipment:

(i) Advance notification to the Bank of the pending termination, in sufficient time to permit the Bank to procure needed requirements; and

(ii) Following such termination, furnishing at no cost to the Bank, operations manuals, standards, and specifications of the equipment, if requested.

4. We confirm that the installations, technical support and maintenance obligations required by the contract for the equipment and software solutions supplied by us and distributed by the vendor will be provided by us.

5. We hereby extend our full comprehensive warranty, annual maintenance as per the terms and conditions of this RFP and the agreement / contract with the Vendor, in case M/s \_\_\_\_\_ (Our Authorized representative) emerge as the / one of the successful bidders, for the goods and services offered for supply of our authorized representative against RFP.

Countersigned:  
(Bidder)

Yours faithfully  
(Name of Manufacturer / Producer)

*Note: This letter of authority should be on the letterhead of the manufacturer and should be signed by a person competent and having the power of attorney to bind the manufacturer. The Bidder in its Bid should include it, duly countersigned.*

## Appendix-P

### Certificate for Tenders for Works under Rule 144 (xi) in the General Financial Rules (GFRs), 2017

To:

Date:

Dear Sir,

**Ref: SBI/AC/2023-24/003 dated: 17/08/2023**

**Bidder Name:**

We, .....  
are a private/public limited company / LLP / Firm <strike off whichever is not applicable>  
incorporated under the provisions of the Companies Act, 1956/ Limited Liability  
Partnership Act 2008/ Indian Partnership Act 1932 <strike off whichever is not  
applicable>, having its registered office at hereinafter referred to as "Bidder/Seller"  
which expression shall mean and include, unless the context otherwise requires, its / his  
successors and permitted assigns.

This is to certify that we have read the clauses stated in the Office Memorandum issued  
by Ministry of Finance on the Insertion of Rule 144 (xi) in the General Financial Rules  
(GFRs), 2017 dated 23 July 2020 and amendments & clarifications hereto regarding  
restrictions on procurement from a bidder of a country which shares a land border with  
India and on sub-contracting to contractors from such countries. We certify that the  
Bidder is not from such a country or, if from such a country, has been registered with  
the Competent Authority and will not sub-contract any work to a contractor from such  
countries unless such contractor is registered with the Competent Authority. We hereby  
certify that we fulfill all requirements in this regard and is eligible to be considered.

We also accept that if such certificate given by the Bidder if our bid is accepted and is  
found to be false, this would be a ground for immediate termination and further legal  
action in accordance with law.

Signature and Seal of the Bidder

Note: Where applicable, evidence of valid registration by the Competent Authority shall  
be attached.

## Appendix-Q

### RAMP Specifications:

A ramp is a sloping pathway leading from one level to another. Ramps of an appropriate design shall be provided at all changes in level other than those served by an accessible lift or accessible lifting mechanism accommodating the specific requirements of persons with disabilities.

As per non-discrimination clause of the Disabilities Act-1995, **we Bidder** has to comply with requirements of providing ramps in buildings housing its branches / offices.

#### **1. General requirements of ramps**

Ramps shall meet the following requirements in general: -

- a) Wherever the rise of a ramp exceeds 300mm, an additional flight of steps shall also be provided for ambulant persons. An isolated single step is not acceptable and hence a ramp is preferred to a single step.
- b) Where there is a large change in elevation that requires multiple ramps and landing combination, other solution such as lifts should be considered.
- c) Ramps should not ideally connect straight to doors as wheelchair users need a leveled platform at the end of the ramp to maneuver and negotiate opening the door.
- d) A curved ramp is not a preferred design solution. Similarly, a cross fall may put a wheelchair user at risk and may adversely affect steering, particularly on manually propelled chair.
- e) Shiny, polished surface materials that cause glare shall not be used for ramps.
- f) Single row of tactile warning blocks (TGS) shall be placed (as per figure) at the beginning and end of each ramp. Tactile ground surface indicators or tactile guiding and warning tiles/blocks aid blind and vision impaired pedestrians negotiate the built environment. Tactile ground surface indicators (warning type) shall be installed 300 mm before the beginning and 300 mm after the end of each flight of steps to aid people with visual impairments. This shall be placed 300 mm before the beginning and end of each ramp run to indicate the level change to visually impaired persons. Tactile warning strips shall also be provided at landings. For landings leading to a floor or those enclosed by wall, railing or balustrade, tactile warning strips of 300 mm in width shall be provided; for those leading to an open space or the entrance/exit of a building, the tactile warning strips shall be 600 mm in width.



## 2. Gradient

The gradient shall be constant between landings. The minimum specifications for ramp gradients addressing different level differences are given in table 1.

## 3. Width

The minimum clear width of a ramp (exclusive of handrails) shall be 1 200 mm and shall increase correspondingly as the level difference addressed by the ramp increases as per table 1.

SI No	Level Difference	Max. gradient of ramp	Ramp width in mm	Handrail on both sides	Other requirements
1	150mm-300mm	1:12	1200	Yes	-
2	301mm-750mm	1:12	1500	Yes	Landings at every 5 m of ramp run
3	751mm-3000mm	1:15	1800	Yes	Landings at every 9 m of ramp run
4	More than 3000mm	1:20	1800	Yes	Landings at every 9 m of ramp run

## 4. Surface

Ramps and landing surfaces shall be non-glary, smooth, level, even and slip resistant even when wet. Outdoor ramps and their surface shall be designed to prevent water from accumulating on the walking surfaces. The surface finish shall be hard and suitable for the volume of traffic that the ramp is likely to experience. An example of ramp with slope 1:20 and horizontal landings at beginning and end is illustrated in fig. 1 below.

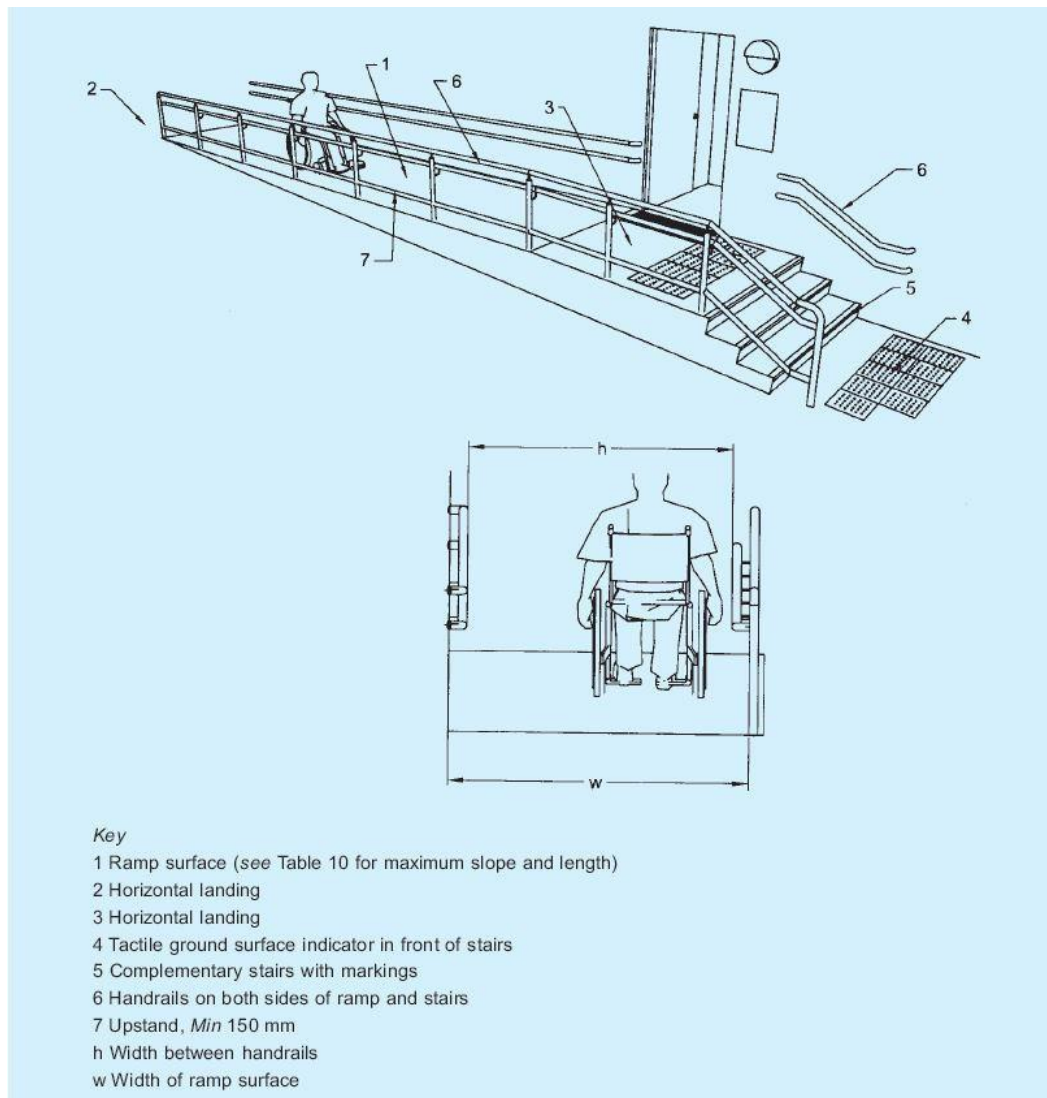

## EXAMPLES OF RAMP WITH SLOPE 1:20 AND HORIZONTAL LANDINGS AT BEGINNING AND END

### 5. Internal ramps

Internal ramps should, if possible, be avoided. Where required, internal ramps shall be designed in accordance with the following additional criteria:-

- a) No series of ramps should rise more than 2000mm in total. If this is the case, an alternative should be provided, for example a lift.
- b) An internal ramp should have the lowest practical gradient. In order to avoid trips and falls during a fire evacuation, a gradient of 1:15 should be the maximum permissible gradient within a building.
- c) The minimum illumination at the top and bottom of the ramp should be 200 lux and 150 lux in between bottom and top.

## 6. Landings

An end landing shall be provided at the bottom and the top of a sloped path, a stepped path, or a ramp and also where the run changes direction. The area of the end landing may be a part of the continuing path (See fig 2 below). The length of an end landing and an intermediate landing shall be not less than 1 500 mm. Where the ramp run changes direction, the minimum landing dimensions shall be 1 500 mm × 1 500 mm. The area of a landing shall be clear of any obstruction including the path of swing of a door or a gate.

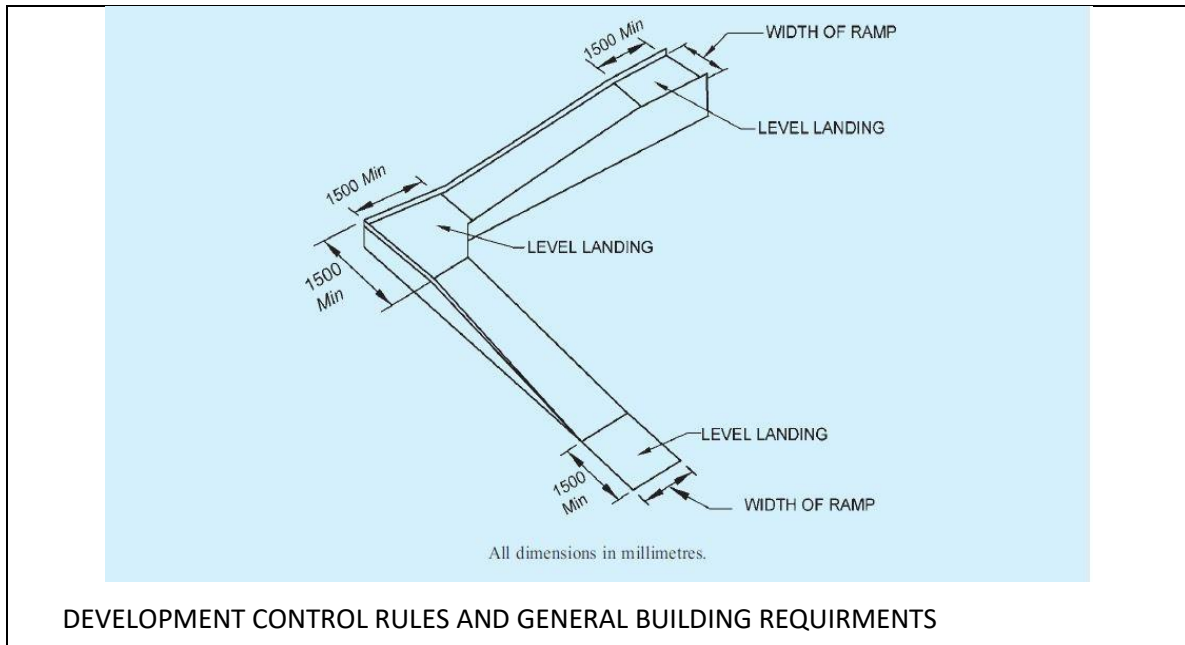

Landings shall also be provided at regular intervals of not more than 9 000 mm of every horizontal run. It shall conform to other provisions of this annex if served by a doorway. If the end landing follows or precedes a turn for a pathway or an entrance, the minimum dimension of the landing shall be minimum 1 500 mm × 1 500 mm.

The width of ramp and consequently the dimension of landing in the direction perpendicular to the direction of ramp shall also be governed by the provisions of Table 1.

## 7. Handrails for Ramps

A ramp run with a vertical rise greater than 150 mm shall have handrails that are on both the sides and comply with the following conditions:-

- They shall be provided on both the sides;
- They shall be continuous, even at the landings;
- They shall extend at least 300 mm beyond the first and last nosing. A handrail shall not project into a transverse circulation path unless it is

continuous and intended to form part of the guidance along that path. The end of the horizontal extension should be turned towards the wall on the closed side of the ramp or stairs or be turned down and terminate at the floor or ground level.

- d) They shall have a minimum clear space of 50 mm from the walls; and
- e) The height to the top of a handrail shall be between 850 mm and 950 mm above the surface of a ramp, the pitch line of a stair, and the surface of a landing. A second handrail, with a lower profile than the first one, shall be provided. The height to the top of the second handrail should be between 650 mm and 750 mm above the surface of a ramp, the pitch line of a stair, and the surface of a landing. There shall be sufficient distance between the two handrails (say, 200 mm).
- f) In case the handrail is enclosed in a recess, the recess shall extend at least 450 mm above the top of the rail.
- g) Handrails/ grab bars are extremely important features and must be designed to be easy to grasp and to provide a firm and comfortable grip so that the hand can slide along the rail without obstruction.
- h) Many Persons with Disabilities and elderly rely upon handrails/ grab bars to maintain balance or prevent serious falls.
- i) Handrails may be provided with Braille/ tactile markings at the beginning and the end to give information to people with visual impairment.

Handrail should:-

- be slip-resistant with round ends;
- have a circular section of 38-45 mm in diameter;
- have a minimum clear space of 50 mm from the walls;
- be free of any sharp or abrasive elements; and
- have continuous gripping surfaces, without interruptions or obstructions that can break a hand hold.

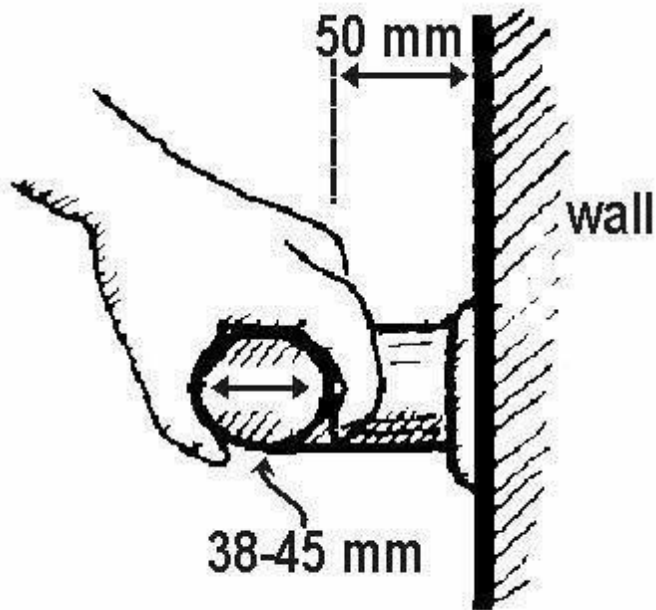

### Grab bar details



### Handrail with Braille Information Panel

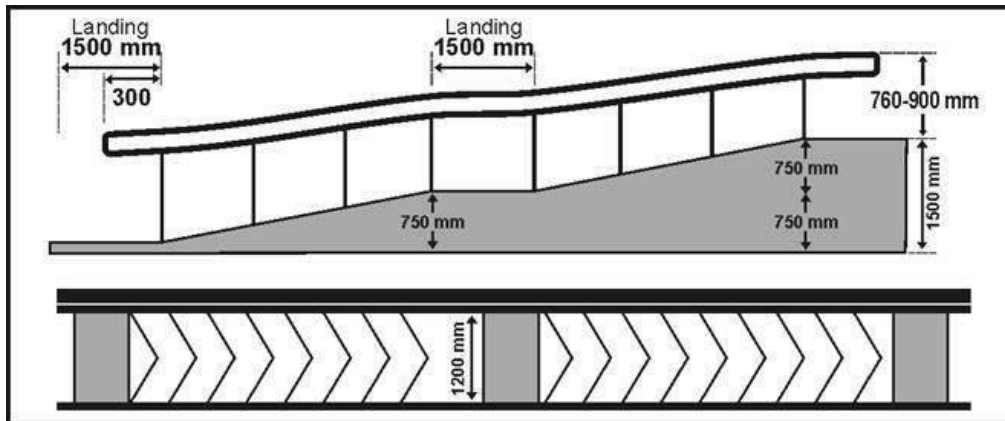

### Handrail for ramps

Grab bars/ rails should be manufactured from a material which contrasts with the wall finish (or use dark tiles behind light coloured rails), be not too warm/cold to the touch and provide good grip. It is essential that all grab rails are adequately fixed, since considerable pressure will be placed on the rail during manoeuvring. In rural areas,

indigenous materials such as bamboo/ wood/ other can be used for making grab bars in toilets.

Grab bars should: -

- be slip-resistant with round ends;
- preferably have knurled surfaces;
- have a circular section of 38-45 mm in diameter;
- be free of any sharp or abrasive elements;
- have a minimum clear space of 50 mm from the wall;
- be installed at a height of 760 mm to 900 mm; □ be able to bear a weight of 250 kg.

### 8. Edge Protection / Guarding Along Ramps

Ramps and landings not adjacent to a wall should have an edge protection in form of a 75 mm kerb. Providing protection at the side of the path protects people who use wheelchairs and ambulant people from injuring themselves as the result.

### 9. Clear floor space

- A clear and level floor space of at least 900 mm x 1200 mm should be provided at controls and operating mechanisms designated for use by Persons with Disabilities.
- Where a forward approach is used, a clear knee space of at least 900 mm wide, 480 mm deep and 650 mm high should be provided, which may overlap the clear floor space by a maximum of 480 mm.

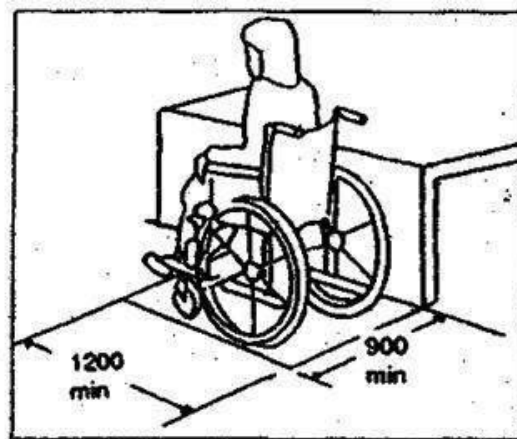
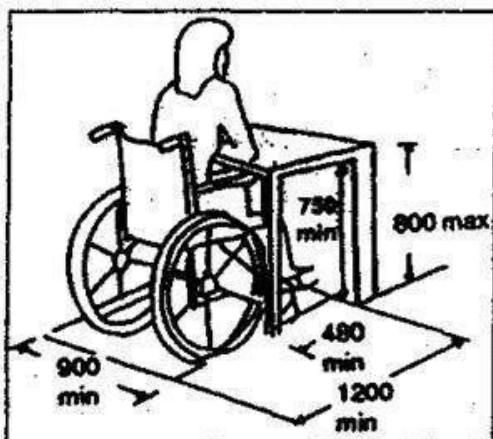

Space clearance for control operations

## **10. Buildings where ramps are not feasible**

It may not be feasible to construct ramps as per the above specifications at certain branches / offices, reasons for which are given below: -

- i) Branch entrance as well as road are at same level
- ii) Not enough space to construct ramp due to the following: -
  - a. Entrance very close to branch
  - b. Narrow Entrance
  - c. Height of entrance is very high
- iii) Branches in commercial complex / institutes / Defence establishments (where construction of ramp is a challenge).
- iv) Disputes with landlords
- v) Branches on 1<sup>st</sup> floor without lift facility.

In these circumstances the Controllers and Branch Managers shall consider the following actions: -

- i) To explore possibility of obtaining another premises for Bank's branch on ground floor well before the expiry of current lease period.
- ii) To explore the possibility of merger with nearby branch as per extant guidelines of the Bank.
- iii) To communicate with existing customers who are senior citizens / DIVYANGJAN customers and advise them about the availability and benefits of 'Doorstep banking' or to switch on to nearby branch of SBI which is on ground floor and easily accessible to them
- iv) To discuss with landlords including commercial complex / institutes / Defence establishments regarding importance of ramps in a building and requesting for arrangement of ramps.
- v) Feasibility of installing lifting mechanisms instead of ramps where space constraints are there.

**Appendix-R**

**<< on letter head of bidder >>**

**Declaration of past and present litigation details**

<b>Sno.</b>	<b>Case no/ court name</b>	<b>Description of litigation</b>	<b>Parties involved</b>	<b>Current status</b>	<b>Supporting documents</b>

Authorized signatory with Seal



**Appendix-S:**  
**Bidder Declaration**

To

The Deputy General Manager (I&R),  
State Bank of India,  
Corporate Centre,  
Anytime Channels Dept.,  
3<sup>rd</sup> Floor, World Trade Centre Arcade,  
Cuffe Parade, Mumbai – 400005.

Dear Sir,

Ref: RFP No.: **SBI/AC/2023-24/003 dated: 17/08/2023**

We have examined the above RFP, the receipt of which is hereby duly acknowledged and subsequent pre-Bid clarifications/ modifications / revisions, if any, furnished by the Bank and we offer to provide Services including supply, test, integrate, Install, commission, upgrade and support the desired equipment, Multi-Vendor Software / Agent, endpoints protection solutions / Agent, Online Monitoring Solutions/Agent and support services etc. detailed in this RFP. We shall abide by the terms and conditions spelt out in the RFP.

2. We are manufacturers/ authorized distributor/ partner/ agent of \_\_\_\_\_(Name of brand) ATM / ADWM having factories at \_\_\_\_\_. Our brand has \_\_\_\_\_ number of ATMs \_\_\_\_\_ and/or ADWMs \_\_\_\_\_ deployed for various banks in India/abroad.

3. We hereby certify that we have neither been blacklisted nor expelled from any project / contract nor had any contract terminated for breach by any Public Sector Undertaking /IBA/ RBI / Regulatory Authority/ Statutory Authority / Any State or Central Government / any Bank during the last five years in India or abroad.

4. (a) We hereby certify that no past / present litigations or disputes exists against our Company/firm which could adversely affect our participation under this RFP and result in the disqualification.

OR

(b) We hereby certify that past / present litigations or disputes exists against our Company / firm the brief details of which are as under:

- i. \_\_\_\_\_
- ii. \_\_\_\_\_

(NB: Please strike out either 3 (a) or 3 (b) as the case may be )

We undertake that in case due to any change in facts or circumstances during the Bidding Process, we are attracted by the provisions of disqualification in terms of the provisions of RFP, we shall intimate the Bank of the same immediately.

5. We, hereby irrevocably waive any right which we may have at any stage at law or howsoever otherwise arising to challenge or question any decision taken by the Bank in connection with the selection of bidder or in connection with the selection/bidding process itself in respect of procurement of Services including equipment, Solutions and Support Services etc.

6. We do hereby certify that we do not have any Service Level Agreement pending to be signed with the Bank for more than 6 months from the date of issue of purchase order issued by any of the Department at SBI as on the date of Bid submission.

7. We agree to provide all services etc. under this RFP for a Minimum period of seven years (with a provision to extend for 3 years at the discretion of the Bank) by deputing our suitable resources at the endpoint or elsewhere as and when required irrespective of number of visits to operationalize or to ensure uptime of endpoint or to repair or to maintain or to carry out any activity apart from preventive maintenance without any additional cost to the Bank as we will be building suitable cost factor as a part of Total cost of ownership as a part of RFP. Illustrative but not exhaustive list of activities are as under:

- Any managed service activities.
- Any hardware of endpoint replacement/troubleshooting
- Testing, installation, reinstallation, bug fixing, trouble shooting, upgradation at the endpoint in connection with Multi Vendor Agent, any endpoint protection solutions like Hard Disk encryption, White listing Solutions, any agent etc
- Supporting the Multi-Vendor Software Solutions, Endpoint Protection Solutions and Online Monitoring Solution.
- Loading of any software, any agent, any patches which could not be done through centralized patching.
- Service for loading and on-going maintenance of encryption keys;
- Service like IP address Changes, DNS Changes, TLS changes, changing currency cassettes configuration, changes combination lock setting etc
- Service during natural calamities or fire.
- Any preventable call
- As and when required by the Bank to carry out specific activity.

The aforesaid clause will hold good even if underlying model is discontinued for any reason.

8. We have dedicated Banks' ATM / ADWM Monitoring Tool for analyzing full range of ATMs/ error/status codes for monitoring health of ATMs/ with automated on-line problem ticketing, call logging, call transfer/escalation (by SMS, email, voice, etc.), follow up till satisfactory closure of ticket, forecasting optimum cash requirements to the Cash Dispenser branch and providing wide ranging MIS for each Cash Recycler for meaningful analysis of performance, including Reports for connected vendors SLAs. We, further, confirm that our central monitoring tools is compatible

with Base24 and can be integrated with Banks' ATM / Monitoring Tool. In addition, in case, if our Monitoring system is not integrated with Banks' Monitoring tool, we undertake to integrate same with Banks' Monitoring Tool within a month, on intimation in this regard by Bank to us. If required, we undertake to be demonstrate to the Bank's satisfactions at our cost. Further, we undertake to use the Online Monitoring Solutions if provided by the Bank and make required lease line and backup connectivity between our Managed Service Centers and its DR Center to Banks' DC and DR at our cost with network redundancy and note to bear the related recurring expenditure.

9. As a part of contract, we undertake to provide endpoint (ATMs) at DC location and note to service the said equipment and provide engineer having full knowledge of endpoint as and when required without any additional cost.

10. We, undertake, to upgrade the Operating System and associated hardware components to latest available without any additional cost to the Bank, if Operating System supplied is declared out of date/end of support.

11. We undertake to ensure that in case of installation against replacement, the Hard Disk Drive of the equipment supplied will be handed over to the Branch head / his representative and this will be recorded in the installation report to be signed by our representative and Bank. We also give an undertaking that the integrity of the data on the Hard Disk will not be compromised and put to any misuse, causing financial or reputational loss to the Bank.

12. We give an undertaking that disposal process of the old equipment will be handled properly with a view to protecting the environment, reducing pollution by toxic gases / green house emissions and other non-biodegradable substances caused by e-waste disposal.

13. RFP requires decommissioning / regrouting, lifting, shifting and disposal of the existing endpoint as per the e-waste disposal policy of the bank without any additional cost to the Bank.

14. We also certify that in the event of we becoming one of the successful bidders, the model of ATMs to be supplied by us are capable of running Multi-Vendor Software (MVS) and Endpoint Security Solution (EPS), OMS and other software(s) being procured by the Bank without any hardware changes. We undertake the responsibility for testing, integrating, commissioning and coordinating implementation of the MVS & EPS to the ATMs to be supplied by us, without any extra cost to the Bank.

15. We hereby, irrevocably and unconditionally undertake to extend all supports (including, XFS CD Version 3.1 and above, documents, operations manuals, standards, binaries and specification of said models with its components, physical devices and its drivers) as and when required without any deviation, without any additional cost and shall work in coordination, collaboratively and cohesively with the Bank selected Solution Provider during the pre-implementation, integration, testing, pilot run, rollout/implementation, installation and post implementation support relating to solutions (i.e. Multi-Vendor Software, Endpoint Protection, Online Monitoring Solutions, any other agent at the client etc) in respect of our endpoints supplied to the Bank or being supplied under this RFP, to ensure that solutions to be procured

runs on our endpoint supplied without any impact and render all support required to ensure that endpoint remains up and running successfully during the currency of existing agreement.

Yours faithfully,

Signature and Seal of Bidder

**Appendix-S1**  
**(This certificate is to be on the letterhead of the Client)**

(As on 31.03.2023)

**To whom so ever it may concern**

This is to certify that \_\_\_\_\_ [Name of OEM / Bidder] have successfully deployed \_\_\_\_\_(nos.) ATMs (Cash Dispensers) of **below mentioned make & model of \_\_\_\_\_ [Name of OEM]** under per transaction business model / rental model and are working to our Satisfaction, since \_\_\_\_\_, the details of which are furnished as under :

Make	Type of Endpoint (ATM / CD)	Model	No. of Terminals installed	During the period	
				From	To

The aforesaid OEM / Bidder is also providing the following support services satisfactorily:

Services	During the period (Mention Dates)	
	From	To
Maintenance Services, Cash Replenishment Services etc.		

Our coordinates for further details in this regard is as under:

Name of Official	
Designation	
Landline no	
Cell no	
Email Id	
Address	

**Signature of the Client and Seal**

**Appendix-S2:**  
**OEM Certificate**

(This certificate is to be on the letterhead of the OEM)

**To whom so ever it may concern**

This is to certify that we \_\_\_\_\_ [Name of OEM] have successfully deployed \_\_\_\_\_(Numbers) ATMs as on 31/03/2023 which are currently in working conditions in India, the details of which are furnished as under:

Name of Bank(s)	ATMs Model	No. of Terminals	During the period	
			From	To

Our coordinates for further details in this regard is as under:

Name of Official	
Designation	
Landline no	
Cell no	
Email Id	
Address	

**Signature of the OEM with Seal**

~~This is certified that the above information's are true and correct. OEM has deployed the above-mentioned Model in our Bank and are working to our satisfaction.~~

**Signature of the Client/ Bank with Seal**

**Appendix-S3: OEM Undertaking**  
**Certificate cum Letter of undertaking [OEM]**

*This letter of authority should be on the letterhead of the manufacturer and should be signed by a competent person and having the power of attorney to bind the manufacturer. The Bidder in its Bid should include it duly countersigned:*

No.

Date: <DD-MMM-YYYY>

To

The Deputy General Manager (I&R),  
State Bank of India,  
Corporate Centre,  
Anytime Channels Dept.,  
3<sup>rd</sup> floor, World Trade Centre "Arcade",  
Cuffe Parade, Mumbai – 400005.

Dear Sir,

**Ref: RFP No.: SBI/AC/2023-24/003 dated: 17/08/2023**

We, who are established and reputable manufacturers / producers of endpoints ATMs (Cash dispensers) \_\_\_\_\_(Name of the Brand) having factories / development facilities at \_\_\_\_\_(address of factory / facility) do hereby authorize M/s \_\_\_\_\_ (Name and address of Agent) to submit a Bid, and sign the contract with you against the above Bid Invitation.

2. We have deployed \_\_\_\_\_ number of ATM for various banks in India / Abroad.
3. We hereby certify that we have currently production and supply capacities of ..... ATMs per quarter for the model proposed under the RFP. We undertake to supply within 30 days of the issuance of the Purchase Order by the Bank to the bidder and also agreeable to executing an agreement with the bidder to comply with the requirements of the above RFP, as amended from time to time.
4. We, undertake to ensure full range of technology support to the Bank / bidder in respect of our equipment supplied whether it be a Hardware or Software or spare or

maintenance or troubleshooting or integration or providing drivers of various components (including part / components estimated time to failure details) or any other technical support required to ensure uptime of the equipment / endpoint during the minimum period of life span of the equipment / endpoint i.e. seven years, extendable for a period up to 10 years (i.e., upto another three years in one or more tranches after base 7 years period) at the sole discretion of the Bank.

5. We further certify that we have local presence in India having our / our Authorized Partner's Support Center in India and with a provision of highest escalation (level 3) in India/Abroad, details of which is furnished as under:

<b>A</b>	<b>The OEM or OEM's Authorized Partner should have 24x7 helpdesk support setup for endpoints</b>	
Sr.No.	Complete Address details with contact Nos.	
	Name of OEM	
1	Address	
	Email	
	Phone	
	Fax	
	Name of Head	
	Designation	
	Cell	
	No. of Team Support Members	
	Whether comply with 3 minutes Response Time?	Yes/No
	Whether comply with 15 minutes resolution time for routine issues?	Yes/No
	No. of terminals supported	
NB: Bidder may add if more than one helpdesk support.		
<b>B</b>	<b>OEM Level three (Highest escalation) Technical Support</b>	



Sr.No.	Complete Address details with contact Nos.	
	Name of OEM	
1	Address	
	Email	
	Phone	
	Fax	
	Name of Head	
	Designation	
	Cell	
	No. of Team Support Members	
	Whether comply with 3 minutes Response Time?	Yes/No
	Whether comply with 60 minutes resolution time?	Yes/No
	No. of terminals supported	
NB: Bidder may add if more than one helpdesk support.		

6. We duly authorize the said firm to act on our behalf in fulfilling all installations, technical support and maintenance obligations required by the contract.

Yours faithfully,

[Bidder counter signature]

(Name of Manufacturer / Producers)

[Duly signed / stamped Letter on the letter head of Manufacturer countersigned by Bidder]

**Appendix-S4:**

**Bidder 24x7 Helpdesk**

<b>A</b>	<b>The Bidder should have 24x7 Online Helpdesk / Management Centre Support Set up for support services.</b>	
Sr.No.	Complete Address details with contact Nos.	
1	Address	
	Email	
	Phone	
	Fax	
	Name of Head	
	Designation	
	Cell	
	No. of Team Support Members	
	Whether comply with 3 minutes response time?	
	Whether comply with 15 minutes resolution/escalation time for routine issues?	Yes/No
	No. of Terminals supported	
	No. of Support Centers in India	
NB: Bidder may add if more than one helpdesk support.		
		Signature and Seal of Bidder

**Appendix-S5: Support for MVS, EPS, OMS**  
**CONFIRMATION LETTER**

**FOR PROVIDING SUPPORT**

**FOR MVS, EPS, OMS (OF SBI) AND OTHER SOFTWARE(S) IMPLEMENTATION**

The Deputy General Manager (I&R),  
State Bank of India,  
Corporate Centre,  
Anytime Channels Dept.,  
3<sup>rd</sup> floor, World Trade Centre “Arcade”,  
Cuffe Parade, Mumbai – 400005.

Dear Sir

**IMPLEMENTATION OF MULTI-VENDOR SOFTWARE (MVS), ENDPOINT PROTECTION SOLUTION (EPS), ONLINE MONITORING SOLUTION AND OTHER SOFTWARE(S)**

1. We are fully aware that the Bank has Selected M/S CMS Info Systems Pvt Limited for providing Multi-Vendor Software (MVS), Endpoint Protection Solution (EPS), Online Monitoring Solution (OMS) **and other software(s)** through RFP Ref No.: SBI: GITC/ATM/2017-18/439 dated 10th Nov 2017.
2. Based on the existing agreements, we (OEMs / Endpoint Providers) agreed to install solutions (MVS, EPS and other agents) to be selected by the Bank, at no cost to the Bank, on all the existing endpoints supplied by the vendor to the Bank.
3. Based on the existing agreements, no charges are payable by the Bank for any software / patches / updates at the endpoints, including the quarterly visits for preventive maintenance. This will cover MVS / EPS / other agents upgrade also.
4. We, hereby, confirm to provide our full support as mentioned in Appendix-**S5 (a)** for the captioned implementation for the Endpoints supplied by us and agree to the testing pre-implementation and integration cost per Endpoint of each Make and Model, para (3), para (4) above and the SLA mentioned above, failing which the Bank may take decision to debar us for participation in future procurements or black list us.

**(Signature of the Bidder)**

**(Countersigned and stamped by**

**OEM of the Endpoint)**

## **Appendix-S5 (a)-Testing**

### I. Testing of endpoint at LAB:

The Services of an experienced and qualified resident engineers with full knowledge of technical aspects of endpoints (eg. Any functionalities, security testing, software testing, integration testing, interface testing, support UAT etc) required by the Bank during the general shift on all days except Sunday. In exceptional circumstances, services should be available for extended working hours to meet the high priority time bound requirements without any additional cost.

### II. Pre-Implementation- Integration, Testing and Pilot at Endpoints with all required functionalities:

### III. To provide one Endpoint of each model at the Bank's Test Lab as mentioned in this letter. If the said machine is already provided in the Bank's Lab alternate Hard Disk to be provided for testing.

- To Provide necessary CEN XFS device drivers along with OS.
- To Provide test cases for Hardware related errors/ unsolicited
- To provide end to end support for Solutions integration, testing at the endpoints provided, under the testing environment and successful pilot at Endpoints under the production environment.
- To share with Solution Provider Single Point Contact along with Escalation matrix for Solutions Support.
- To share the make-model-variants with Solution Provider.
- To share the following and any other details required in connection with Endpoints supplied to the Bank, with Solution Provider and to the Bank in connection with testing of all the functionalities, proper error codes, health status messages, device status messages etc at the Endpoint eg:
  - Support for Operating System
    - Windows 11 / permitted Windows 10, patches, service packs etc.
    - Changes in Operating System configuration (eg. Environment variable, parameter changes, enabling / disabling services etc)
    - End-user License Agreement (EULA)
    - Any other relevant information including Best Practices

- CEN XFS Layer:
  - XFS software compliant with CEN XFS 3.1 or higher specifications.
  - End-user license Agreement (EULA)
  - CEN XFS Layer CD to be provided.
  - Any other relevant information including Best Practices
  
- Hardware / software (both CEN XFS Compliant and Non-CEN XFS compliant)
  - Technical Specifications,
  - Documentations,
  - Drivers,
  - Terminal Diagnostic Tools/Utilities
  - Configuration / Parameter details,
  - Components,
  - Services
  - Patches, updates and upgrades
  - EMVCo/PCI certificates
  - Any other relevant information
  - Functional test cases (Positive and negative)
  - Error codes, Health Status Messages, Device status messages.
  - Provide complete details of XFS Devices
  - (Illustrative List of XFS Devices are given as under):
    - Printer and Scanners
    - Card Readers (incl. EMV Contact/Contactless)
    - Cash Dispensers
    - Personal Identification Number Keypads (PIN pads)
    - Check Readers and Scanners
    - Depository Units
    - Screen Displays (including Touch Screens)
    - Vandal Shields
    - Text Terminal Units
    - Sensors and Indicators Units
    - Vendor Dependent Mode
    - Cameras
    - Card Embossing Units
    - Alarms & Sensors
    - Cash-In Modules
    - Card Dispensers
    - Barcode Readers
    - Biometric Readers
    - Item Processing Modules
  
- Full support for CEN XFS layer required in connection with integration with Solutions.

- Support the Solution Provider with respect to any clarifications and resolution sought regarding the platform behaviour or compliance to the CEN XFS Specifications.
- Fixing of bugs / issues raised during the pre-implementation and pilot phase.
- To conduct functionality tests to avoid any operational level issues.
- Maintaining ATM-Wise version control of Solutions with granularity.
- Pilot Implementation at Endpoints of respective models/processors and its variants at live sites identified by the Bank.
- To provide sign off post completion of functionality tests with Solution Provider.
- To share all statutory or RBI compliance and security features as may be applicable on Effective Date incorporated in Endpoint-OEMs native software along with required technical details/drivers/components and test the same with the Solutions.

## APPENDIX-T

<b>Installation Certificate of ATM</b>					
Customer Name:		Customer ID:		ATM ID:	Installation Date:
<b>Bank Detail</b>					
Base Branch:			Place of Installation		
Address:			Address:		
City:			City:		
Pincode:			Pincode:		
Contact Person (Branch: Mgr/Channel Mgr)			Contact Person (Branch: Mgr/Channel Mgr)		
Contact No.:			Contact No.:		
Email ID:			Email ID:		
<b>Purchase Order / Dispatch Details</b>					
Purchase Order No.:		PO Date:		Dispatch Date:	Delivery Date:
Physical condition of machine at time of deliver:					
Damaged		<input type="checkbox"/>	Good	<input type="checkbox"/>	Partially
		<input type="checkbox"/>	Completely	<input type="checkbox"/>	Item Missing
Warranty Period:		Warranty Start Date:		Warranty Expiry Date:	
<b>Hardware Configuration</b>					
Machine Serial No.:					
Part No.	Part Description	Quantity			

**Software Configuration**

Application	Version				
MVS					
EPS					
XFS					
OS					
Native Recycler App					

**Network Configuration**

Machine IP : \_\_\_\_\_ Subnet Mask : \_\_\_\_\_ Gateway: \_\_\_\_\_  
 Remote IP : \_\_\_\_\_ Remote Port : \_\_\_\_\_

**Disposal of ATM as per e-Waste Bank's Policy**

We undertake that Machine Serial No. \_\_\_\_\_ ATM ID \_\_\_\_\_ Make \_\_\_\_\_ Model \_\_\_\_\_ have been decommissioned, lifted and shifted to our location as per RFP. We, hereby undertake that we shall dispose of the same as per the e-waste policy of the Bank.

**Certificate Compliance and submission (Attached)**

PCI-PTS Certificate (EPP,PinPads)	Yes/No
EMVCo L1 LoA, MC, Visa , Rupay Certificates (Card Readers and EMV)	Yes/No



TIS/SIS (If in Scope)			
Date when clear Site made available:	<input type="checkbox"/>	AC Installed	<input type="checkbox"/> UPS Installed
Reasons for delay if any : for dual	<input type="checkbox"/>	Hard Disk of old	Facto <input type="checkbox"/> Settings/Password
electronic lock changed		ATM/CD returned	combination
		To the branch	
Date of SIS Completion:			
We confirm that default BIOS password has been changed and ATM have been integrated with the Switch and Central MVS/EPS/Other Solutions (wherever required by Bank) and admin control taken over by Central solution.			
Following keys were handed over and received by: _____			Signature: _____
Cash out Cassette & RR Cassette key No.:		Addition Cassette Key No.:	Hood Door
key			
Safe Key Received:	<input type="checkbox"/>	Yes	<input type="checkbox"/> No
Elect. Lock Combination changed and set to dual user:	<input type="checkbox"/>	Yes	<input type="checkbox"/> No
Operation Training given to: _____			Signature: _____
Engineer Name: _____			Signature: _____
Branch Manager/ Channel Manager: _____			Signature: _____

## ANNEXURE-7

### Hard Disk & EPP Handover Format

(To be pasted on the envelope containing the Harddisk)

Last Terminal ID Assigned to machine	
Machine Type (Cash Dispenser-CD, ATM)	
Circle	
OEM Make	
OEM Serial No. of machine	
Last MS Vendor	
Date of Handover	
Tentative date of Degaussing & Disposal (6 months from Handover date)	
Last transaction date of machine (if available)	
Address of the Installed Machine	
Owner Branch code	
Owner Branch Address	
Name & PF ID of Branch Manager	
Name & PF ID of Channel Manager	

#### **DECLARATION BY OEM/MACHINE VENDOR/SCRAP VENDOR HANDING OVER HARDDISK**

*I/We give an undertaking that the integrity of the data on the Hard Disk & EPP has not been compromised and put to any misuse, causing financial or reputational loss to the Bank. The same harddisk & EPP installed in the machine has been handed over to the owner Branch.*

Name of the branch Manager or his representative accepting the Harddisk	
---	--

Signature if Branch Manager or his representative accepting the Harddisk	
--	--

#### **ACKNOWLEDGEMENT & CONFIRMATION BY OWNER BRANCH**

*I/We give an undertaking that the Harddisk & EPP has been removed from the machine in my/our presence and that same Harddisk is being preserved under our Branch's custody and that same EPP has been broken & will be disposed off as per e-waste policy.*

Name of Branch Manager or his representative accepting the Harddisk	
---	--

Signature of Branch Manager or his representative accepting the Harddisk	
--	--

## **ANNEXURE-8**

### **EXTERNAL DIGITAL SIGNAGE SOLUTION**

#### **DETAILED TECHNICAL SPECIFICATIONS OF LED EXTERNAL DIGITAL SIGNAGE SOLUTION:**

<b>S No</b>	<b>Description</b>	<b>P4 (Outdoor)</b>
1	Pixel Pitch	4mm or lesser
2	Pixel density	≥62500 Dots/Sq Mtr or higher
3	LED Lamp	SMD 2525
4	Configuration	1R1G1B
5	Size	320X160mm
6	Weight	≤0.50 Kg
7	Structure	Lamp & IC in same PCB
8	Resolution	80*40=3200 Dots
9	Max Current	<10.34A
10	Input Voltage	4.5 V
11	Power Consumption	<47W
12	Driving Mode	Constant Current
13	Brightness	>4500 cd/m2 or higher
14	Bright Variation	20-100%
15	Brightness Uniformity	>0.95
16	Horizontal Viewing angle	120-140 Deg
17	Vertical Viewing Angle	120-140 Deg
18	Best Viewing distance	>4M
19	Black Spot Ratio	<0.0003
20	Max Power Consumption	<909 W/m2
21	Operation Environment	Outdoor

22	Gray Scale	14-16 Bits (RGB Each)
23	Display Colour	≥4000 Billion
24	Refresh Frequency	3840 HZ
25	Life Span	>100000 Hours
26	IP rating	IP 65 or higher

.....

Technical Specs Server (Cloud)		COMPLIANCE (YES / NO)
1	Cloud Hosting on reputed hosting services like AWS / Azure / Google etc which can scale to support up to 10000 screens as the screen network grows without latency	
2	Robust Business Continuity & Disaster Recovery Set-up	
3	Backup: Weekly Backup ,3 Month Backup will be kept	
4	Load Balancing of Application Requests	
5	Security and network access Control	
6	99.00 % Uptime	
7	Server to be hosted in India	
8	Unlimited Displayed to be controlled	

.....

NO	CONTENT MANAGEMENT SOFTWARE FEATURES	COMPLIANCE (YES / NO)
1	The system should provide a consistent and easy to use solution with web based graphical user interface	
2	Cloud Based Solution: Dedicated Server to be hosted on the CENTRAL cloud.	

4	No content can be pushed without Bank's approval.	
5	Secured Content Download through HTTPS (443 Port) only. (No Unsecured/Unencrypted communication like FTP, Allowed	
6	Easy and intuitive interface for scheduling content on as per time, date, display, drag and drop templates, etc.	
7	Capable to Divide the screen into as many regions as required & populate images, videos, flash, etc. in these regions using drag-and-drop interface	
9	Group displays and schedule same content at once to all the displays in the group	
10	Show content in horizontal/vertical formats in any required aspect ratio and resolution.	
11	Supports content push from server & well as pull from the media player.	
12	Drag and Drop feature to create a playlist, modify the position of the files in the playlist.	
13	Content Support: Supports playback of most media formats as follows :o Video Formats: wmv, avi, mpg, mpeg, flv, mov, mp4, mkv, vob, 3gpo Image Formats: jpg, bmp, png, gif, tiff, tifo Flash Format: swfo Text: Show static as well as scrolling text (Tickers)o Adobe: pdf	
16	Over the air Software and OS updates	
17	Centrally turn ON/OFF Displays (Can be scheduled or on demand through commands)	
18	Centrally turn ON/OFF USB Ports / HDMI Ports / other Ports (Can be scheduled or on demand through commands)	
19	Smart Content Download: Schedule time to download content as per bank guidelines, distribute bandwidth equally amongst connected displays for better bandwidth utilisation, Resume downloads in case of connectivity issues	
20	Smart Delete of content: Smart delete function deletes content which is not in use from media players. However, all the deleted files will be available for redownloading.	
21	Inbuilt Media player	

22	<b>Bidder should throw dashboard notifications and send emails in case of:</b>	
A	Display Offline in working hours	
B	Media Player Offline in working hours	
C	Content Not Downloaded for more than 24 Hours	
D	Server overload	
E	Hard disk space running out	
23	<b>Default display: SBI Logo in case of content not available</b>	

\*\*\*\*\*

\*\*\*\*\*

\*\*\*\*\*

**CORRIGENDUM:**

RFP Page No.	RFP Clause No.	RFP Clause Heading	Existing Clause as per RFP XVII GEM BID NO.: GEM/2023/B/3838738 dated 17.08.2023	Revised Clause as per RFP XVII GEM BID NO.: GEM/2023/B/3838738 Corrigendum-I dated 07.09.2023.
3	5	Schedule of Events	Clarifications to queries raised at pre-bid meeting will be provided by the Bank.	On <del>01/09/2023 (date)</del> 07/09/2023
3	6	SCHEDULE OF EVENTS	Last date and time for Bid submission - 08/09/2023	Last Date: 21/09/2023 upto 03:00 PM
5	12	Earnest Money Deposit	The EMD for an amount of Rs. 2.00 crores in the form of Bank Guarantee (valid for 01 Year) from the date of bid submission date),	The EMD for an amount of Rs. 2.00 crores in the form of Bank Guarantee (valid for <del>01 Year</del> 180 days). <del>from the date of bid submission date</del> Issuance date of EMD shall be in between the Bid publish date and bid submission date and to be submitted physically to:
5	14	Schedule of Events	Performance Bank Guarantee	<del>08%</del> 05% of TCO for the entire period of the contract. Bank guarantee should be valid for 96 months from the effective date of the Contract.



12	1.2.2	Site Implementation Services (SIS)	Site Implementation Services (SIS) → Site creations / renovation (in case of existing sites) as per the Bank's Ambiance Guidelines specified in this RFP (Appendix-E). The SIS will take care of strengthening physical security by concealment of all loose wires, power, network ports, grouting / de-grouting, creation of back rooms etc., placing the machine through a false wall such that only front portion is available and the back portion with concealed wires is in the backroom, improving lighting of the room, providing RAMP facility and any other repair work alongwith statutory and mandatory requirement required at the ATM sites. Providing RAMP facility is mandatory. If RAMP is not feasible at the existing site, the ATM lobby should be shifted to a site with Ramp.	Site creations / renovation <del>Renovate</del> <b>Refurbishment/ renew</b> (in case of existing sites) as per the Bank's Ambiance Guidelines specified in this RFP (Appendix-E). The SIS will take care of strengthening physical security by concealment of all loose wires, power, network ports, grouting / de-grouting, creation of back rooms etc., placing the machine through a false wall such that only front portion is available and the back portion with concealed wires is in the backroom, improving lighting of the room, providing RAMP facility and any other repair work alongwith statutory and mandatory requirement required at the ATM sites. <b>Providing RAMP facility is mandatory. If RAMP is not feasible at the existing site, the ATM lobby should be shifted to a site with Ramp. All ATM sites should be equipped with RAMP facility as per regulatory guidelines.</b>
13	1.2.11	1.2.2 Site Implementation Services (SIS)	All existing Compliances of Guidelines / Advisory / Orders/ statutory Instructions/ SOP issued by Bank, State / District / Local Administration / GoI / IBA / RBI / MHA / NPCI etc. to be followed and complied by the successful bidders ab-initio and throughout the contract period for each machine / site. Any future guidelines/advisory by any statutory authority shall be complied without any cost to the Bank.	All existing Compliances of Guidelines / Advisory / Orders/ statutory Instructions/ SOP issued by Bank, State / District / Local Administration / GoI / IBA / RBI / MHA / NPCI etc. to be followed and complied by the successful bidders ab-initio and throughout the contract period for each machine / site. Any <b>new</b> future guidelines /advisory by any statutory / <b>regulatory</b> authority shall be complied <del>without any cost to the Bank</del> <b>with mutually agreed terms &amp; conditions and within the timeline advised by the authority.</b>
13	1.2.9	Housekeeping Services	Housekeeping Services will be optional services and Bank may take this service as per the requirements mentioned in this RFP. The additional per successful transaction rate will be derived under optional item of price bid.	1.2.9 Housekeeping Services will be optional services and Bank may take this service as per the requirements mentioned in this RFP. The additional per successful transaction rate will be derived under optional item of price bid. <b>Bank shall withdraw housekeeping services, if allotted, anytime during contract period and extension thereof by furnishing one month notice to bidder(s).</b>

18	3.16	DEFINITION S	<p>"VIP Endpoints" are those endpoints which have been installed at Prime / VIP like Airports, In-touch Branches, E-corners / e-lobby, Railway / Metro Stations, shopping malls, Market Areas, Tech Parks, Important/ main Bank Branches or any other location as identified by the Circles. Bank shall identify specific endpoints not exceeding 20% of the endpoints allocated to the respective successful bidder(s) under this RFP as 'VIP Endpoints'. The list of VIP Endpoints can be reviewed by the Bank from time to time.</p>	<p>"VIP Endpoints" are those endpoints which have been installed at Prime / VIP like Airports, In-touch Branches, E-corners / e-lobby, Railway / Metro Stations, shopping malls, Market Areas, Tech Parks, Important/ main Bank Branches or any other location as identified by the Circles. Bank shall identify specific endpoints not exceeding 20 05% of the endpoints allocated to the respective successful bidder(s) under this RFP as 'VIP Endpoints'. The list of VIP Endpoints can be reviewed by the Bank from time to time.</p>
24	5.2.2	Bidders to note that: -	<p>1) The ATM machine of a particular OEM can be supplied by either the OEM themselves OR through their authorized dealers / bidders only. In cases where the manufacturer/ OEM has submitted the bid, the bids of its authorized dealer / bidder will not be considered and EMD will be returned.</p>	<p><del>The ATM machine of a particular OEM can be supplied by either the OEM themselves OR through their authorized dealers / bidders only. In cases where the manufacturer/ OEM has submitted the bid, the bids of its authorized dealer / bidder will not be considered and EMD will be returned.</del></p>

25	5.4	5.4	<p>Bank's MVS, EPS, OMS, other software testing will be a criterion for the successful bidders. The successful bidders must deliver 2 ATM machines which are proposed for installation with 2 UPSs + Fast Charging SMF / Lithium-ion Batteries with atleast 8 hours backup (having Integrated Power Management feature) for testing at the Bank's ATM test Lab located in CBD Belapur, Navi Mumbai within 10 days (calendar days) from the issuance of LOI. The machines have to be tested successfully for OEM / Native software and Bank's MVS, EPS, OMS platform including completion of EMV L3 certification and other softwares from all the scheme (wherever necessary) within 90 days (calendar days) of delivery of machines. A penalty of Rs 10,000/- per day will be imposed on the bidders if their machines are either undelivered or not tested for MVS, EPS, OMS including completion of EMV L3 certification, other software and OEM / Native software within the prescribed timelines. The Bank however has the discretion to review the penalty.</p>	<p>Bank's MVS, EPS, OMS, other software testing will be a criterion for the successful bidders. The successful bidders must deliver <del>2</del> ATM machines which are proposed for installation with 2 UPSs + Fast Charging SMF / Lithium-ion Batteries with atleast 8 hours backup (having Integrated Power Management feature) for testing at the Bank's ATM test Lab located in CBD Belapur, Navi Mumbai <del>within 10 days (calendar days) from the issuance of LOI</del> <b>as per the timeline provided by the Bank</b>. The machines have to be tested successfully for OEM / Native software and Bank's MVS, EPS, OMS platform including completion of EMV L3 certification and other softwares from all the scheme (wherever necessary) within 90 days (calendar days) of delivery of machines. <del>A penalty of Rs 10,000/- per day will be imposed on the bidders if their machines are either undelivered or not tested</del> <b>If any delay (on account of bidder(s)) occurs beyond 15 calendar days either for delivery or successful testing of machines</b> for MVS, EPS, OMS including completion of EMV L3 certification, other software and OEM / Native software within the prescribed timelines, the Bank <del>however has the discretion to review the penalty</del> <b>reserves the right to cancel the allotted quantities and allocate such quantities to other successful bidder(s).</b></p>
----	-----	-----	---	---

25	5.5	ELIGIBILITY AND TECHNICAL CRITERIA - Note	<p>During testing of the supplied machine in the Bank's IT-Lab, if the machine is found to be incompatible with Bank's existing MVS, EPS, OMS, other software, and despite several developments / customizations / modifications by the OEMs, the machine remains incompatible, Bank reserves the right to disqualify that bidder (who supplied that machine) and assign the allocated quota (of this disqualified bidder) to other bidder(s) of this RFP whose machine is tested to be compatible. The timeframe for testing Bank's existing MVS, EPS, other softwares, and several developments / customizations / modifications by the OEMs to make their machines compatible within 90 calendar days from the date of commencement of testing by the Bank. Bank may, at its sole discretion, provide extensions to this timeframe, if deemed necessary. The penalty mentioned in clause 5.4 above shall be applicable. In case, the machines of any successful bidder found incompatible at any stage, Bank at its sole discretion may allocate its respective quotas to other successful bidder(s). Bank, at its discretion, may give the entire procurement to a single vendor whose machine is tested to be compatible, in case a single bidder situation arises.</p>	<p>During testing of the supplied machine in the Bank's IT-Lab, if the machine is found to be incompatible with Bank's existing MVS, EPS, OMS, other software, and despite several developments / customizations / modifications by the OEMs, the machine remains incompatible, Bank reserves the right to disqualify that bidder (who supplied that machine) and assign the allocated quota (of this disqualified bidder) to other bidder(s) of this RFP whose machine is tested to be compatible. The timeframe for testing Bank's existing MVS, EPS, other softwares, and several developments / customizations / modifications by the OEMs to make their machines compatible within 90 calendar days from the date of commencement of testing by the Bank. Bank may, at its sole discretion, provide extensions to this timeframe, if deemed necessary. <del>The penalty mentioned in clause 5.4 above shall be applicable.</del> In case, the machines of any successful bidder found incompatible at any stage, Bank at its sole discretion may allocate its respective quotas to other successful bidder(s). Bank, at its discretion, may give the entire procurement to a single vendor whose machine is tested to be compatible, in case a single bidder situation arises.</p>
----	-----	---	--	---

39	17.3		Shortlisted Bidders shall be willing to participate in the reverse auction process and must have a valid digital signature certificate. Such Bidders will be trained by Bank's authorized service provider for this purpose. Bidders shall also be willing to abide by the e-business rules for reverse auction framed by the Bank / Authorized service provider GeM. The details of e-business rules, processes and procedures will be provided to the short-listed Bidders.	Shortlisted Bidders shall be willing to participate in the reverse auction process and must have a valid digital signature certificate. <del>It is responsibility of the Bidder to get self-acquainted with the GeM's System &amp; Process. Such Bidders will be trained by Bank's authorized service provider for this purpose.</del> Bidders shall also be willing to abide by the e-business rules for reverse auction framed by the Bank / <del>Authorized service provider GeM. The details of e-business rules, processes and procedures will be provided to the short-listed Bidders.</del>
42	19.1.7		Definitions For the purpose of Preference to Make in India, Order 2017 (PPP-MII Order) and revision thereto:	Definitions For the purpose of <b>Public Procurement</b> Preference to Make in India, Order 2017 (PPP-MII Order) and revision thereto:
44	19.1.9	19.1.9	Purchase Preference applicability in tenders where contract is to be awarded to multiple bidders:	<b>(partially)</b> All the following scenarios are indicative in nature only for the purpose of compliance of Public procurement (preference to Make in India) order issued by DPIIT dated 16.09.2020 and Manual for Procurement of Goods (Updated June 2022). <del>and</del> Bank reserves the right to modify the distribution % basing on the emergence of any new scenario <b>as per Make in India (MII) Guidelines. The Bank will ensure the same</b> and Bank decision in this regard will be binding to bidders: -
55	24.1	PERFORMANCE BANK GUARANTEE AND BANK GUARANTEE	PERFORMANCE BANK GUARANTEE AND BANK GUARANTEE: 24.1 Performance Bank Guarantee [PBG] shall be of the amount 08% (eight%) of the Total Cost of Ownership (TCO) based on the Final reverse auction price (which shall be calculated and advised by the Bank to Selected Bidder(s)) with validity period of 96 months.	PERFORMANCE BANK GUARANTEE AND BANK GUARANTEE: 24.1 Performance Bank Guarantee [PBG] shall be of the amount <del>08% (eight%)</del> <b>5(five)%</b> of the Total Cost of Ownership (TCO) based on the Final reverse auction price (which shall be calculated and advised by the Bank to Selected Bidder(s)) with validity period of 96 months.

59	25.22	Services	The ownership of the software / firmware / operating system license and the hardware shall be that of the Bank from the date of delivery of the same to the Bank. In other words, wherever the ownership of the licenses/hardware is indicated, the name "State Bank of India" must appear to indicate that the Bank is the perpetual owner of the hardware/operating software /firmware / operating system, etc. associated with the hardware. Evidence in this regard must be submitted before the payment is released. License certificate to be provided by Vendor.	<del>The ownership of the software / firmware / operating system license and the hardware shall be that of the Bank from the date of delivery of the same to the Bank. In other words, wherever the ownership of the licenses/hardware is indicated, the name "State Bank of India" must appear to indicate that the Bank is the perpetual owner of the hardware/operating software /firmware / operating system, etc. associated with the hardware</del>
63, 74 & 76	30.2, 40.7 , 42.2 & 43.3	VALIDITY OF AGREEMENT	The Machine Site, for all practical purposes, belongs to the Bank. Service Provider will, therefore, not transfer / sell / surrender / vacate the Site or / and enter into any contract / order / agreement with any other Bank / entity for the Site without Bank's permission. The Bank will also have the first right of refusal for the Site on termination / expiry of SLA	<del>The Machine Site, for all practical purposes, belongs to the Bank.</del> —Service Provider will, <del>therefore</del> , not transfer / sell / surrender / vacate the Site or / and enter into any contract / order / agreement with any other Bank / entity for the Site without Bank's permission. The Bank will also have the first right of refusal for the Site on termination / expiry of SLA

89		Appendix-A	<p><b>Partial</b></p> <p>We have examined the above RFP with its corrigendum(a), if any, the receipt of which is hereby duly acknowledged and subsequent pre-bid clarifications / modifications / revisions, if any, furnished by the Bank and we offer to provide services / items detailed in this RFP under Total Outsourced Model (TOM). We shall abide by the terms and conditions spelt out in the RFP. We shall participate and submit the commercial Bid through online auction to be conducted by the Bank's authorized service provider Portal, on the date advised to us.</p>	<p><b>Partial:</b></p> <p>We have examined the above RFP with its corrigendum(a), if any, the receipt of which is hereby duly acknowledged and subsequent pre-bid clarifications / modifications / revisions, if any, furnished by the Bank and we offer to provide services / items detailed in this RFP under Total Outsourced Model (TOM). We shall abide by the terms and conditions spelt out in the RFP. We shall participate and submit the commercial Bid through online auction to be conducted by the <del>Bank's authorized service provider</del> GeM Portal, on the date advised to us.</p>
96	BIDDER'S ELIGIBILITY CRITERIA	5 (c)	c) Bidder will install ATMs from an OEM who has minimum installed base of 1,000 ATMs in Banks in India as on 31/03/2023 which are currently in working conditions and countersigned by the Bank.	c) Bidder will install ATMs from an OEM who has minimum installed base of 1,000 ATMs in Banks in India as on 31/03/2023 which are currently in working conditions <del>and countersigned by the Bank.</del>
96	BIDDER'S ELIGIBILITY CRITERIA	5 (c)	(c) {Duly signed Letter from the Client OEM as per <b>Appendix-S2</b> }.	Document to be submitted / document to be uploaded:(c) {Duly signed Letter from the <del>Client</del> OEM as per <b>Appendix-S2</b> }. <b>Note: - Appendix- S2 shall be from the same OEM, mentioned in Appendix S1.</b>

96	BIDDER'S ELIGIBILITY CRITERIA	6	Satisfactory Two Client references which can be Public Sector Banks (PSUs) / Private Sector Banks in India, from whom Bidder / OEM has executed similar projects for at least 500 ATMs (which are currently in working conditions) and their maintenance services, as on 31.03.2023. (Applicable to bidder(s) which are not engaged with SBI under "Per Transaction Rate Model")	<del>Satisfactory Two Client references which can be Public Sector Banks (PSUs) / Private Sector Banks in India, from whom Bidder / OEM has executed similar projects for at least 500 ATMs (which are currently in working conditions) and their maintenance services, as on 31.03.2023. (Applicable to bidder(s) which are not engaged with SBI under "Per Transaction Rate Model")</del> Bidder should specifically confirm on their letter head in this regard as per Appendix-M
122	14.1.0	Maintenance	Bidder should provide hardware, software and MIS (Keyboard, Mouse etc.) for day-to-day operations whenever required for the maintenance of machines.	<del>Bidder should provide hardware, software and MIS (Keyboard, Mouse etc.) for day-to-day operations whenever required for the maintenance of machines.</del>
155	Appendix-E SCOPE OF WORK	IV	All existing Compliances of Guidelines /Advisory/ Orders/ Instructions/SOP issued by Bank, State / District / Local Administration / GoI / IBA / RBI / MHA / NPCI or any other statutory authority etc. must be followed ab initio by successful bidders for each machine / site for all works / services under this RFP. Any future guidelines/advisory by any statutory authority shall be complied without any cost to the Bank	All existing Compliances of Guidelines /Advisory/ Orders/ Instructions/SOP issued by Bank, State / District / Local Administration / GoI / IBA / RBI / MHA / NPCI or any other statutory authority etc. must be followed ab initio by successful bidders for each machine / site for all works / services under this RFP. Any <b>new</b> future guidelines /advisory by any statutory / <b>regulatory</b> authority shall be complied <b>without any cost to the Bank with mutually agreed terms &amp; conditions and within the timeline advised by the authority.</b>



162	1 (t)	Appendix E - Scope of Work INSTALLATION OF BRAND-NEW ATMS	t) The Bank desires to install endpoints with the latest technologies. The Bidder is liable to bear the full cost of upgrading the Hardware, Software (including Operating System) for any future Operating System Patch, Operating System Upgrade, security patches, Regulatory compliances etc. which require the Hardware or Software of the endpoint to be upgraded. All Such upgrades shall be without any additional cost to the Bank for the entire contract period of 7 years and extensions thereof. Non-compliance by bidders shall attract penalty of Rs. 5,000 per day per endpoint from the end date advised by the Bank for compliance. Therefore, it is recommended that bidders install endpoints with higher configurations than the minimum specifications mentioned in this RFP	t) The Bank desires to install endpoints with the latest technologies. The Bidder is liable to bear the full cost of upgrading the Hardware, Software (including Operating System) for any future Operating System Patch, Operating System Upgrade, security patches, Regulatory compliances etc. which require the Hardware or Software of the endpoint to be upgraded. All Such upgrades shall be without any additional cost to the Bank for the entire contract period of 7 years and extensions thereof. Non-compliance by bidders shall attract penalty of Rs. <del>5,000</del> 1,000/- per day per endpoint from the end date advised by the Bank for compliance. Therefore, it is recommended that bidders install endpoints with higher configurations than the minimum specifications mentioned in this RFP
163	(w)	Installation of ATM	Vendor to replace Old / Vandalized / Non-working / Problematic machine within 30 days from the date of communication by Bank or date of incident (whichever applicable) with a new one, without any cost to the Bank. Whenever such machine is being replaced with a new one, the following should be facilitated by the Vendor: -	Vendor to replace Old / Vandalized / Non-working / Problematic machine within 30 days from the date of communication by Bank or date of incident (whichever applicable) with a new one, without any cost to the Bank. <b>Reasonable relaxation in time may be provided by Bank, where the site is sealed by Law-enforcement Agency(ies).</b> Whenever such machine is being replaced with a new one, the following should be facilitated by the Vendor: -
166	1.2 (c) & 3.2.1 n)	Electronic Journal (EJ):	c) The following penalties shall be applicable for non-performance / delayed performance of EJ related activities due to fault of the vendor(s). Banks' decision in this regard is final and binding to vendor(s). Bank shall levy a penalty of Rs. 1,000/- per instance in case of:	c) The following penalties shall be applicable for non-performance / delayed performance of EJ related activities due to fault of the vendor(s). Banks' decision in this regard is final and binding to vendor(s). Bank shall levy a penalty of Rs. <del>1,000/-</del> 500/- per <del>instance</del> <b>transaction</b> per day in case of:

166 & 177	1.3(b) & 3.4 e)	Provision of DVSS Images / Footages	Endpoint Provider shall arrange to store DVSS footages up to a period of 180 days. DVSS images backup and EJ Backup as and when required by the Bank and during preventive maintenance shall be done by the Vendor without any additional cost to the Bank.	<del>Endpoint Provider shall arrange to store DVSS footages up to a period of 180 days. DVSS images backup and EJ Backup as and when required by the Bank and during preventive maintenance shall be done by the Vendor without any additional cost to the Bank.</del> Bidder shall be responsible for availability of all cameras in working condition 24x7x365 as well as sufficient store space in HDD for storage for minimum 180 days. The responsibility of DVSS footages retrieving is of MVS vendor however, Bidder shall provide support to MVS team for retrieving of DVSS footage(s) and coordinate with them on regular basis.
167	2 c) i	Connectivity	Combination of any 2 different modes like Dual 4G / 5G SIM (Primary) with auto switch over between the 2 SIMs + VSAT (secondary) OR Broadband (primary) + Dual 4G / 5G SIM (Secondary) with auto switch over between the 2 SIMs OR any other combinations. Dual 4G / 5G SIM connectivity should be provided from two different services providers.	Combination of any 2 different modes like Dual 4G / 5G SIM (Primary) with auto switch over between the 2 SIMs + VSAT (secondary) OR Broadband (primary) + Dual 4G / 5G SIM (Secondary) with auto switch over between the 2 SIMs OR any other combinations. Dual 4G / 5G SIM connectivity should be provided from two different services providers. Dual 4G / 5G links should be on Active-Active with auto switchover to ensure seamless auto switchover amongst the two 4G / 5G links of the two separate Telcos / Service providers.
167	2 c) ii	Connectivity	Wherever (i) is not feasible and only single mode option like only VSAT is available at a location, then combination of 2 different service providers like Hughes VSAT (primary) + Tata Nelco VSAT (secondary) etc. with auto switchover facility between the two	Wherever (i) is not feasible and only single mode option like only VSAT is available at a location, then <del>combination of 2 different service providers like Hughes VSAT (primary) + Tata Nelco VSAT (secondary) etc. with auto switchover facility between the two</del> one VSAT in extended C Band shall be provided by Vendor.

168	2 f	Connectivity	The minimum bandwidth in case of VSAT last mile at each location for each ATM should be dedicated 64 Kbps with 100% concurrency (demand as on today) in extended C Band. Per ATM bandwidth requirement should match with the day-to-day requirement.	<del>The minimum bandwidth in case of VSAT last mile at each location for each ATM should be dedicated 64 Kbps with 100% concurrency (demand as on today) in extended C Band. Per ATM bandwidth requirement should match with the day-to-day requirement.</del> Minimum bandwidth in case of VSAT last mile at each location for each ATM should be dedicated 32 Kbps for upload & download respectively with 100% concurrency (demand as on today). Further, if two or more ATMs are connected with same VSAT then bandwidth would be 64 kbps using (Number of ATMs x Bandwidth) formula. However, this is applicable for VSAT connectivity only. The dedicated bandwidth should be adequately provided to carry out transactions smoothly.
167 & 177	1.3© & 3.4 f)	Provision of DVSS Images / Footages	If the vendor fails to provide the DVSS footage within 1 day when required by the Bank (within 180 days of the incident), for any reason including settlement of complaints within a reasonable time, the vendor will be liable to pay a penalty of Rs. 1,000/= per instance or the amount of penalty / loss suffered by the Bank on account of non-availability of such DVSS footage, whichever is higher.	If the vendor fails to provide the DVSS footage within 1 day when required by the Bank (within 180 days of the incident), for any reason including settlement of complaints within a reasonable time, the vendor will be liable to pay a penalty of Rs. <del>1,000/=</del> 500 per instance <del>transaction</del> or the amount of <del>award</del> / penalty / loss suffered by the Bank on account of non-availability of such DVSS footage, whichever is higher.
174	3.1(Vi)		Cheque Readers and Scanners	<del>Cheque Readers and Scanners</del>
178	4.1 a	4.1 Site Implementation Services (SIS)	Bidder shall conduct site identification exercise and offer suitable site in the vicinity of locations desired by the Bank. Vendor cannot refuse installation of Endpoints at the site desired by the Bank. In case of refusal or non-installation of Endpoint at the site desired by the Bank within 30 days of issuance of PO, a penalty equal to Rs. 5,000 per day will be charged to the vendor.	Bidder shall conduct site identification exercise and offer suitable site in the vicinity of locations desired by the Bank. Vendor cannot refuse installation of Endpoints at the site desired by the Bank. In case of refusal or non-installation of Endpoint at the site desired by the Bank within 30 days of issuance of PO, a penalty equal to <del>Rs.5,000</del> Rs.1,000/- per day will be charged to the vendor.

178	4.1 ( c ) iv	Appendix E - Scope of Work Site Implementati on Services (SIS)	Ramps must be provided at all sites. Vendor should fulfil all existing and time to time issued government / statutory guidelines in this regard. If RAMP is not feasible at the existing site, the ATM lobby should be shifted to a site with RAMP, after Bank's approval.	<del>Ramps should be provided at all sites</del> All ATM sites should be equipped with RAMP facility as per regulatory guidelines. Vendor should fulfil all existing and time to time issued government / statutory guidelines in this regard. If RAMP is not feasible at the existing site, the ATM lobby should be shifted to a site with RAMP, after Bank's approval.
179	4.1 ( c ) xiv		Selected Vendor will not install its White Label ATM(s) / ADWM(s) / White Label Mobile ATM / White Label Mobile ADWM within vicinity of 500 1,000 metre of SBI ATM / ADWM.	Selected Vendor will not install its White Label ATM(s) / ADWM(s) / White Label Mobile ATM / White Label Mobile ADWM within vicinity of <del>500</del> 1,000 metre of SBI ATM / ADWM. Bidder shall immediately inform the Bank, if White Label ATM(s) / ADWM(s) / White Label Mobile ATM / White Label Mobile ADWM is / are running within the proximity of 1,000 metre of SBI ATM / ADWM.
181	4.1.1 ix	4.1.1 Site Work Specification s – General guidelines: -	Ramps should be mandatorily available RAMPs with stainless Steel railings should be made for disabled customers to reach the ATM room easily.	<del>Ramps should be mandatorily available</del> All ATM sites should be equipped with RAMP facility as per regulatory guidelines. RAMPs with stainless Steel railings should be made for disabled customers to reach the ATM room easily.
178	4.1..b	SIS	There can be instances wherein the Bidders are assigned their old / existing sites which were under Bank's earlier MOF / TOM Agreements. At all such sites, the bidders should renovate / modify them as per the approved 3D representation of sites.	There can be instances wherein the Bidders are assigned their old / existing sites which were under Bank's earlier MOF / TOM Agreements. At all such sites, the bidders should <del>renovate / modify</del> refurbished /renew them as per the approved 3D representation of sites.

189	4.1.2	Site Work Specification	5. ENTRANCE DOOR - Providing and fixing frameless fully glazed 12mm thick toughened float glass door fixed with necessary patch fittings (Dorma / Ozone / Godrej make) including cutting, making holes, cut-outs in the glass of required shape and size to accommodate fittings and fixing the fittings in floors, soffits, jams including necessary fixtures, screws, sealant wherever required and SS cover over patch fittings.	Providing and fixing frameless fully glazed 12mm thick toughened float glass door fixed with necessary patch fittings (Dorma / Ozone / Godrej <b>or equivalent make</b> ) including cutting, making holes, cut-outs in the glass of required shape and size to accommodate fittings and fixing the fittings in floors, soffits, jams including necessary fixtures, screws, sealant wherever required and SS cover over patch fittings.
190	9	Site Implementation Services (SIS)	Should have the capability for motorized functioning of rolling up & down.	Should have the capability for <b>motorized</b> functioning of rolling up & down
190		Back Wall / False wall Panelling Ink Blue {L481-105899 / RGB: 40 0 113 / HEX: #280071 / CMYK: 97 100 0 25} of Alucobond or equivalent from Alstrong	Ink Blue {L481-105899 / RGB: 40 0 113 / HEX: #280071 / CMYK: 97 100 0 25} of Alucobond, or equivalent from Alstrong	Ink Blue {L481-105899 / RGB: 40 0 113 / HEX: #280071 / CMYK: 97 100 0 25} of Alucobond, <del>or equivalent from</del> Alstrong <b>or equivalent.</b>
197	15(a)	Appendix E - Scope of Work EARTHING	Earthing to be taken from two opposite sides for ATM machine and dual earthing to be done with two separate earth pits. Earthing of raw power circuit should not interfere with UPS neutral earthing to avoid damage to ATM software and other electronic equipment connected to UPS	Earthing to be taken <del>from two opposite sides</del> for ATM machine and <b>dual</b> earthing to be done <del>with two separate</del> earth pits. Earthing of raw power circuit should not interfere with UPS neutral earthing to avoid damage to ATM software and other electronic equipment connected to UPS

200	20 (J)	EXTERNAL DIGITAL SIGNAGE SOLUTION (EDSS)	Reputed ISI certified brands. The size of the External digital signage LED screen shall be advised by the bank for each such site. Size shall depend on the site, and it shall be minimum of 21 sq. ft.	Reputed <del>ISI</del> <b>BIS</b> certified brands. The size of the External digital signage LED screen shall be advised by the bank for each such site. Size shall depend on the site, and it shall be minimum of 21 sq. ft.
200	20 (q)	EXTERNAL DIGITAL SIGNAGE SOLUTION (EDSS)	Bidder shall attend and rectify the Break down / repair / replacement of EDSS call(s) registered by Bank / Bank's representative within 2 days. Any repair / replacement / rectification / implantation task under EDSS advised by the Bank should be completed by the bidder within 2 days of intimation. Penalty @ ₹ 500 per day from the 3 <sup>rd</sup> day onwards per non-complied call(s) will be levied	Bidder shall attend and rectify the Break down / repair / replacement of EDSS call(s) registered by Bank / Bank's representative within <b>2 4</b> days. Any repair / replacement / rectification / implantation task under EDSS advised by the Bank should be completed by the bidder within <b>2 4</b> days of intimation. Penalty @ ₹ 500 per day from the <del>3<sup>rd</sup></del> <b>5<sup>th</sup></b> day onwards per non-complied call(s) will be levied.
207	4.2 (5)	Appendix E - Scope of Work e-SURVEILLANCE SYSTEMS (eSS)	All Cameras should be IP Cameras with High Resolution (at least 3840 x 2160-pixel resolution or above) and should be able to record clear images and videos in all scenarios including dull light, no light at ATM site or the bright light from the background. While viewing the site in real time through CCTV surveillance from Command centre / dashboard / mobile app of the vendor, there should be no interruptions due to connectivity / Bandwidth related issues.	All Cameras should be IP Cameras with High Resolution (at least <del>3840 x 2160</del> <b>2688 x 1520</b> pixel resolution or above) and should be able to record clear images and videos in all scenarios including dull light, no light at ATM site or the bright light from the background. While viewing the site in real time through CCTV surveillance from Command centre / dashboard / mobile app of the vendor, there should be no interruptions due to connectivity / Bandwidth related issues.
211	28	e-SURVEILLANCE SYSTEMS (eSS)	e-Surveillance Systems (eSS) should be functional / operational 24x7x365. If any deficiency observed / found by Bank / Bank's representative, a penalty of Rs 2,000/= per instance per site shall be recovered from the Vendor.	e-Surveillance Systems (eSS) should be functional / operational 24x7x365. If any deficiency observed / found by Bank / Bank's representative, a penalty of Rs <del>2,000/=</del> <b>1,000/=</b> per instance per site shall be recovered from the Vendor.

212	30	Site Implementati on Services (SIS)	The Bank or bidder may require to: a) Shift Endpoints to new location b) Add new machine(s) at existing location c) Replace old ATM machine(s) with new one d) Renovate ATM Site In all the above mentioned cases, the bidder must Dismantle / Add / Replace / Shift / Reinstall the same / new equipment / sensors at existing / new location, as the case may be, without any cost to the Bank.	d) Renovate <del>Refurbish</del> / renew ATM Site
213	41	Appendix E - Scope of Work e- SURVEILLA NCE SYSTEMs (eSS)	An alert must be raised in case someone blocks or tampers with the cash dispenser / cash shutter of the ATM machine to manipulate the cash being dispensed by ATM machine. Whole activity should be recorded as a continuous video.	<del>An alert must be raised in case someone blocks or tampers with the cash dispenser / cash shutter of the ATM machine to manipulate the cash being dispensed by ATM machine. Whole activity should be recorded as a continuous video.</del>
214	54	Appendix E - Scope of Work e- SURVEILLA NCE SYSTEMs (eSS)	Vendor shall submit the Security Clearance Certificate of eSS from CERT-In empanelled Security Auditors annually	Vendor shall submit the Security Clearance Certificate of <b>full infrastructure of</b> eSS from CERT-In empanelled Security Auditors annually.
223	4.4.9	Housekeepin g	New	<del>Bank shall withdraw housekeeping services, if allotted, anytime during contract period and extension thereof by furnishing one month notice to bidder(s).</del>

227	4.5.2 (1)	IMPLEMENT ATION AND POST IMPLEMENT ATION SUPPORT	Vendor shall provide First Line Maintenance (FLM) including cash related faults and Second Line maintenance (SLM) for all machines, replacements and maintenance service (response and resolution), round the clock throughout the year including Saturdays, Sundays and Holidays during the terms of contract on oral/ telephonic/ email/ SMS / Mobile Application or any other mode of communication by the Bank or through its own service personnel or any service provider or any monitoring system through its own expert service resource wherever the ATMs are installed irrespective of number of physical visits at the site / endpoint and without any additional cost to the Bank. The service shall be made available by Vendor as under:	<table border="0"> <tr> <td>Category</td> <td>Resolution Time/ TAT</td> <td>Penalty</td> </tr> <tr> <td>VIP ATMs</td> <td>≤ 4 Hours: Irrespective of the population group/ category</td> <td>Rs <del>1,200</del> 500/- per endpoint per hour.</td> </tr> <tr> <td>Regular ATMs</td> <td>i. 4- 6 Hours: At Metro, Urban and Semi-urban locations</td> <td></td> </tr> <tr> <td></td> <td>ii. 6 8 Hours: At Rural locations</td> <td>Rs 4,000 200/- per endpoint per hour.</td> </tr> </table> <p>The Bank has the discretion of classifying the ATMs as VIP or Regular subject to review.</p>	Category	Resolution Time/ TAT	Penalty	VIP ATMs	≤ 4 Hours: Irrespective of the population group/ category	Rs <del>1,200</del> 500/- per endpoint per hour.	Regular ATMs	i. 4- 6 Hours: At Metro, Urban and Semi-urban locations			ii. 6 8 Hours: At Rural locations	Rs 4,000 200/- per endpoint per hour.
Category	Resolution Time/ TAT	Penalty														
VIP ATMs	≤ 4 Hours: Irrespective of the population group/ category	Rs <del>1,200</del> 500/- per endpoint per hour.														
Regular ATMs	i. 4- 6 Hours: At Metro, Urban and Semi-urban locations															
	ii. 6 8 Hours: At Rural locations	Rs 4,000 200/- per endpoint per hour.														
229	4.5.2 (2) n	IMPLEMENT ATION AND POST IMPLEMENT ATION SUPPORT	New	Bidder(s) shall arrange their own hardware, software and MIS (Keyboard, Mouse etc.) for day-to-day operation of ATMs if required by their custodians / engineers.												



233	4.5.2 (2) bb	IMPLEMENT ATION AND POST IMPLEMENT ATION SUPPORT	bb. Endpoint Provider shall arrange to store DVSS footages up to a period of 180 days. DVSS images backup and EJ Backup as and when required by the Bank and during preventive maintenance shall be done by the Vendor without any additional cost to the Bank.	p. <del>Endpoint Provider shall arrange to store DVSS footages up to a period of 180 days. DVSS images backup and EJ Backup as and when required by the Bank and during preventive maintenance shall be done by the Vendor without any additional cost to the Bank.</del> Bidder shall be responsible for availability of all cameras in working condition 24x7x365 as well as sufficient store space in HDD for storage for minimum 180 days. The responsibility of DVSS footages retrieving is of MVS vendor however, Bidder shall provide support to MVS team for retrieving of DVSS footage(s) and coordinate with them on regular basis.
238	4.5.5 I(Vi)	Appendix-E	Availability of VIP end Poin-98% Availability of Regular Endpoint 96%	vi. All machines/endpoints of the Bank will be categorized in 2 types and maintain the availability mentioned there against: Category Minimum targeted Uptime/Availability per month VIP-endpoints 98% Regular endpoints <del>96%</del> 95%
244	4.5.7	FIRST LINE MAINTENAN CE (FLM) SERVICES	iv. Site maintenance, maintaining environmental conditions and cleaning work as mentioned above in Scope of Work.	iv. Site maintenance, maintaining environmental conditions <del>etc. and cleaning work</del> as mentioned above in Scope of Work.
244	4.5.7 FIRST LINE MAINT ENANC E (FLM) SERVI CES		viii. Taking backup of camera images (of all cameras mentioned in Technical Specifications) on monthly basis on a suitable backup media and handing over the same to the controlling office.	Taking backup of camera image(s) / <del>footage(s)</del> (of all cameras mentioned in Technical Specifications) <del>as and when Software upload / reload, upgradation etc. shall be done by the bidder. on monthly basis on a suitable backup media and handing over the same to the controlling office.</del>

249	4.5.9.4 ix	Administrative Maintenance :	The CRA / CIT of the Vendor shall conduct EOD activity on ATM on daily basis and submit necessary reports.	<del>Administrative Maintenance: The CRA / CIT of the Vendor shall conduct EOD activity on ATM on daily basis and submit necessary reports. At the time of daily end of day activity, CIT shall retrieve and account for mutilated cash from the divert cassette; replenish receipt tapes, ribbons and print cartridges, if required.</del> The CRA / CIT of the Vendor shall conduct End of Day (EOD) activity on ATM on regular basis, at least on alternate day (minimum 15 days in a month) and submit necessary reports and excess cash, if any, on same day but not later than T+1 day. At the time of EOD activity, CIT shall retrieve and account for mutilated cash from the divert cassette; replenish receipt tapes, ribbons and print cartridges, if required. EOD shall be done on same day as and when Bank demands, without any additional cost to the Bank.
249	4.5.9.4 xi	New	New	CIT shall use secured cash van as per the specifications given in Annexure-1. The CRA / CIT shall ensure that cash shall always be in joint custody of two persons and single individual is not allowed to handle cash at any time. Further, security guards shall be in each vehicle for transportation of cash safely and efficiently as per RBI / MHA Guidelines.
249			New	If the Bank provides a generic tool for monitoring of movement of cash the Vendor shall integrate it with their system without any additional cost to the Bank.
250	4.5.9.4. 1	4.5.9.4.1 CASSETTE SWAP SERVICES	Cash Replenishment Services through Cassette Swap Method ab-initio: Detailed process of Cassette Swap Method shall be shared with Successful bidder later on	Cash Replenishment Services through Cassette Swap Method ab-initio <b>and without any cost to the Bank:</b> Detailed process of Cassette Swap Method shall be shared with Successful bidder later on <b>and it shall be binding to successful bidder.</b>

251	4.5.9.4. 2	Cash Replenishment / Cash Evacuation:	T+1 calendar day basis, failing which an interest @ clean overdraft rate prevalent at the material time will be recovered from the vendor along with the penalty of Rs 5000/- per instance.	The Vendor shall ensure that the entire cash handed over by the Bank is replenished in the ATMs by end of the day against which it had been provided. Reconciliation in this regard must be done on T+1 calendar day basis (where T is the replenishment day), in case of vaulting facility is extended to vendor and/ or on T+0 basis, in case no vaulting facility is extended to Vendor. In any case the cash must reconcile by depositing in Branches on T+1 calendar day basis, failing which an interest @ clean overdraft rate prevalent at the material time will be recovered from the vendor <del>along with the penalty of Rs 5000/- per instance.</del>
254	4.5.9.4. 4	CURRENCY VAULTING SERVICES: -	As daily vaulting is permitted, the vendors to ensure compliance on the following: -a) Cash outs should be zero. All efforts will be made by Bank to provide the indented cash 1 day prior with overnight vaulting provision in the required denominations. b) VIP / High-Hit ATMs to be replenished twice / thrice a day, if required, and without any cost to the bankc) In no case, idle cash should be present in ATMs. There should not be over-indenting of cash.d) Vaults will be subjected to audits by the RBI/ Bank / Auditors whenever required. e) Sufficient insurance has to be ensured and a copy of the policy to be provided to LHOs.	<del>b) VIP / High-Hit ATMs to be replenished twice / thrice a day, if required, and without any cost to the bank</del>

254	4.5.9.4.5	Daily EOD	Vendor shall arrange for daily EOD and prepare daily End-of-Day (EOD) activity report [ATM ID wise] as per prescribed format mentioned in Annexure-4 to this Cash Appendix, supervisory counters and admin slips under the signature of Vendor / their representative/s performing cash replenishment and submit to Bank same day but not later than next day. Vendor shall provide Cash Balance Report (CBR), Vault Closing Balance Report (VCB) and Overage & Shortage Report (OSR) as per format mentioned in Annexure-5 to Bank designated linked branch daily via e-mail.	Vendor shall arrange for <del>daily EOD</del> as per Scope of Services under Cash Appendix of this RFP and prepare daily End-of-Day (EOD) activity report [ATM ID wise] as per prescribed format mentioned in Annexure-4 to this Cash Appendix, supervisory counters and admin slips under the signature of Vendor / their representative/s performing cash replenishment and submit to Bank same day but not later than next day. Vendor shall provide Cash Balance Report (CBR), Vault Closing Balance Report (VCB) and Overage & Shortage Report (OSR) as per format mentioned in Annexure-5 to Bank designated linked branch daily via e-mail.
255	iv.	Cash out Exclusions:	Vendor shall not be responsible for cash outs and related downtime of endpoint, if it arises due to following reasons:.....	<del>Quantum of cash not received as per indents raised by Vendor. However, bank has discretion to provide lesser quantum of cash than the indents raised by vendor considering the dispensation pattern of Endpoint and the cash available with the Bank Branch.</del> Quantum of cash not received as per indents raised by Vendor based on the dispensation pattern of Endpoint(s) and / or as per the envisaged Factor of safety (FoS) mentioned in this RFP.
256	4.5.9.4.6 viii	USE OF ONE TIME COMBINATI ON (OTC) FOR ENDPOINT VAULTS: -	CIT shall use secured cash van as per the specifications given in Annexure-1. The CRA / CIT shall ensure that cash shall always be in joint custody of two persons and single individual is not allowed to handle cash at any time. Further, security guards shall be in each vehicle for transportation of cash safely and efficiently as per RBI / MHA Guidelines.	<del>CIT shall use secured cash van as per the specifications given in Annexure-1. The CRA / CIT shall ensure that cash shall always be in joint custody of two persons and single individual is not allowed to handle cash at any time. Further, security guards shall be in each vehicle for transportation of cash safely and efficiently as per RBI / MHA Guidelines.</del>

256	4.5.9.4.6 USE OF ONE TIME COMBINATION (OTC) FOR ENDP OINT VAULTS: -		ix. If the Bank provides a generic tool for monitoring of movement of cash the Vendor shall integrate it with their system without any additional cost to the Bank.	<del>ix. If the Bank provides a generic tool for monitoring of movement of cash the Vendor shall integrate it with their system without any additional cost to the Bank.</del>
287	Appendix-F	: INDICATIVE COMMERCIAL PRICE BID FORMATs Optional Services	External Digital Signage Solutions (EDSS) F = Financial E = 3% of A Non-Financial F = 3% of B	External Digital Signage Solutions (EDSS) F = Financial E = 3 5% of A Non-Financial F = 3 5% of B
293	Appendix H1	EMD Bank Guarantee	Partially 12 months	Partially 180 days
301	1.8	Appendix-I - General penalties & Incentives	If the machine is not cash-live within 30 days at metro areas and 40 days at Rural / semi-Urban / Urban areas from the date of Purchase order placed by respective circles, and the reason for delay is not attributable to the Bank, the vendor will be liable to pay a penalty of Rs. 5,000/- per machine per day from	If the machine is not cash-live within 30 days at metro areas and 40 days at Rural / semi-Urban / Urban areas from the date of Purchase order placed by respective circles, and the reason for delay is not attributable to the Bank, the vendor will be liable to pay a penalty of <del>Rs. 5,000/-</del> ₹1,000/- per machine per day from 31 <sup>st</sup> day for metro and urban / 41 <sup>st</sup> day for other areas, which will be realized/recovered from the vendor from their invoices. In case of any delay due to Bank dependency, the vendor has to advise the same in writing along with the necessary proof mentioning the cause of delay.

302	2.7	PENALTIES & INCENTIVES	The endpoints have been classified into two different categories – VIP endpoints and Regular endpoints: VIP endpoints - Minimum targeted uptime 98% Regular endpoints - Minimum targeted uptime 96%	The endpoints have been classified into two different categories – VIP endpoints and Regular endpoints: VIP endpoints - Minimum targeted uptime 98% Regular endpoints - Minimum targeted uptime <del>96%</del> <b>95%</b>
302	2.8.	Penalty for not maintaining the target availability:	2.8.3. VIP endpointsAvailability Penalty Amount95% to less than 98% 5% of Charges Payable92% to less than 95% 10% of Charges PayableLess than 92% 25% of Charges Payable2.8.4. Regular endpoints:Availability Penalty Amount93% to less than 96% 5% of Charges Payable90 % to less than 93% 10% of Charges PayableLess than 90% 25% of Charges Payable	2.8.3. VIP endpointsAvailability Penalty Amount95% to less than 98% 5% of Charges Payable92% to less than 95% 10% of Charges PayableLess than 92% 25% of Charges Payable2.8.4. Regular endpoints:Availability Penalty Amount93% to less than <del>96%</del> <b>95%</b> 5% of Charges Payable90 % to less than 93% 10% of Charges PayableLess than 90% 25% of Charges Payable
304	3. MANAGED SERVICES:	3. MANAGED SERVICES:	VIP ATMs - 2 Hours: Irrespective of the population group / category - Rs. 1200/- per endpoint per hour. Regular ATMs - i. 4 Hours: At Metro, Urban and Semi-urban locations ii. 6 Hours: At Rural locations - Rs. 1000/- per endpoint per hour.	VIP ATM- <del>2</del> <b>4</b> Hours: Irrespective of the population group/ category. <del>Rs. 1,200/-</del> <b>₹500/-</b> per endpoint per hour. Regular ATMs i. <del>4</del> <b>6</b> Hours: At Metro, Urban, and Semi-urban locations, ii. <del>6</del> <b>8</b> Hours: At Rural locations <del>Rs.1000/-</del> <b>₹200/-</b> per endpoint per hour.

305	3.2.3 MANA GED SERVI CES:	Housekeepin g	3.2.3. Penalty shall be levied if ATM/ site / allied equipment(s) is not maintained clean and in proper condition. The penalty shall be levied for each instance reported by Channel Manager / Bank official / e-Surveillance / any customer / social media / any complaint etc.	Category VIP ATMs Regular ATMs	Penalty Rs.3,000/- <del>₹750/-</del> per site per instance Rs.2,000/- <del>₹500/-</del> per site per instance
305	3.2.5 MANA GED SERVI CES:	Housekeepin g	3.2.5. An additional penalty of Rs. 5,000/- per site per month shall be levied if Vendor receives more than 2 recorded complaints from the Bank for that particular site in the particular month, pertaining to unsatisfactory maintenance, upkeep and general cleaning of the sites.	3.2.5. An additional penalty of Rs. 5,000/- <del>₹1,000/-</del> per site per month shall be levied if Vendor receives more than 2 recorded complaints from the Bank for that particular site in the particular month, pertaining to unsatisfactory maintenance, upkeep and general cleaning of the sites. It will be the responsibility of the vendor to submit a daily report to the concerned Circles and the Channel Managers of the respective endpoint.	
306	3.3.3	consumable s:	3.3.3. Penalty @ Rs.1000/- per incident shall be levied if consumables are not made available within four hour from the time information available in Online Monitoring Tools or complaint lodged by Bank official at the portal and/ or advised by Channel Manager or by the Bank official in this regard. The consumables required are to be replaced by the vendor at the respective machines.	Penalty @ Rs.1000/- <del>₹100/-</del> per incident shall be levied if consumables are not made available within four hour from the time information available in Online Monitoring Tools or complaint lodged by Bank official at the portal and/ or advised by Channel Manager or by the Bank official in this regard. The consumables required are to be replaced by the vendor at the respective machines.	
306	3.4.1.6.	Penalty for not maintaining target FoS:	Excess cash = opening balance + cash replenished - Ideal cash; where Ideal cash = Average Cash dispensed * Target FoS	Excess cash = <del>opening balance + cash replenished</del> closing balance - Ideal cash; where Ideal cash = <del>Average Cash dispensed *</del> Average Daily withdrawal of previous month x Target FoS	

307	3.4.1.1 2	FOS	New	Circles shall decide to provide 50% waiver in FOS penalty (i.e., interest on excess cash) with respect to Geographical areas like hilly terrain, which are difficult areas such as part of Arunachal Pradesh, Mizoram, Nagaland, Tripura, Manipur, Meghalaya, Assam, Jammu & Kashmir, Sikkim, Himachal Pradesh, Uttarakhand and for the ATMs situated at another Centre (other than the district headquarters) and ATMs located at more than 40 KMs away from the cash link Branches.
-----	--------------	-----	-----	---



307 &308	3.4.2	Cash Out	<p>In case the cash out extends beyond 3 hours and up to 10 hours, then penalty shall be Rs.2,500/- (for First three hours) + Rs. 2,500 for each hour or part thereof (excluding first three hours).</p>	<p><del>a) Penalty shall be Rs. 2,500/- per incidence per endpoint for first 3 hours.</del></p> <p><del>b) In case the cash out extends beyond 3 hours and upto 10 hours, then penalty shall be Rs.2,500/- (for First three hours) + Rs. 2,500 for each hour or part thereof (excluding first three hours).</del></p> <p><del>c) if cash out continues beyond 10 hours, penalty shall be b) above (for first 10 hours) + Rs 5,000/- for each block of 4 hours or part thereof (excluding first 10 hours).</del></p> <p><del>Example: If a cash out incident is closed within 3 hours, the penalty shall be Rs. 2,500/- only. However, if it is closed in 30 hours, the penalty would be Rs. 45,000/- (Rs. 2500/- for first 03 hours + Rs.17500/- for next 07 hours (2500x7) + Rs. 25000/- (5000/- X 5 for next 20 hours)</del></p> <p>a) Cash-out at any ATM of more than five (05) hours in a month will attract a flat penalty of ₹ 5,000/- per ATM.</p> <p>b) Apart from above a), in case the cash out extends beyond five (05) hours and upto 10 hours in a month, then penalty shall be Rs. 5,000/- (for First five hours) + ₹1,500/- for each hour (excluding first five hours in a month).</p> <p>c) if cash out continues beyond 10 hours in a month, penalty shall be for first 10 hours (as above, b)) + @ ₹500/- for each hour (excluding first 10 hours).</p> <p>Example: If Cash-out at any ATM of more than five (05) hours in a month, will attract a penalty of ₹ 5,000/- per ATM. However, if Cash-out at any ATM is 20 hours</p>
-------------	-------	----------	--	---

				<p>in a month, the penalty would be ₹17,500/- (Rs. 5000/- for first 05 hours + ₹7,500/- for next 05 hours (₹1,500 x 5) + ₹5000/- (₹500 X 10 for next 10 hours in a month).</p> <p>d) Bank shall levy penalty of Rs 2,500/- per incident, if reject bins not cleared within 4 hours.</p>
--	--	--	--	---

308	3.4.3	Cash Reconciliation	At the time of EOD (end of day) activity CRA will reconcile physical cash in the cassettes of endpoints and in the purge bin (reject bin) with the ADMIN balance (end cash shown denomination wise in ADMIN slip). Delay in EOD activity of endpoints results in reconciliation arrears. Therefore, for delay in reconciliation, vendor shall pay Rs.100/- per day per endpoint for the delayed period. However, Bank may at its discretion consider exceptional cases where EOD is not feasible daily due to genuine reason. Further any Loss occurred / penalty paid on account of delay in settling of dispute transactions on account of non-submission of EOD report will be recovered from Vendor.	At the time of EOD (end of day) activity CRA will reconcile physical cash in the cassettes of endpoints and in the purge bin (reject bin) with the ADMIN balance (end cash shown denomination wise in ADMIN slip). Delay in EOD activity of endpoints results in reconciliation arrears. Therefore, for delay in reconciliation, vendor shall pay Rs.100/- per day per endpoint for the delayed period. <del>However, Bank may at its discretion consider exceptional cases where EOD is not feasible daily due to genuine reason.</del> Further any Loss occurred / penalty paid on account of delay in settling of dispute transactions on account of non-submission of EOD report will be recovered from Vendor.
309	3.4.3	Cash Reconciliation	The Vendor shall ensure that the entire cash handed over by the Bank is replenished in the ATMs by end of the day against which it had been provided. Reconciliation in this regard must be done on T+ 1 (where T is the replenishment day) basis in case of vaulting facility is extended to vendor and / or on T+0 in case no vaulting facility is extended to Vendor. In any case the cash must reconcile either by replenishment in ATMs or depositing in Branches on T+1 basis, failing which an interest @ clean overdraft rate prevalent at the material time will be recovered from the vendor along with the penalty of Rs. 5,000/- per instance.	The Vendor shall ensure that the entire cash handed over by the Bank is replenished in the ATMs by end of the day against which it had been provided. Reconciliation in this regard must be done on T+ 1 (where T is the replenishment day) basis in case of vaulting facility is extended to vendor and / or on T+0 in case no vaulting facility is extended to Vendor. In any case the cash must reconcile either by replenishment in ATMs or depositing in Branches on T+1 basis, failing which an interest @ clean overdraft rate prevalent at the material time will be recovered from the vendor <del>along with the penalty of Rs. 5,000/- per instance.</del>

313	5.8.	Penalty for EDSS:	5.8.1. Bidder shall attend and rectify the break down / repair / replacement of EDSS call(s) registered by Bank / Bank's representative within 2 days. Any repair / replacement / rectification / implantation task under EDSS advised by the Bank should be completed by the bidder within 2 days of intimation. Penalty @ ₹ 500 per day from the 3rd day onwards per non-complied call(s) will be levied.	Bidder shall attend and rectify the break down / repair / replacement of EDSS call(s) registered by Bank / Bank's representative within <del>2</del> 4 days. Any repair / replacement / rectification / implantation task under EDSS advised by the Bank should be completed by the bidder within <del>2</del> 4 days of intimation. Penalty @ ₹ 500 per day from the <del>3rd</del> 5th day onwards per non-complied call(s) will be levied.
313	5.8.3	Ess Penalty	5.8.3. e-Surveillance Systems (eSS) should be functional / operational 24x7x365. If any deficiency observed / found by Bank / Bank's representative, a penalty of Rs 2,000/= per instance per site shall be recovered from the Vendor.	5.8.3. e-Surveillance Systems (eSS) should be functional / operational 24x7x365. If any deficiency observed / found by Bank / Bank's representative, a penalty of <del>Rs 2,000/=</del> ₹1,000 per instance per site shall be recovered from the Vendor.

313	Penalty 6.1	6. TESTING & MACHINE TECHNICAL ISSUES:	Bank's MVS, EPS, OMS, other software testing will be a criterion for the successful bidders. The successful bidders must deliver 2 ATM machines which are proposed for installation with 2 UPSs + Fast Charging SMF / Lithium-ion Batteries with atleast 8 hours backup (having Integrated Power Management feature) for testing at the Bank's ATM test Lab located in CBD Belapur, Navi Mumbai within 10 days (calendar days) from the issuance of LOI . The machines have to be tested successfully for OEM / Native software and Bank's MVS, EPS, OMS platform including completion of EMV L3 certification and other softwares from all the scheme (wherever necessary) within 90 days (calendar days) of delivery of machines. A penalty of Rs 10,000/- per day will be imposed on the bidders if their machines are either undelivered or not tested for MVS, EPS, OMS including completion of EMV L3 certification, other software and OEM / Native software within the prescribed timelines, the Bank however has the discretion to review the penalty.	Bank's MVS, EPS, OMS, other software testing will be a criterion for the successful bidders. The successful bidders must deliver <b>2 ATM machines</b> which are proposed for installation with <b>2 UPSs + Fast Charging SMF / Lithium-ion Batteries</b> with atleast 8 hours backup (having Integrated Power Management feature) for testing at the Bank's ATM test Lab located in CBD Belapur, Navi Mumbai <b>within 10 days (calendar days) from the issuance of LOI as per the timeline provided by the Bank.</b> The machines have to be tested successfully for OEM / Native software and Bank's MVS, EPS, OMS platform including completion of EMV L3 certification and other softwares from all the scheme (wherever necessary) within 90 days (calendar days) of delivery of machines. <b>A penalty of Rs 10,000/- per day will be imposed on the bidders if their machines are either undelivered or not tested If any delay (on account of bidder(s)) occurs beyond 15 calendar days either for delivery or successful testing of machines</b> for MVS, EPS, OMS including completion of EMV L3 certification, other software and OEM / Native software within the prescribed timelines, the Bank <b>however has the discretion to review the penalty reserves the right to cancel the allotted quantities and allocate such quantities to other successful bidder(s).</b>
318	14	Ess Penalty	New	<b>If any deficiency observed / found by Bank / Bank's representative, a penalty of ₹1,000/- per instance per site shall be recovered from the Vendor.</b>
323	2.1.7	Definition: TOM	Any future guidelines / advisory by any statutory authority shall be complied without any cost to the Bank	Any <b>new</b> future guidelines /advisory by any statutory / <b>regulatory</b> authority shall be complied <del>without any cost to the Bank</del> <b>with mutually agreed terms &amp; conditions and within the timeline advised by the authority.</b>
373	Appendix M		Format	Deleted

401	Appendix S1 & S2		Foarmat	Ammended
417	Annexure 8	EDSS	New	IP Rating: IP65 or Higher

**REPLY TO THE PRE-BID QUERIES:**

RFP Page No.	RFP Clause No.	RFP Clause Heading	Existing Clause	Query / Suggestions	BANK REPLY
2	Bid Document	RA Qualification Rule	H1-Highest Priced Bid Elimination	Request Bank to exclude the Elimination of H1 vendor clause	Terms & Conditions applicable as per RFP.
3	6	Last date and time for Bid submission	Last Date: 08/09/2023 upto 03:00 PM	We request bank to extend the Bid submission date at-least for 15 days working days from the Pre-bid response date	<b>CORRIGENDUM:</b> Last Date: 21/09/2023 upto 03:00 PM
3	6	SCHEDULE OF EVENTS	Last date and time for Bid submission - 08/09/2023	Considering the large number of documents as part of bid submission, we need enough time to arrange these. We request Bank to provide minimum time of 21 working days from date of publishing final corrigendum for the submission of bid.	<b>CORRIGENDUM:</b> Last Date: 21/09/2023 upto 03:00 PM
3	6	Schedule of Events	Last date and time for Bid submission - Last Date: 08/09/2023 upto 03:00 PM	It is highly challenging to prepare/ collate all the documents within one week & submit the same in GeM portal. Request Bank atleast provide 2 weeks i.e., 15th September'23 for final bid submission from the date of prebid response from Bank	<b>CORRIGENDUM:</b> Last Date: 21/09/2023 upto 03:00 PM

3	16	SCHEDULE OF EVENTS	The bid documents and commercial bid shall be submitted online on GeM portal only as per this RFP document and as per the provisions and terms & conditions of GeM portal.	Request Bank to clarify which are the documents to be submitted in hardcopy	Terms & Conditions applicable as per RFP. Clarification: Vendor shall also submit Hard Copy before the given time.
3	3.c	SCHEDULE OF EVENTS	Non reply to any of the queries raised by the vendors shall NOT be considered as acceptance of the query / issue by the Bank.	Non reply to query of the vendor should be treated as deemed acceptance by the bank. Bank should specifically respond to the query quoting relevant provisions/rules/reasoning. Bank should give a definitive response to each of the queries.	Terms & Conditions applicable as per RFP.
3	Schedule of Events	Pre - bid Meeting at (venue)	State Bank of India, Anytime Channels Dept., 3rd Floor, World Trade Centre, "Arcade", Cuff parade, Mumbai – 400 005 or through Online Meeting. On 28/08/2023 @ 11:00 AM	Requesting the Bank to consider the Pre-bidding in person for better coordination	Terms & Conditions applicable as per RFP.. Clarification: Already Conducted Pre-Bid meeting in Person.
3	Schedule of Events	Schedule of Events	Date and Time of opening of Technical Bids	Requesting the Bank to consider the min. 3 weeks from the final Pre-bid response from the Bank, for Bid submission	<b>CORRIGENDUM:</b> <b>Last Date: 21/09/2023 upto 03:00 PM</b>



5	12	EMD	The EMD for an amount of Rs. 2.00 crores in the form of Bank Guarantee (valid for 01 Year) from the date of bid submission date),	We request bank to change EMD validity period for 180 days. 1 years is very long period.	<b>CORRIGENDUM:</b> The EMD for an amount of Rs. 2.00 crores in the form of Bank Guarantee (valid for <del>01 Year</del> <b>180 days</b> ). <del>from the date of bid submission date</del> <b>Issuance date of EMD shall be in between the Bid publish date and bid submission date and</b> to be submitted physically to:
5	12	SCHEDULE OF EVENTS	The EMD for an amount of Rs. 2.00 crores in the form of Bank Guarantee (valid for 01 Year) from the date of bid submission date), to be submitted physically	Request Bank to modify this clause (from the date of bid submission) as the BG is issued by BG Issuing Bank prior to bid submission date. We are also requesting the Bank to consider Insurance Surety Bonds instead of BG as per notified guidelines in Procurement Manual.  Please share the Bank details for issuance of BG / EMD / Surety Bond.	<b>CORRIGENDUM:</b> The EMD for an amount of Rs. 2.00 crores in the form of Bank Guarantee (valid for <del>01 Year</del> <b>180 days</b> ). <del>from the date of bid submission date</del> <b>Issuance date of EMD shall be in between the Bid publish date and bid submission date and</b> to be submitted physically to:

5	14	Bank Guarantee (BG)	Bank Guarantee [on the lines of Appendix-H], issued by Scheduled Commercial Bank in India, other than State Bank of India, drawn in favour of State Bank of India payable at Mumbai. Bank guarantee should be valid for 96 months from the effective date of the Contract. In case Bank extends the contract further PBG may be provided as per the percentage specified in original contract.	Requesting the Bank to consider the overall Performance Bank Guarantee (PBG) Tenure as 5 Years (including claim period), considering most of the bank's issue PBG for less than equal to 5 Years only and refrain from issuing PBG beyond 5 years. Later after completion of 2 years, we will issue amended PBG extending the tenure by 2 years,	Terms & Conditions applicable as per RFP.
5	Schedule of Events	Schedule of Events	08 % of TCO for the entire period of the contract. Bank guarantee should be valid for 96 months from the effective date of the Contract.	Request Bank to consider BG renewal at 3% on Annual TCO for each year	<b>CORRIGENDUM:</b> <del>08%</del> <b>05%</b> of TCO for the entire period of the contract. Bank guarantee should be valid for 96 months from the effective date of the Contract.

12	1.2.1	Invitation to Bid	1.2.1 Installation of all Brand New 13,500 ATMs as per the Technical and other specifications mentioned in the later part of this RFP (Appendix-C1 to C4) including all Physical and Digital Security Guidelines.	We request for bank clarification on "Are there any additional guidelines other than those mentioned in Appendix - C1 to C4".	Terms & Conditions applicable as per RFP. Clarification: Please refer to Physical and Digital Security Guidelines mentioned elsewhere in this RFP.
----	-------	-------------------	---	---	--

12	1.2.2	INVITATION TO BID	<p>Site Implementation Services (SIS) → Site creations / renovation (in case of existing sites) as per the Bank's Ambiance Guidelines specified in this RFP (Appendix-E). The SIS will take care of strengthening physical security by concealment of all loose wires, power, network ports, grouting / de-grouting, creation of back rooms etc., placing the machine through a false wall such that only front portion is available and the back portion with concealed wires is in the backroom, improving lighting of the room, providing RAMP facility and any other repair work along with statutory and mandatory requirement required at the ATM sites. Providing RAMP facility is mandatory.</p>	<p>Require clarity for the existing offsite, without backroom.</p>	<p>Terms &amp; Conditions applicable as per RFP. Clarification: Back Room is mandatory.</p>
----	-------	-------------------	--	--	---

		<p>If RAMP is not feasible at the existing site, the ATM lobby should be shifted to a site with Ramp.</p>		
--	--	---	--	--

12	1.2.2	RAMP Facility	If RAMP is not feasible then ATM lobby should be shifted to site with RAMP.	Will Bank provide the exception if the site is prominent and Ramp construction is not technically feasible.	<p><b>CORRIGENDUM:</b> providing RAMP facility and any other repair work alongwith statutory and mandatory requirement required at the ATM sites. <del>Providing RAMP facility is mandatory. If RAMP is not feasible at the existing site, the ATM lobby should be shifted to a site with Ramp.</del></p> <p>All ATM sites should be equipped with RAMP facility as per regulatory guidelines.</p>
----	-------	---------------	---	---	--

12	1.2.2	SIS	<p>providing RAMP facility and any other repair work alongwith statutory and mandatory requirement required at the ATM sites. Providing RAMP facility is mandatory. If RAMP is not feasible at the existing site, the ATM lobby should be shifted to a site with Ramp.</p>	<p>Providing RAMP mandatory at 100% Sites will not be possible due to space . Suggest to keep it in some % of total sites. For any feasible RAMP The maximum allowable slope in any new construction is 1:12 with a maximum rise of 30" (76.2 cm) without a landing. A ramp with a slope between 1:12 and 1:16 can have a maximum horizontal length of 30' (9.14 m) without a landing. A ramp with a slope between 1:16 and 1:20 can have a horizontal run up to 40' (12.19 m) before requiring a landing.</p> <p>Ramp Widths :</p> <p>ADA accessible ramps must maintain a minimum clear width of 36" (91.4 cm) at all times. The cross slope along the width of any ramp must be less than 1:50 or &lt;2%. The 36" (91.4 cm) clear width must be maintained between all including handrails.</p>	<p><b>CORRIGENDUM:</b> providing RAMP facility and any other repair work alongwith statutory and mandatory requirement required at the ATM sites. <del>Providing RAMP facility is mandatory. If RAMP is not feasible at the existing site, the ATM lobby should be shifted to a site with Ramp.</del> <b>All ATM sites should be equipped with RAMP facility as per regulatory guidelines.</b></p>
----	-------	-----	--	--	--

12	1.2.2	SIS	<p>Site creations / renovation (in case of existing sites) as per the Bank's Ambiance Guidelines specified in this RFP (Appendix-E).</p>	<p>We request bank to clarify renovation word for existing sites. This is new deployment so request bank to modify the clause to include that the site has to be rebuilt from grounds up.</p> <p>Renovation means refurbishment where the existing vendors may have advantage where instead of putting new equipment they may just repair and clean the site and make the site functional. For new vendors, the entire cost of the site build needs to be considered while for existing bidders, they may consider only a fraction of the new site build making might will give them the cost advantage against new BLA vendors.</p>	<p><b>CORRIGENDUM:</b>  Site creations / <del>renovation</del> <b>Refurbishment/ renew</b> (in case of existing sites) as per the Bank's Ambiance Guidelines specified in this RFP (Appendix-E).</p>
----	-------	-----	--	--	--



12	1.2.2	Site Implementation Services (SIS)	<p>Site Implementation Services (SIS) → Site creations / renovation (in case of existing sites) as per the Bank's Ambiance Guidelines specified in this RFP (Appendix-E). The SIS will take care of strengthening physical security by concealment of all loose wires, power, network ports, grouting / de-grouting, creation of back rooms etc., placing the machine through a false wall such that only front portion is available and the back portion with concealed wires is in the backroom, improving lighting of the room, providing RAMP facility and any other repair work alongwith statutory and mandatory requirement required at the ATM sites. Providing RAMP facility is mandatory.</p>	<p>If RAMP is not feasible at the existing site, the ATM lobby should be shifted to a site with Ramp. Bank to bear such a cost of shifting of existing to new site</p>	<p><b>CORRIGENDUM:</b> Site creations / <del>renovation</del> <b>Refurbishment/ renew</b> (in case of existing sites) as per the Bank's Ambiance Guidelines specified in this RFP (Appendix-E). The SIS will take care of strengthening physical security by concealment of all loose wires, power, network ports, grouting / de-grouting, creation of back rooms etc., placing the machine through a false wall such that only front portion is available and the back portion with concealed wires is in the backroom, improving lighting of the room, providing RAMP facility and any other repair work alongwith statutory and mandatory requirement required at the ATM sites. <del>Providing RAMP facility is mandatory. If RAMP is not feasible at the existing site, the ATM lobby should be shifted to a site with Ramp.</del> <b>All ATM sites should be equipped with RAMP facility as per regulatory guidelines.</b></p>
----	-------	------------------------------------	---	--	--

If RAMP is not feasible at the existing site, the ATM lobby should be shifted to a site with Ramp.

12	1.2.2 Site Implementati on Services (SIS) →		<p>Site creations / renovation (in case of existing sites) as per the Bank’s Ambiance Guidelines specified in this RFP (Appendix-E). The SIS will take care of strengthening physical security by concealment of all loose wires, power, network ports, grouting / de-grouting, creation of back rooms etc., placing the machine through a false wall such that only front portion is available and the back portion with concealed wires is in the backroom, improving lighting of the room, providing RAMP facility and any other repair work alongwith statutory and mandatory requirement required at the ATM sites. Providing RAMP facility is mandatory. If RAMP is not feasible at the existing site, the</p>	<p>For Higher Txns the ATMs are supposed to be in Main market areas Where shops are easily approachable from Footpath / Road . The space outside mostly under municipal control and creating a ramp with 1: 12 or 1:6 ratio as per Ramp guidelines will not be feasible at most of the high potential sites . Shifting to not so crowded and open locations will have a direct negative impact on transactions .</p>	<p><b>CORRIGENDUM:</b>  Site creations / <del>renovation</del> <b>Refurbishment/ renew</b> (in case of existing sites) as per the Bank’s Ambiance Guidelines specified in this RFP (Appendix-E). The SIS will take care of strengthening physical security by concealment of all loose wires, power, network ports, grouting / de-grouting, creation of back rooms etc., placing the machine through a false wall such that only front portion is available and the back portion with concealed wires is in the backroom, improving lighting of the room, providing RAMP facility and any other repair work alongwith statutory and mandatory requirement required at the ATM sites. <del>Providing RAMP facility is mandatory. If RAMP is not feasible at the existing site, the ATM lobby should be shifted to a site with Ramp.</del> <b>All ATM sites should be equipped with RAMP facility as per regulatory guidelines.</b></p>
----	---	--	--	--	---

		ATM lobby should be shifted to a site with Ramp.		
--	--	--	--	--

13	1.2.10	Caretaker Services	Caretaker Services at sites wherever required by the Bank, State / District / Local Administration / GoI / IBA / RBI / MHA / NPCI etc.	(a) What type of Caretaker services are required? Specifications are not mentioned. Request bank for clarification	Terms & Conditions applicable as per RFP. Clarification: It is as per the direction by the authorities as mentioned in this RFP.
13	1.2.10	INVITATION TO BID	Caretaker Services at sites wherever required by the Bank, State / District / Local Administration / GoI / IBA / RBI / MHA / NPCI etc.	Would request the Bank to specify a capping on % of sites that will be considered for Caretaker Services. Since, considering it on overall sites would inflate the pricing	Terms & Conditions applicable as per RFP. It is as and when directed by the authorities as mentioned in this RFP.
13	1.2.11	1.2.2 Site Implementation Services (SIS)	All existing Compliances of Guidelines / Advisory / Orders/ statutory Instructions/ SOP issued by Bank, State / District / Local Administration / GoI / IBA / RBI / MHA / NPCI etc. to be followed and complied by the successful bidders ab-initio and throughout the contract period for each machine / site. Any future guidelines/advisory by any statutory authority shall be	Regulatory changes are not in any one's control, therefore, future guidelines/ advisory and compliance thereof can only be handled through mutual agreement at the time when such guidelines come into force.	<b>CORRIGENDUM:</b> All existing Compliances of Guidelines / Advisory / Orders/ statutory Instructions/ SOP issued by Bank, State / District / Local Administration / GoI / IBA / RBI / MHA / NPCI etc. to be followed and complied by the successful bidders ab-initio and throughout the contract period for each machine / site. Any <b>new</b> future guidelines /advisory by any statutory / <b>regulatory</b> authority shall be complied <del>without any cost to the Bank</del> <b>with mutually agreed terms &amp; conditions and within the timeline advised by the authority.</b>

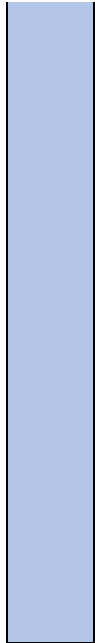

complied without any  
cost to the Bank.

13	1.2.11	1.2.2 Site Implementation Services (SIS)	All existing Compliances of Guidelines / Advisory / Orders/ statutory Instructions/ SOP issued by Bank, State / District / Local Administration / GoI / IBA / RBI / MHA / NPCI etc. to be followed and complied by the successful bidders ab-initio and throughout the contract period for each machine / site. Any future guidelines/advisory by any statutory authority shall be complied without any cost to the Bank.	For implementation of any future guidelines which are not mentioned in this RFP, Bank shall pay for the implementation of the same in the field at mutually agreed price	<b>CORRIGENDUM:</b> All existing Compliances of Guidelines / Advisory / Orders/ statutory Instructions/ SOP issued by Bank, State / District / Local Administration / GoI / IBA / RBI / MHA / NPCI etc. to be followed and complied by the successful bidders ab-initio and throughout the contract period for each machine / site. Any <b>new</b> future guidelines /advisory by any statutory / <b>regulatory</b> authority shall be complied <del>without any cost to the Bank</del> <b>with mutually agreed terms &amp; conditions and within the timeline advised by the authority.</b>
----	--------	--	---	--	---

13	1.2.11	<p>All existing Compliances of Guidelines / Advisory / Orders/ statutory Instructions/ SOP issued by Bank, State / District / Local Administration / GoI / IBA / RBI / MHA / NPCI etc. to be followed and complied by the successful bidders ab-initio and throughout the contract period for each machine / site. Any future guidelines/advisory by any statutory authority shall be complied without any cost to the Bank.</p>	<p>All existing Compliances of Guidelines / Advisory / Orders/ statutory Instructions/ SOP issued by Bank, State / District / Local Administration / GoI / IBA / RBI / MHA / NPCI etc. to be followed and complied by the successful bidders ab-initio and throughout the contract period for each machine / site. Any future guidelines/advisory by any statutory authority shall be complied without any cost to the Bank.</p>	<p>Regulatory changes are not in any one's control, therefore, future guidelines/ advisory and compliance thereof can only be handled through mutual agreement at the time when such guidelines come into force.</p>	<p><b>CORRIGENDUM:</b>  All existing Compliances of Guidelines / Advisory / Orders/ statutory Instructions/ SOP issued by Bank, State / District / Local Administration / GoI / IBA / RBI / MHA / NPCI etc. to be followed and complied by the successful bidders ab-initio and throughout the contract period for each machine / site. Any <b>new</b> future guidelines /advisory by any statutory / <b>regulatory</b> authority shall be complied <del>without any cost to the Bank</del> <b>with mutually agreed terms &amp; conditions and within the timeline advised by the authority.</b></p>
----	--------	--	--	--	--



13	1.2.11	<p>All existing Compliances of Guidelines / Advisory / Orders/ statutory Instructions/ SOP issued by Bank, State / District / Local Administration / Gol / IBA / RBI / MHA / NPCI etc. to be followed and complied by the successful bidders ab-initio and throughout the contract period for each machine / site. Any future guidelines/advisory by any statutory authority shall be complied without any cost to the Bank.</p>	<p>All existing Compliances of Guidelines / Advisory / Orders/ statutory Instructions/ SOP issued by Bank, State / District / Local Administration / Gol / IBA / RBI / MHA / NPCI etc. to be followed and complied by the successful bidders ab-initio and throughout the contract period for each machine / site. Any future guidelines/advisory by any statutory authority shall be complied without any cost to the Bank.</p>	<p>For implementation of any future guidelines which are not mentioned in this RFP, Bank shall pay for the implementation of the same in the field at mutually agreed price</p>	<p><b>CORRIGENDUM:</b>  All existing Compliances of Guidelines / Advisory / Orders/ statutory Instructions/ SOP issued by Bank, State / District / Local Administration / Gol / IBA / RBI / MHA / NPCI etc. to be followed and complied by the successful bidders ab-initio and throughout the contract period for each machine / site. Any <b>new</b> future guidelines /advisory by any statutory / <b>regulatory</b> authority shall be complied <del>without any cost to the Bank</del> <b>with mutually agreed terms &amp; conditions and within the timeline advised by the authority.</b></p>
----	--------	--	--	---	--

13	1.2.11	Invitation to bid	<p>All existing Compliances of Guidelines / Advisory / Orders/ statutory Instructions/ SOP issued by Bank, State / District / Local Administration / GoI / IBA / RBI / MHA / NPCI etc. to be followed and complied by the successful bidders ab-initio and throughout the contract period for each machine / site. Any future guidelines/advisory by any statutory authority shall be complied without any cost to the Bank.</p>	<p>Bidder will comply to all regulatory compliance as on date of bid submission. Subsequent future guidelines/advisory needs to be discussed and mutually agreed at an incremental price</p>	<p><b>CORRIGENDUM:</b>  All existing Compliances of Guidelines / Advisory / Orders/ statutory Instructions/ SOP issued by Bank, State / District / Local Administration / GoI / IBA / RBI / MHA / NPCI etc. to be followed and complied by the successful bidders ab-initio and throughout the contract period for each machine / site. Any <b>new</b> future guidelines /advisory by any statutory / <b>regulatory</b> authority shall be complied <del>without any cost to the Bank</del> <b>with mutually agreed terms &amp; conditions and within the timeline advised by the authority.</b></p>
----	--------	-------------------	--	--	--

13	1.2.11	INVITATION TO BID	<p>All existing Compliances of Guidelines / Advisory / Orders/ statutory Instructions/ SOP issued by Bank, State / District / Local Administration / GoI / IBA / RBI / MHA / NPCI etc. to be followed and complied by the successful bidders ab-initio and throughout the contract period for each machine / site. Any future guidelines/advisory by any statutory authority shall be complied without any cost to the Bank.</p>	<p>Would request the Bank to change this point basis mutually agreed terms.</p> <p>As per OEM 2 - Although ATM will comply to all regulatory compliance as on date of bid submission. Subsequent future guidelines/advisory needs to be discussed and mutually agreed at an incremental price</p>	<p><b>CORRIGENDUM:</b>  All existing Compliances of Guidelines / Advisory / Orders/ statutory Instructions/ SOP issued by Bank, State / District / Local Administration / GoI / IBA / RBI / MHA / NPCI etc. to be followed and complied by the successful bidders ab-initio and throughout the contract period for each machine / site. Any <b>new</b> future guidelines /advisory by any statutory / <b>regulatory</b> authority shall be complied <del>without any cost to the Bank</del> <b>with mutually agreed terms &amp; conditions and within the timeline advised by the authority.</b></p>
----	--------	-------------------	--	---	--

13	1.2.11	Site Implementation Services (SIS)	<p>All existing Compliances of Guidelines / Advisory / Orders/ statutory Instructions/ SOP issued by Bank, State / District / Local Administration / GoI / IBA / RBI / MHA / NPCI etc. to be followed and complied by the successful bidders ab-initio and throughout the contract period for each machine / site. Any future guidelines/advisory by any statutory authority shall be complied without any cost to the Bank.</p>	<p>Bidder will comply to all regulatory compliance as on date of bid submission. Subsequent future guidelines/advisory needs to be discussed and mutually agreed at an incremental price</p>	<p><b>CORRIGENDUM:</b>  All existing Compliances of Guidelines / Advisory / Orders/ statutory Instructions/ SOP issued by Bank, State / District / Local Administration / GoI / IBA / RBI / MHA / NPCI etc. to be followed and complied by the successful bidders ab-initio and throughout the contract period for each machine / site. Any <b>new</b> future guidelines /advisory by any statutory / <b>regulatory</b> authority shall be complied <del>without any cost to the Bank</del> <b>with mutually agreed terms &amp; conditions and within the timeline advised by the authority.</b></p>
----	--------	------------------------------------	--	--	--

13	1.2.11		<p>All existing Compliances of Guidelines / Advisory / Orders/ statutory Instructions/ SOP issued by Bank, State / District / Local Administration / GoI / IBA / RBI / MHA / NPCI etc. to be followed and complied by the successful bidders ab-initio and throughout the contract period for each machine / site. Any future guidelines/advisory by any statutory authority shall be complied without any cost to the Bank.</p>	<p>Request the bank to exclude cost of future compliances from the scope.</p>	<p><b>CORRIGENDUM:</b>  All existing Compliances of Guidelines / Advisory / Orders/ statutory Instructions/ SOP issued by Bank, State / District / Local Administration / GoI / IBA / RBI / MHA / NPCI etc. to be followed and complied by the successful bidders ab-initio and throughout the contract period for each machine / site. Any <b>new</b> future guidelines /advisory by any statutory / <b>regulatory</b> authority shall be complied <del>without any cost to the Bank</del> <b>with mutually agreed terms &amp; conditions and within the timeline advised by the authority.</b></p>
----	--------	--	--	---	--

13	1.2.11  1.2.13	INVITATION TO BID:	<p>All existing Compliances of Guidelines / Advisory / Orders/ statutory Instructions/ SOP issued by Bank, State / District / Local Administration / GoI / IBA / RBI / MHA / NPCI etc. to be followed and complied by the successful bidders ab-initio and throughout the contract period for each machine / site. <u>Anyfutureguidelines/ advisory by any statutory authority shall be complied without any cost to the Bank.</u></p> <p>Vendor to comply with Bank's IS Policy, as updated from time to time <u>without any additional cost to the Bank.</u></p>	<p>Bidder would like to clarify that, if there is any cost impact on the scope of services due to change in law, regulation, guidelines or required by Bank, that cost will be borne by the Bank as Bidder can not assume the future requirement. Cost on any future upgrade will be on mutually agreed basis.</p>	<p><b>CORRIGENDUM:</b> All existing Compliances of Guidelines / Advisory / Orders/ statutory Instructions/ SOP issued by Bank, State / District / Local Administration / GoI / IBA / RBI / MHA / NPCI etc. to be followed and complied by the successful bidders ab-initio and throughout the contract period for each machine / site. Any <b>new</b> future guidelines /advisory by any statutory / <b>regulatory</b> authority shall be complied <del>without any cost to the Bank</del> <b>with mutually agreed terms &amp; conditions and within the timeline advised by the authority.</b> Vendor to comply with Bank's IS Policy, as updated from time to time without any additional cost to the Bank.</p>
----	----------------------	--------------------	--	--	---

13	1.2.13	Vendor to comply with Bank's IS Policy, as updated from time to time without any additional cost to the Bank.	Vendor to comply with Bank's IS Policy, as updated from time to time without any additional cost to the Bank.	Since Bidder do not have any access of Banks Information Security Policy, we request Bank to consider and modify the clause as update will be provided at mutually agreed cost.	Terms & Conditions applicable as per RFP
13	1.2.5	1. INVITATION TO BID	Cash Replenishment Services / Cash Evacuation Services with lockable cassette swap method (Mandatory ab-initio) for all machines, usage of OTC (One time Combination) in vault locks of machines ab-initio. Vendors to arrange and maintain (including replacement of faulty ones) for all set(s) of lockable cassettes + reject / retract / counterfeit bins, as and when required, during the entire contract period and extensions thereof.	Cassette swap implementation is currently getting implemented as per the plan submitted by the sub committee formed by RBI and chaired by IBA. Request to clarify whether the same plan will be followed for this project.	Terms & Conditions applicable as per RFP

13	1.2.5	Cash Replenishment Services / Cash Evacuation Services	Cash Replenishment Services / Cash Evacuation Services with lockable cassette swap method (Mandatory ab-initio) for all machines, usage of OTC (One time Combination) in vault locks of machines ab-initio. Vendors to arrange and maintain (including replacement of faulty ones) for all set(s) of lockable cassettes + reject / retract / counterfeit bins, as and when required, during the entire contract period and extensions thereof.	(a)What about non Vault site for lockable cassette swap method. How can this be implemented there? Requesting bank to exclude the Cassette swapping for non-vaulting location. The IBA has already given the relaxation	Terms & Conditions applicable as per RFP. It is a regulatory Guidelines.
----	-------	--	--	---	--



13	1.2.5	INVITATION TO BID	Cash Replenishment Services / Cash Evacuation Services with lockable cassette swap method (Mandatory ab-initio) for all machines, usage of OTC (One time Combination) in vault locks of machines ab-initio. Vendors to arrange and maintain (including replacement of faulty ones) for all set(s) of lockable cassettes + reject / retract / counterfeit bins, as and when required, during the entire contract period and extensions the	Since cassettes will happened using lock /tagging mechanism by the CRA, during the cassette swap process. Accordingly, CRA's custodians can't open the cassettes at ATM site for its cash verification process and Bank officials required to visit the CRA's hub for checking the video footage of loading and unloading cash, as well as the records being kept there. In case Bank wants to follow another cash verification process then kindly arrange to share the same with Bidder.	Terms & Conditions applicable as per RFP
13	1.2.9	Invitation to Bid	Housekeeping Services will be optional services and Bank may take this service as per the requirements mentioned in this RFP. The additional per successful transaction rate will be derived under optional item of price bid.	Housekeeping Services will be optional services and Bank may take this service as per the requirements mentioned in this RFP. In case bank wishes to take over housekeeping - it has to provide at least three month notice to the vendors	<b>CORRIGENDUM:</b> Housekeeping Services will be optional services and Bank may take this service as per the requirements mentioned in this RFP. The additional per successful transaction rate will be derived under optional item of price bid. <b>Bank shall withdraw housekeeping services, if allotted, anytime during contract period and extension</b>

					thereof by furnishing one month notice to bidder(s).
13		1.2.11	All existing Compliances of Guidelines / Advisory / Orders/ statutory Instructions/ SOP issued by Bank, State / District / Local Administration / GoI / IBA / RBI / MHA / NPCI etc. to be followed and complied by the successful bidders ab-initio and throughout the contract period for each machine / site. Any future guidelines/advisory by any statutory authority shall be complied without any cost to the Bank.	Bidder will comply to all regulatory compliance as on date of bid submission. Subsequent future guidelines/advisory needs to be discussed and mutually agreed at an incremental price	<b>CORRIGENDUM:</b> All existing Compliances of Guidelines / Advisory / Orders/ statutory Instructions/ SOP issued by Bank, State / District / Local Administration / GoI / IBA / RBI / MHA / NPCI etc. to be followed and complied by the successful bidders ab-initio and throughout the contract period for each machine / site. Any <b>new</b> future guidelines /advisory by any statutory / <b>regulatory</b> authority shall be complied <del>without any cost to the Bank</del> <b>with mutually agreed terms &amp; conditions and within the timeline advised by the authority.</b>

13		1.2.7	Implementation of External Digital Signage Solution (EDSS) alongwith its maintenance as per Bank's requirements and demand during full contract period (site selection for EDSS shall be as per Bank's discretion and binding to Vendor(s)).	This is new technology and currently there are not many vendors who can provide and support the same for the contract period of 7 years and showing difficulty to provide service in Non Metro locations .  Also Bank to clarify either percentage of the total sites that Bank intends to deploy or mention the quantity as this is high price item and bidder cannot budget the same as per the TCO percentage which itself we consider is very low and should be in range of 30% of the Financial transaction rate discovered through the TCO	Terms & Conditions applicable as per RFP
14	1.2.13	Invitation to Bid	1.2.13 Vendor to comply with Bank's IS Policy, as updated from time to time without any additional cost to the Bank.	Requesting bank to confirm on IS policy. We request bank to consider mutual agreed cost for any update in IS policy because this is beyond bidder control	Terms & Conditions applicable as per RFP.
14	1.2.13	1.2.2 Site Implementation Services (SIS)	Vendor to comply with Bank's IS Policy, as updated from time to time without any additional cost to the Bank.	Since Bidder do not have any access of Banks Information Security Policy, we request Bank to consider and modify the clause as update will be provided at mutually agreed cost.	Terms & Conditions applicable as per RFP

15	2. DISCLAIMER	DISCLAIMER	2.7. The issue of this RFP does not imply that the Bank is bound to select a Bidder or to award the contract to the Selected Bidder, as the case may be, for the Project and the Bank reserves the right to reject all or any of the Bids or Bidders without assigning any reason whatsoever before issuance of purchase order and / or its acceptance thereof by the successful Bidder as defined in Award Criteria and Award of Contract in this RFP.	Requested Changes : Bank shall not reject bid without assigning any reason whatsoever.	Terms & Conditions applicable as per RFP
15	2.8.	2. DISCLAIMER:	The terms and conditions written in this RFP document shall supersede any conflicting terms and conditions mentioned in GeM portal. The Bank's interpretations and decisions will be final and binding on the bidders.	Request Bank to avoid H1 Elimination Criteria as mentioned in GeM portal.	Terms & Conditions applicable as per RFP

16	3.4	Definitions	3.4 Agreement / Service Level Agreement (SLA) means an agreement is a promise or commitment given by one party to another party. It includes an offer that is made by Bank after reverse auction and accepted by the Vendor(s).	Business to note that the bid offer shall also include reverse auction. The Bidder shall have to accept such reverse auction.	Terms & Conditions applicable as per RFP
16	3.7	3. DEFINITIONS:	Total Outsourced Model i.e. Per Successful Transaction based END to END solutions of the scope of works under this RFP including Installation, testing, commissioning, deployment and maintenance, services of all Machines Hardware's including all Physical and Digital Security	What does Physical & Digital Security mean? These are not defined terms in the RFP, Bidder needs clarity on the same. We request bank to give more clarity on this.	Terms & Conditions applicable as per RFP

16	3.7	<p>Total Outsourced Model i.e. Per Successful Transaction based END to END solutions of the scope of works under this RFP including Installation, testing, commissioning, deployment and maintenance, services of all Machines Hardware's including all Physical and Digital Security</p>	<p>Total Outsourced Model i.e. Per Successful Transaction based END to END solutions of the scope of works under this RFP including Installation, testing, commissioning, deployment and maintenance, services of all Machines Hardware's including all Physical and Digital Security</p>	<p>What does Physical &amp; Digital Security mean? These are not defined terms in the RFP, Bidder needs clarity on the same. We request bank to give more clarity on this.</p>	<p>Terms &amp; Conditions applicable as per RFP</p>
----	-----	---	---	--	---

18	3.16	DEFINITIONS	<p>“VIP Endpoints” are those endpoints which have been installed at Prime / VIP like Airports, In-touch Branches, E-corners / e-lobby, Railway / Metro Stations, shopping malls, Market Areas, Tech Parks, Important/ main Bank Branches or any other location as identified by the Circles. Bank shall identify specific endpoints not exceeding 20% of the endpoints allocated to the respective successful bidder(s) under this RFP as 'VIP Endpoints'. The list of VIP Endpoints can be reviewed by the Bank from time to time.</p>	<p>The limit of 20% for VIP endpoints is high. We request Bank to reduce the limit to a reasonable level of 5% of the total sites.</p>	<p><b>CORRIGENDUM:</b>  “VIP Endpoints” are those endpoints which have been installed at Prime / VIP like Airports, In-touch Branches, E-corners / e-lobby, Railway / Metro Stations, shopping malls, Market Areas, Tech Parks, Important/ main Bank Branches or any other location as identified by the Circles. Bank shall identify specific endpoints not exceeding <del>20</del> <b>05</b>% of the endpoints allocated to the respective successful bidder(s) under this RFP as 'VIP Endpoints'. The list of VIP Endpoints can be reviewed by the Bank from time to time.</p>
----	------	-------------	---	--	---

18	3.16	DEFINITIONS	<p>“VIP Endpoints” are those endpoints which have been installed at Prime / VIP like Airports, In-touch Branches, E-corners / e-lobby, Railway / Metro Stations, shopping malls, Market Areas, Tech Parks, Important/ main Bank Branches or any other location as identified by the Circles. Bank shall identify specific endpoints not exceeding 20% of the endpoints allocated to the respective successful bidder(s) under this RFP as 'VIP Endpoints'. The list of VIP Endpoints can be reviewed by the Bank from time to time.</p>	<p>The VIP Endpoints are high rental sites. Some sites can have significantly high rentals depending on the location. We request Bank to consider a capping of rentals for the vendor for these sites. We request Bank to consider the following change: When Bank desires / insists on any specific Site and rent of which is higher than Rs. 25,000 per month, the Bank will bear the additional amount (i.e. monthly amount more than Rs. 25,000) by reimbursing the same to the Vendor. We request Bank to consider other Bank RFPs which have adopted similiar formula</p>	<p><b>CORRIGENDUM:</b>  “VIP Endpoints” are those endpoints which have been installed at Prime / VIP like Airports, In-touch Branches, E-corners / e-lobby, Railway / Metro Stations, shopping malls, Market Areas, Tech Parks, Important/ main Bank Branches or any other location as identified by the Circles. Bank shall identify specific endpoints not exceeding <del>20</del> <b>05</b>% of the endpoints allocated to the respective successful bidder(s) under this RFP as 'VIP Endpoints'. The list of VIP Endpoints can be reviewed by the Bank from time to time.</p>
19	3.26	Successful Transactions	<p>means following undernoted transactions which are logged into switch with response code 000 or 001 without any reversals, are only</p>	<p>We request bank to clarify for the transaction which logged into switch but requested balance is not available in customer account.</p>	<p>Terms &amp; Conditions applicable as per RFP</p>



			eligible for the payment of invoices		
19	3.26.1	Successful Transactions	Financial (@ discovered per successful Financial Transaction rate): (i) Cash Withdrawals with no reversal (ii) Cash withdrawals through Conversion of Digital Rupee (issued by RBI) with no reversal.	We request bank to clarify and add the other digital withdrawals through (Yono etc.)	Terms & Conditions applicable as per RFP

19	3.26.1	Successful Transactions - Successful Financial Transaction	<p>“Successful Transactions” means following undernoted transactions which are logged into switch with response code 000 or 001 without any reversals, are only eligible for the payment of invoices: -</p> <p>3.26.1 Financial (@ discovered per successful Financial Transaction rate):</p> <p>(i) Cash Withdrawals with no reversal;</p> <p>(ii) Cash withdrawals through Conversion of Digital Rupee (issued by RBI) with no reversal</p>	Request bank to add Non-Cash Financial transactions to this list	Terms & Conditions applicable as per RFP
----	--------	---	---	--	--

20	3.25	Non-Financial Transaction	<p>Non-Financial transaction" means any transaction logged in the switch which does not result in cash withdrawal through the ATM. Example of non financial transactions: balance enquiry / mini-statement / PIN-change / and other Value-added services transaction / insufficient funds transaction / wrong pin transaction by the switch and are considered as payable to the Vendor</p>	<p>Request bank to add -</p> <ol style="list-style-type: none"> <li>1) Declined transactions</li> <li>2) Transaction declined due to Wrong account selection (Current instead of Savings)</li> <li>3) Expired Card</li> <li>4) Exceeded Withdrawal limits</li> <li>5) Inactive Card</li> <li>6) Exceeds Funds Available</li> <li>7) USES LIMIT EXCEEDED</li> <li>8) Exceed Withdrawal Limit</li> <li>9) PIN TRIES EXCEEDED</li> <li>10) EXTERNAL DECLINE</li> <li>11) Fallback decline 05 Do not honor U8 Fallback Decline</li> <li>12) SECURITY VIOLATION/INVALID PIN FORMAT/PIN LENGTH ERROR/PIN KEY ERROR</li> </ol>	<p>Terms &amp; Conditions applicable as per RFP</p>
----	------	---------------------------	---	---	---

20	3.26.2	Successful Transactions - Successful Non-Financial Transaction	<p>3.26“Successful Transactions” means following undernoted transactions which are logged into switch with response code 000 or 001 without any reversals, are only eligible for the payment of invoices: -</p> <p>3.26.1 Financial (@ discovered per successful Financial Transaction rate):</p> <p>(i) Cash Withdrawals with no reversal;</p> <p>(ii) Cash withdrawals through Conversion of Digital Rupee (issued by RBI) with no reversal.</p> <p>3.26.2 Non-Financial (@ discovered per non-Financial Transaction rate):</p> <p>(i) Balance enquiries;</p> <p>(ii) Mini Statements;</p> <p>(iii) PIN Changes;</p> <p>(iv)Value-added services transactions;</p> <p>(v) Non-Cash Financial Transactions like Trust</p>	Insufficient Fund Transactions and Wrong PIN Transactions are not logged into the switch with 000 or 001. Request the bank to remove / edit the clause or modify it to include the response code generated by Insufficient Fund transactions and wrong PIN transactions	Terms & Conditions applicable as per RFP
----	--------	---	--	---	--

		<p>Donation etc.;</p> <p>(vi)Insufficient Fund Transactions;</p> <p>(vii)Wrong PIN Transactions</p> <p>Note: Transactions involving multiple legs shall be considered as one transaction for payment.</p>		
--	--	---	--	--

22	3.43	Definition: ATM Loss	<p>“ATM Loss” means loss of Valuables from a single ATM in respect of which the services are provided. The amount of loss is the face value of the Currency or valuable lost, plus the reasonable cost of reconstructing the negotiable instruments or other items of value (including re-issuance and stop-payment fees), stolen, lost or destroyed as a direct result of the Occurrence. ATM Losses also includes any loss of Valuables occurring outside the immediate physical proximity of the ATM, including but not limited to losses occurring while such Currency notes or Valuables are in transit or are in storage at a vault or similar location. The amount of an</p>	<p>The ONUS of correct verification should be with the Bank. Bank's mistakes should not be attributable to the Bidder</p>	<p>Terms &amp; Conditions applicable as per RFP</p>
----	------	----------------------	---	---	---

ATM Loss also includes the face value of stolen, lost or destroyed negotiable instruments or other items of value, or any loss of any nature to the extent such loss results from:

- ATM equipment malfunction;
- mistakes in ATM loading, including but not limited to, Currency dispensed due to mis-loaded denominations, mis-configured cassettes, or mis-loaded cassettes etc.;
- discrepancies between network reports and ATM bill counter totals (in the event of such discrepancies, bill counter totals shall be deemed conclusive);
- Bank's mistakes in verification;
- burglary; or
- damage from

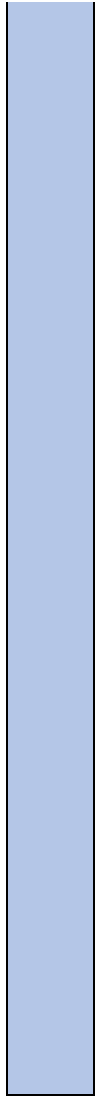

breakage;  
➤ Vandalism etc.



22	3.43  2.1.43	DEFINITIONS	<p>The amount of an ATM Loss also includes the face value of stolen, lost or destroyed negotiable instruments or other items of value, or any loss of any nature to the extent such loss results from:</p> <ul style="list-style-type: none"> <li>➤ ATM equipment malfunction;</li> <li>➤ mistakes in ATM loading, including but not limited to, Currency dispensed due to mis-loaded denominations, mis-configured cassettes, or mis-loaded cassettes etc.;</li> <li>➤ discrepancies between network reports and ATM bill counter totals (in the event of such discrepancies, bill counter totals shall be deemed conclusive);</li> <li>➤ Bank's mistakes in verification;</li> <li>➤ burglary; or</li> <li>➤ damage from</li> </ul>	<p>Bidder requests the Bank to exclude the below reasons from the definition of ATM Loss.</p> <ul style="list-style-type: none"> <li>➤ discrepancies between network reports and ATM bill counter totals (in the event of such discrepancies, bill counter totals shall be deemed conclusive);</li> <li>➤ Bank's mistakes in verification;</li> <li>➤ burglary; or</li> <li>➤ damage from breakage;</li> <li>➤ vandalism etc</li> <li>➤ access by third parties, unless it is proved that such access was facilitated by FSS or its subcontractor;</li> <li>➤ the use of forged or stolen debit and credit cards</li> </ul> <p>Bidder will not be liable for these reasons.</p>	Terms & Conditions applicable as per RFP
----	--------------------	-------------	---	---	--

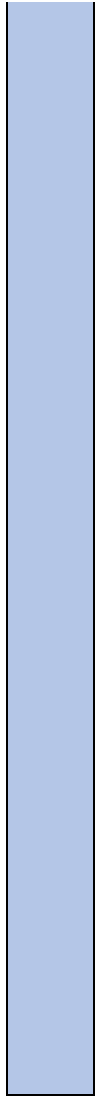

breakage;  
➤ vandalism etc

24	5.2	Bidders to note that: -	1) The ATM machine of a particular OEM can be supplied by either the OEM themselves OR through their authorized dealers / bidders only. In cases where the manufacturer/ OEM has submitted the bid, the bids of its authorized dealer / bidder will not be considered and EMD will be returned.	The bidder request the bank to remove the clause.	<b>CORRIGENDUM:</b> <del>The ATM machine of a particular OEM can be supplied by either the OEM themselves OR through their authorized dealers / bidders only. In cases where the manufacturer/ OEM has submitted the bid, the bids of its authorized dealer / bidder will not be considered and EMD will be returned.</del>
24	5.2.2	5. ELIGIBILITY AND TECHNICAL CRITERIA:	The ATM machine of a particular OEM can be supplied by either the OEM themselves OR through their authorized dealers / bidders only. In cases where the manufacturer/ OEM has submitted the bid, the bids of its authorized dealer / bidder will not be considered and EMD will be returned.	We request Bank to modify this clause as" If a Bidder is a authorized Distrubutor or Authorised Manufacturer in India for an OEM, that OEM should not allow to give MAF to other particpating Bidder".	<b>CORRIGENDUM:</b> <del>The ATM machine of a particular OEM can be supplied by either the OEM themselves OR through their authorized dealers / bidders only. In cases where the manufacturer/ OEM has submitted the bid, the bids of its authorized dealer / bidder will not be considered and EMD will be returned.</del>

24	5.2.2	5.2.2	<p>The ATM machine of a particular OEM can be supplied by either the OEM themselves OR through their authorized dealers / bidders only. In cases where the manufacturer/ OEM has submitted the bid, the bids of its authorized dealer / bidder will not be considered and EMD will be returned.</p>	<p>From the Definition of (Clause 3.10 Page No 17) - "Applicant / Bidder / Service Provider / System Integrator", (Clause 3.13 Page No 18) - "Services" &amp; (Clause 1.4 -1- Invitation to Bid) Bidder shall mean any entity (i.e., juristic person) who meets the eligibility criteria given in Appendix-B of this RFP and willing to provide the Services as required in this RFP.</p> <p>From the above clauses it is amply clear that the RFP is not for supply of Capital Equipment such as ATM machines, ACs, UPS, Batteries etc. The Bank is not purchasing any Capital Equipment from the Bidders as it's a per transaction model pricing. The Bidder is required to provide Services which includes hardware, software products and services. hence, Section 5.2.2 of the RFP (Pg24) which is reproduced below is not relevant for Services to be provided On Per Successful Transactions Rate Basis, under Total Outsourced Model (TOM) and should be changed.</p> <p>Whether it is an OEM or an</p>	<p><b>CORRIGENDUM:</b>  <del>The ATM machine of a particular OEM can be supplied by either the OEM themselves OR through their authorized dealers / bidders only. In cases where the manufacturer/ OEM has submitted the bid, the bids of its authorized dealer / bidder will not be considered and EMD will be returned.</del></p>
----	-------	-------	---	---	---

authorized dealer, all the entities are required to provide Services in the capacity of a Service Provider and hence, all provisions applicable to be equally applicable to all the services providers irrespectively.

Since the BIDDER is going to be remunerated on transactions , Bidder should have a choice of OEM's for deployment based on the support infrastructure and national presence of the OEM's as he needs to support this contract for 7 years.

We request the Bank to consider our observations favourably and edit section 5.2.2 as "The ATM machine of a particular OEM can be supplied by the OEM themselves who are also service providers and OR through other service providers who are their authorized dealers / bidders only"

24	5.2.2	5.2.2	The ATM machine of a particular OEM can be supplied by either the OEM themselves OR through their authorized dealers / bidders only. In cases where the manufacturer/ OEM has submitted the bid, the bids of its authorized dealer / bidder will not be considered and EMD will be returned.	We request Bank to delete this clause as this would restrict the options of the hardware vendors as majority of the OEM's have own capacity as service providers to participate in this RFP	<b>CORRIGENDUM:</b> <del>The ATM machine of a particular OEM can be supplied by either the OEM themselves OR through their authorized dealers / bidders only. In cases where the manufacturer/ OEM has submitted the bid, the bids of its authorized dealer / bidder will not be considered and EMD will be returned.</del>
24	5.2.2	ELIGIBILITY AND TECHNICAL CRITERIA	The ATM machine of a particular OEM can be supplied by either the OEM themselves OR through their authorized dealers / bidders only. In cases where the manufacturer/ OEM has submitted the bid, the bids of its authorized dealer / bidder will not be considered and EMD will be returned.	We request Bank to clarify whether the OEM, whose authorized dealer is submitting the bid, can also share its MAF with other bidders.	<b>CORRIGENDUM:</b> <del>The ATM machine of a particular OEM can be supplied by either the OEM themselves OR through their authorized dealers / bidders only. In cases where the manufacturer/ OEM has submitted the bid, the bids of its authorized dealer / bidder will not be considered and EMD will be returned.</del>

24	5.2.2	ELIGIBILITY AND TECHNICAL CRITERIA - Note	The ATM machine of a particular OEM can be supplied by either the OEM themselves OR through their authorized dealers / bidders only. In cases where the manufacturer/ OEM has submitted the bid, the bids of its authorized dealer / bidder will not be considered and EMD will be returned.	We have a limited number of OEMs in the industry. If the OEMs decide to bid directly as a bidder, all the Non-OEM players will be either disqualified or have limited options of available OEM to associate with. Hence, we request the Bank for an amendment in this criteria.	<b>CORRIGENDUM:</b> <del>The ATM machine of a particular OEM can be supplied by either the OEM themselves OR through their authorized dealers / bidders only. In cases where the manufacturer/ OEM has submitted the bid, the bids of its authorized dealer / bidder will not be considered and EMD will be returned.</del>
24	5.2.2	ELIGIBILITY AND TECHNICAL CRITERIA:	The ATM machine of a particular OEM can be supplied by either the OEM themselves OR through their authorized dealers / bidders only. In cases where the manufacturer/ OEM has submitted the bid, the bids of its authorized dealer / bidder will not be considered and EMD will be returned.	Considering the volume/limited ATM OEMs & stringent delivery timeline for this project, request Bank for OEM to bid direct as well as with partner for Machine supply.	<b>CORRIGENDUM:</b> <del>The ATM machine of a particular OEM can be supplied by either the OEM themselves OR through their authorized dealers / bidders only. In cases where the manufacturer/ OEM has submitted the bid, the bids of its authorized dealer / bidder will not be considered and EMD will be returned.</del>

24	5.2.2	<p>ELIGIBILITY AND TECHNICAL CRITERIA:</p>	<p>The ATM machine of a particular OEM can be supplied by either the OEM themselves OR through their authorized dealers / bidders only. In cases where the manufacturer/ OEM has submitted the bid, the bids of its authorized dealer / bidder will not be considered and EMD will be returned.</p>	<p>From the Definition of (Clause 3.10 Page No 17) - "Applicant / Bidder / Service Provider / System Integrator", (Clause 3.13 Page No 18) - "Services" &amp; (Clause 1.4 -1- Invitation to Bid) Bidder shall mean any entity (i.e., juristic person) who meets the eligibility criteria given in Appendix-B of this RFP and willing to provide the Services as required in this RFP.</p> <p>From the above clauses it is amply clear that the RFP is not for supply of Capital Equipment such as ATM machines, ACs, UPS, Batteries etc. The Bank is not purchasing any Capital Equipment from the Bidders as it's a per transaction model pricing. The Bidder is required to provide Services which includes hardware, software products and services. hence, Section 5.2.2 of the RFP (Pg24) which is reproduced below is not relevant for Services to be provided On Per Successful Transactions Rate Basis, under Total Outsourced Model (TOM) and should be changed.</p> <p>Whether it is an OEM or an</p>	<p><b>CORRIGENDUM:</b>  <del>The ATM machine of a particular OEM can be supplied by either the OEM themselves OR through their authorized dealers / bidders only. In cases where the manufacturer/ OEM has submitted the bid, the bids of its authorized dealer / bidder will not be considered and EMD will be returned.</del></p>
----	-------	--	---	---	---



authorized dealer, all the entities are required to provide Services in the capacity of a Service Provider and hence, all provisions applicable to be equally applicable to all the services providers irrespectively.

Since the BIDDER is going to be remunerated on transactions , Bidder should have a choice of OEM's for deployment based on the support infrastructure and national presence of the OEM's as he needs to support this contract for 7 years.

We request the Bank to consider our observations favorably and edit section 5.2.2 as "The ATM machine of a particular OEM can be supplied by the OEM themselves who are also service providers and OR through other service providers who are their authorized dealers / bidders only"

24

5.2.2

The ATM machine of a particular OEM can be supplied by either the OEM themselves OR through their authorized dealers / bidders only. In cases where the manufacturer/ OEM has submitted the bid, the bids of its authorized dealer / bidder will not be considered and EMD will be returned.

The ATM machine of a particular OEM can be supplied by either the OEM themselves OR through their authorized dealers / bidders only. In cases where the manufacturer/ OEM has submitted the bid, the bids of its authorized dealer / bidder will not be considered and EMD will be returned.

We request Bank to modify this clause as" If a Bidder is a authorized Distrubutor or Authorised Manufacturer in India for an OEM, that OEM should not allow to give MAF to other particpating Bidder".

**CORRIGENDUM:**

~~The ATM machine of a particular OEM can be supplied by either the OEM themselves OR through their authorized dealers / bidders only. In cases where the manufacturer/ OEM has submitted the bid, the bids of its authorized dealer / bidder will not be considered and EMD will be returned.~~

24	5.2.2.	Bidders to note that	The ATM machine of a particular OEM can be supplied by either the OEM themselves OR through their authorized dealers / bidders only. In cases where the manufacturer/ OEM has submitted the bid, the bids of its authorized dealer / bidder will not be considered and EMD will be returned.	We request bank to clarify our understand to the clause "Our understanding is OEM can't give MAF to other Bidder participating the bid".	<b>CORRIGENDUM:</b> <del>The ATM machine of a particular OEM can be supplied by either the OEM themselves OR through their authorized dealers / bidders only. In cases where the manufacturer/ OEM has submitted the bid, the bids of its authorized dealer / bidder will not be considered and EMD will be returned.</del>
24	5.2.3	Eligibility and Technical Criteria	One bidder can supply ATM machines of one or more OEMs. In this scenario the classification of the bidder as Class I or Class II will be defined based on the local content percentage of the proposed ATM only whichever has the lowest local content percentage	Request bank to change the clause to either average or higher local content percentage	Terms & Conditions applicable as per RFP

24 Clause 5.2.2.  
5. ELIGIBILITY  
AND  
TECHNICAL  
CRITERIA

The ATM machine of a particular OEM can be supplied by either the OEM themselves OR through their authorized dealers / bidders only. In cases where the manufacturer/ OEM has submitted the bid, the bids of its authorized dealer / bidder will not be considered and EMD will be returned.

From the Definition of (Clause 3.10 Page No 17) - "Applicant / Bidder / Service Provider / System Integrator", (Clause 3.13 Page No 18) - "Services" & (Clause 1.4 -1- Invitation to Bid) Bidder shall mean any entity (i.e., juristic person) who meets the eligibility criteria given in Appendix-B of this RFP and willing to provide the Services as required in this RFP.

From the above clauses it is amply clear that the RFP is not for supply of Capital Equipment such as ATM machines, ACs, UPS, Batteries etc. The Bank is not purchasing any Capital Equipment from the Bidders as it's a per transaction model pricing. The Bidder is required to provide Services which includes hardware, software products and services. hence, Section 5.2.2 of the RFP (Pg24) which is reproduced below is not relevant for Services to be provided On Per Successful Transactions Rate Basis, under Total Outsourced Model (TOM) and should be changed.

Whether it is an OEM or an

**CORRIGENDUM:**

~~The ATM machine of a particular OEM can be supplied by either the OEM themselves OR through their authorized dealers / bidders only. In cases where the manufacturer/ OEM has submitted the bid, the bids of its authorized dealer / bidder will not be considered and EMD will be returned.~~

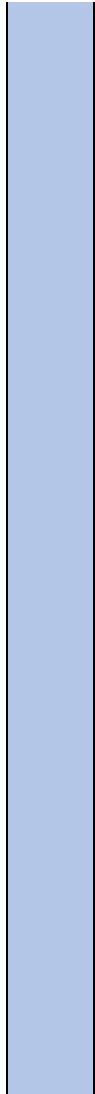

authorized dealer, all the entities are required to provide Services in the capacity of a Service Provider and hence, all provisions applicable to be equally applicable to all the services providers irrespectively.

Since the BIDDER is going to be remunerated on transactions , Bidder should have a choice of OEM's for deployment based on the support infrastructure and national presence of the OEM's as he needs to support this contract for 7 years.

We request the Bank to consider our observations favorably and edit section 5.2.2 as "The ATM machine of a particular OEM can be supplied by the OEM themselves who are also service providers and OR through other service providers who are their authorized dealers / bidders only"

25	5.4	5.4	<p>Bank's MVS, EPS, OMS, other software testing will be a criterion for the successful bidders. The successful bidders must deliver 2 ATM machines which are proposed for installation with 2 UPSs + Fast Charging SMF / Lithium-ion Batteries with atleast 8 hours backup (having Integrated Power Management feature) for testing at the Bank's ATM test Lab located in CBD Belapur, Navi Mumbai within 10 days (calendar days) from the issuance of LOI. The machines have to be tested successfully for OEM / Native software and Bank's MVS, EPS, OMS platform including completion of EMV L3 certification and other softwares from all the scheme (wherever necessary) within 90</p>	<p>The Bidder will provide the XFS and the OS as per the RFP requirement and all necessary technical support during testing however MVS testing is Bank's solution providers responsibility and any changes required to be made by the solution provider to their solution that delays the testing . We request Bank to please consider all these reasons which not attributed to the bidder to be exempted from the time period provided for testing</p>	<p><b>CORRIGENDUM:</b> Bank's MVS, EPS, OMS, other software testing will be a criterion for the successful bidders. The successful bidders must deliver 2 ATM machines which are proposed for installation with 2 UPSs + Fast Charging SMF / Lithium-ion Batteries with atleast 8 hours backup (having Integrated Power Management feature) for testing at the Bank's ATM test Lab located in CBD Belapur, Navi Mumbai <del>within 10 days (calendar days) from the issuance of LOI</del> <b>as per the timeline provided by the Bank.</b> The machines have to be tested successfully for OEM / Native software and Bank's MVS, EPS, OMS platform including completion of EMV L3 certification and other softwares from all the scheme (wherever necessary) within 90 days (calendar days) of delivery of machines. <del>A penalty of Rs 10,000/ per day will be imposed on the bidders if their machines are either undelivered or not tested</del> <b>if any delay (on account of bidder(s)) occurs beyond 15 calendar days either for delivery or successful testing of machines</b> for MVS, EPS, OMS including completion of EMV L3 certification, other software and OEM / Native software within the</p>
----	-----	-----	---	---	--

			<p>days (calendar days) of delivery of machines. A penalty of Rs 10,000/- per day will be imposed on the bidders if their machines are either undelivered or not tested for MVS, EPS, OMS including completion of EMV L3 certification, other software and OEM / Native software within the prescribed timelines. The Bank however has the discretion to review the penalty.</p>		<p>prescribed timelines, the Bank <del>however has the discretion to review the penalty</del> reserves the right to cancel the allotted quantities and allocate such quantities to other successful bidder(s).</p>
--	--	--	--	--	--

25	5.4	<p><b>5. ELIGIBILITY AND TECHNICAL CRITERIA:</b></p>	<p>A penalty of Rs 10,000/- per day will be imposed on the bidders if their machines are either undelivered or not tested for MVS, EPS, OMS including completion of EMV L3 certification, other software and OEM / Native software within the prescribed timelines. The Bank however has the discretion to review the penalty.</p>	<p>The penalty to be charged on CMS only if the default is on part of CMS. If the delay is caused beyond control of CMS then penalty shall not be imposed</p>	<p><b>CORRIGENDUM:</b>  Bank's MVS, EPS, OMS, other software testing will be a criterion for the successful bidders. The successful bidders must deliver <del>2</del> <b>2</b> ATM machines which are proposed for installation with <del>2</del> <b>2</b> UPSs + Fast Charging SMF / Lithium-ion Batteries with at least 8 hours backup (having Integrated Power Management feature) for testing at the Bank's ATM test Lab located in CBD Belapur, Navi Mumbai <del>within 10 days (calendar days) from the issuance of LOI</del> <b>as per the timeline provided by the Bank</b>. The machines have to be tested successfully for OEM / Native software and Bank's MVS, EPS, OMS platform including completion of EMV L3 certification and other softwares from all the scheme (wherever necessary) within 90 days (calendar days) of delivery of machines. <del>A penalty of Rs 10,000/- per day will be imposed on the bidders if their machines are either undelivered or not tested</del> <b>If any delay (on account of bidder(s)) occurs beyond 15 calendar days either for delivery or successful testing of machines</b> for MVS, EPS, OMS including completion of EMV L3 certification, other software and OEM / Native software within the</p>
----	-----	--	--	---	---



					<p>prescribed timelines, the Bank <del>however has the discretion to review the penalty</del> reserves the right to cancel the allotted quantities and allocate such quantities to other successful bidder(s).</p>
--	--	--	--	--	--

25	5.4	<p><b>ELIGIBILITY AND TECHNICAL CRITERIA:</b></p>	<p>Bank's MVS, EPS, OMS, other software testing will be a criterion for the successful bidders. The successful bidders must deliver 2 ATM machines which are proposed for installation with 2 UPSs + Fast Charging SMF / Lithium-ion Batteries with at least 8 hours backup (having Integrated Power Management feature) for testing at the Bank's ATM test Lab located in CBD Belapur, Navi Mumbai within 10 days (calendar days) from the issuance of LOI. The machines have to be tested successfully for OEM / Native software and Bank's MVS, EPS, OMS platform including completion of EMV L3 certification and other software's from all the scheme (wherever necessary) within 90</p>	<p>Please Clarify/Confirm:</p> <p>It is likely that there is duplication of EPS/ATM provision across different participants. There is also a high probability that a certain model is already in the SBI Laboratory being certified, in these cases, due to availability of space in the SBI laboratory, we suggest that SBI limit one sample per OEM/Model, assigning the responsibility of supply to the largest placed (L1,L2...)</p>	<p><b>CORRIGENDUM:</b></p> <p>Bank's MVS, EPS, OMS, other software testing will be a criterion for the successful bidders. The successful bidders must deliver <del>2</del> <b>2</b> ATM machines which are proposed for installation with <del>2</del> <b>2</b> UPSs + Fast Charging SMF / Lithium-ion Batteries with at least 8 hours backup (having Integrated Power Management feature) for testing at the Bank's ATM test Lab located in CBD Belapur, Navi Mumbai <del>within 10 days (calendar days) from the issuance of LOI</del> <b>as per the timeline provided by the Bank</b>. The machines have to be tested successfully for OEM / Native software and Bank's MVS, EPS, OMS platform including completion of EMV L3 certification and other softwares from all the scheme (wherever necessary) within 90 days (calendar days) of delivery of machines. <del>A penalty of Rs 10,000/ per day will be imposed on the bidders if their machines are either undelivered or not tested</del> <b>if any delay (on account of bidder(s)) occurs beyond 15 calendar days either for delivery or successful testing of machines</b> for MVS, EPS, OMS including completion of EMV L3 certification, other software and OEM / Native software within the</p>
----	-----	---	---	--	--

		<p>days (calendar days) of delivery of machines. A penalty of Rs 10,000/- per day will be imposed on the bidders if their machines are either undelivered or not tested for MVS, EPS, OMS including completion of EMV L3 certification, other software and OEM / Native software within the prescribed timelines. The Bank however has the discretion to review the penalty.</p>		<p>prescribed timelines, the Bank <del>however has the discretion to review the penalty</del> reserves the right to cancel the allotted quantities and allocate such quantities to other successful bidder(s).</p>
--	--	--	--	--

25	5.4	<p>ELIGIBILITY AND TECHNICAL CRITERIA:</p>	<p>A penalty of Rs 10,000/- per day will be imposed on the bidders if their machines are either undelivered or not tested for MVS, EPS, OMS including completion of EMV L3 certification, other software and OEM / Native software within the prescribed timelines. The Bank however has the discretion to review the penalty.</p>	<p>Post Delivery, its Banks responsibility to get MVS testing done. Bidder shall felicitate engineer availability but ownership of MVS lies with Bank as MVS vendor has direct contract with the Bank</p>	<p><b>CORRIGENDUM:</b>  Bank's MVS, EPS, OMS, other software testing will be a criterion for the successful bidders. The successful bidders must deliver <del>2</del> <b>2</b> ATM machines which are proposed for installation with <del>2</del> <b>2</b> UPSs + Fast Charging SMF / Lithium-ion Batteries with at least 8 hours backup (having Integrated Power Management feature) for testing at the Bank's ATM test Lab located in CBD Belapur, Navi Mumbai <del>within 10 days (calendar days) from the issuance of LOI</del> <b>as per the timeline provided by the Bank</b>. The machines have to be tested successfully for OEM / Native software and Bank's MVS, EPS, OMS platform including completion of EMV L3 certification and other softwares from all the scheme (wherever necessary) within 90 days (calendar days) of delivery of machines. <del>A penalty of Rs 10,000/- per day will be imposed on the bidders if their machines are either undelivered or not tested</del> <b>If any delay (on account of bidder(s)) occurs beyond 15 calendar days either for delivery or successful testing of machines</b> for MVS, EPS, OMS including completion of EMV L3 certification, other software and OEM / Native software within the</p>
----	-----	--	--	---	---

					<p>prescribed timelines, the Bank <del>however has the discretion to review the penalty</del> reserves the right to cancel the allotted quantities and allocate such quantities to other successful bidder(s).</p>
--	--	--	--	--	--

25	5.4	<p><b>ELIGIBILITY AND TECHNICAL CRITERIA:</b></p>	<p>Bank's MVS, EPS, OMS, other software testing will be a criterion for the successful bidders. The successful bidders must deliver 2 ATM machines which are proposed for installation with 2 UPSs + Fast Charging SMF / Lithium-ion Batteries with at least 8 hours backup (having Integrated Power Management feature) for testing at the Bank's ATM test Lab located in CBD Belapur, Navi Mumbai within 10 days (calendar days) from the issuance of LOI. The machines have to be tested successfully for OEM / Native software and Bank's MVS, EPS, OMS platform including completion of EMV L3 certification and other software's from all the scheme (wherever necessary) within 90</p>	<p>The Bidder will provide the XFS and the OS as per the RFP requirement and all necessary technical support during testing however MVS testing is Bank's solution providers responsibility and any changes required to be made by the solution provider to their solution that delays the testing . We request Bank to please consider all these reasons which not attributed to the bidder to be exempted from the time period provided for testing</p>	<p><b>CORRIGENDUM:</b>  Bank's MVS, EPS, OMS, other software testing will be a criterion for the successful bidders. The successful bidders must deliver 2 ATM machines which are proposed for installation with 2 UPSs + Fast Charging SMF / Lithium-ion Batteries with at least 8 hours backup (having Integrated Power Management feature) for testing at the Bank's ATM test Lab located in CBD Belapur, Navi Mumbai <del>within 10 days (calendar days) from the issuance of LOI</del> <b>as per the timeline provided by the Bank.</b> The machines have to be tested successfully for OEM / Native software and Bank's MVS, EPS, OMS platform including completion of EMV L3 certification and other softwares from all the scheme (wherever necessary) within 90 days (calendar days) of delivery of machines. <del>A penalty of Rs 10,000/ per day will be imposed on the bidders if their machines are either undelivered or not tested</del> <b>if any delay (on account of bidder(s)) occurs beyond 15 calendar days either for delivery or successful testing of machines</b> for MVS, EPS, OMS including completion of EMV L3 certification, other software and OEM / Native software within the</p>
----	-----	---	---	---	--

		<p>days (calendar days) of delivery of machines. A penalty of Rs 10,000/- per day will be imposed on the bidders if their machines are either undelivered or not tested for MVS, EPS, OMS including completion of EMV L3 certification, other software and OEM / Native software within the prescribed timelines. The Bank however has the discretion to review the penalty.</p>		<p>prescribed timelines, the Bank <del>however has the discretion to review the penalty</del> reserves the right to cancel the allotted quantities and allocate such quantities to other successful bidder(s).</p>
--	--	--	--	--

25

5.4

**ELIGIBILITY AND TECHNICAL CRITERIA:**

Bank's MVS, EPS, OMS, other software testing will be a criterion for the successful bidders. The successful bidders must deliver 2 ATM machines which are proposed for installation with 2 UPSs + Fast Charging SMF / Lithium-ion Batteries with atleast 8 hours backup (having Integrated Power Management feature) for testing at the Bank's ATM test Lab located in CBD Belapur, Navi Mumbai within 10 days (calendar days) from the issuance of LOI. The machines have to be tested successfully for OEM / Native software and Bank's MVS, EPS, OMS platform including completion of EMV L3 certification and other softwares from all the scheme (wherever necessary) within 90

The Bidder will provide the XFS and the OS as per the RFP requirement and all necessary technical support during testing however MVS testing is Bank's solution providers responsibility and any changes required to be made by the solution provider to their solution that delays the testing . We request Bank to please consider all these reasons which not attributed to the bidder to be exempted from the time period provided for testing

**CORRIGENDUM:**

Bank's MVS, EPS, OMS, other software testing will be a criterion for the successful bidders. The successful bidders must deliver 2 ATM machines which are proposed for installation with 2 UPSs + Fast Charging SMF / Lithium-ion Batteries with atleast 8 hours backup (having Integrated Power Management feature) for testing at the Bank's ATM test Lab located in CBD Belapur, Navi Mumbai ~~within 10 days (calendar days) from the issuance of LOI~~ **as per the timeline provided by the Bank.** The machines have to be tested successfully for OEM / Native software and Bank's MVS, EPS, OMS platform including completion of EMV L3 certification and other softwares from all the scheme (wherever necessary) within 90 days (calendar days) of delivery of machines. ~~A penalty of Rs 10,000/ per day will be imposed on the bidders if their machines are either undelivered or not tested~~ **if any delay (on account of bidder(s)) occurs beyond 15 calendar days either for delivery or successful testing of machines** for MVS, EPS, OMS including completion of EMV L3 certification, other software and OEM / Native software within the



			<p>days (calendar days) of delivery of machines. A penalty of Rs 10,000/- per day will be imposed on the bidders if their machines are either undelivered or not tested for MVS, EPS, OMS including completion of EMV L3 certification, other software and OEM / Native software within the prescribed timelines. The Bank however has the discretion to review the penalty.</p>		<p>prescribed timelines, the Bank <del>however has the discretion to review the penalty</del> reserves the right to cancel the allotted quantities and allocate such quantities to other successful bidder(s).</p>
--	--	--	--	--	--

25

5.4

**ELIGIBILITY AND TECHNICAL CRITERIA:**

Bank's MVS, EPS, OMS, other software testing will be a criterion for the successful bidders. The successful bidders must deliver 2 ATM machines which are proposed for installation with 2 UPSs + Fast Charging SMF / Lithium-ion Batteries with at least 8 hours backup (having Integrated Power Management feature) for testing at the Bank's ATM test Lab located in CBD Belapur, Navi Mumbai within 10 days (calendar days) from the issuance of LOI. The machines have to be tested successfully for OEM / Native software and Bank's MVS, EPS, OMS platform including completion of EMV L3 certification and other software's from all the scheme (wherever necessary) within 90

**Please Clarify/Confirm:**

It is likely that there is duplication of EPS/ATM provision across different participants. There is also a high probability that a certain model is already in the SBI Laboratory being certified, in these cases, due to availability of space in the SBI laboratory, we suggest that SBI limit one sample per OEM/Model, assigning the responsibility of supply to the largest placed (L1,L2...)

**CORRIGENDUM:**

Bank's MVS, EPS, OMS, other software testing will be a criterion for the successful bidders. The successful bidders must deliver 2 ATM machines which are proposed for installation with 2 UPSs + Fast Charging SMF / Lithium-ion Batteries with at least 8 hours backup (having Integrated Power Management feature) for testing at the Bank's ATM test Lab located in CBD Belapur, Navi Mumbai ~~within 10 days (calendar days) from the issuance of LOI~~ **as per the timeline provided by the Bank.** The machines have to be tested successfully for OEM / Native software and Bank's MVS, EPS, OMS platform including completion of EMV L3 certification and other softwares from all the scheme (wherever necessary) within 90 days (calendar days) of delivery of machines. ~~A penalty of Rs 10,000/ per day will be imposed on the bidders if their machines are either undelivered or not tested~~ **if any delay (on account of bidder(s)) occurs beyond 15 calendar days either for delivery or successful testing of machines** for MVS, EPS, OMS including completion of EMV L3 certification, other software and OEM / Native software within the

		<p>days (calendar days) of delivery of machines. A penalty of Rs 10,000/- per day will be imposed on the bidders if their machines are either undelivered or not tested for MVS, EPS, OMS including completion of EMV L3 certification, other software and OEM / Native software within the prescribed timelines. The Bank however has the discretion to review the penalty.</p>		<p>prescribed timelines, the Bank <del>however has the discretion to review the penalty</del> reserves the right to cancel the allotted quantities and allocate such quantities to other successful bidder(s).</p>
--	--	--	--	--

25

5.4

**ELIGIBILITY AND TECHNICAL CRITERIA:**

Bank's MVS, EPS, OMS, other software testing will be a criterion for the successful bidders. The successful bidders must deliver 2 ATM machines which are proposed for installation with 2 UPSs + Fast Charging SMF / Lithium-ion Batteries with at least 8 hours backup (having Integrated Power Management feature) for testing at the Bank's ATM test Lab located in CBD Belapur, Navi Mumbai within 10 days (calendar days) from the issuance of LOI. The machines have to be tested successfully for OEM / Native software and Bank's MVS, EPS, OMS platform including completion of EMV L3 certification and other software's from all the scheme (wherever necessary) within 90

**Please Clarify/Confirm:**

It is likely that there is duplication of EPS/ATM provision across different participants. There is also a high probability that a certain model is already in the SBI Laboratory being certified, in these cases, due to availability of space in the SBI laboratory, we suggest that SBI limit one sample per OEM/Model, assigning the responsibility of supply to the largest placed (L1,L2...)

**CORRIGENDUM:**

Bank's MVS, EPS, OMS, other software testing will be a criterion for the successful bidders. The successful bidders must deliver 2 ATM machines which are proposed for installation with 2 UPSs + Fast Charging SMF / Lithium-ion Batteries with at least 8 hours backup (having Integrated Power Management feature) for testing at the Bank's ATM test Lab located in CBD Belapur, Navi Mumbai ~~within 10 days (calendar days) from the issuance of LOI~~ **as per the timeline provided by the Bank.** The machines have to be tested successfully for OEM / Native software and Bank's MVS, EPS, OMS platform including completion of EMV L3 certification and other softwares from all the scheme (wherever necessary) within 90 days (calendar days) of delivery of machines. ~~A penalty of Rs 10,000/ per day will be imposed on the bidders if their machines are either undelivered or not tested~~ **if any delay (on account of bidder(s)) occurs beyond 15 calendar days either for delivery or successful testing of machines** for MVS, EPS, OMS including completion of EMV L3 certification, other software and OEM / Native software within the

			<p>days (calendar days) of delivery of machines. A penalty of Rs 10,000/- per day will be imposed on the bidders if their machines are either undelivered or not tested for MVS, EPS, OMS including completion of EMV L3 certification, other software and OEM / Native software within the prescribed timelines. The Bank however has the discretion to review the penalty.</p>		<p>prescribed timelines, the Bank <del>however has the discretion to review the penalty</del> reserves the right to cancel the allotted quantities and allocate such quantities to other successful bidder(s).</p>
--	--	--	--	--	--

25 5.4

Bank's MVS, EPS, OMS, other software testing will be a criterion for the successful bidders. The successful bidders must deliver 2 ATM machines which are proposed for installation with 2 UPSs + Fast Charging SMF / Lithium-ion Batteries with at least 8 hours backup (having Integrated Power Management feature) for testing at the Bank's ATM test Lab located in CBD Belapur, Navi Mumbai within 10 days (calendar days) from the issuance of LOI. The machines have to be tested successfully for OEM / Native software and Bank's MVS, EPS, OMS platform including completion of EMV L3 certification and other software's from all the scheme (wherever necessary) within 90

Please Clarify/Confirm:

It is likely that there is duplication of EPS/ATM provision across different participants. There is also a high probability that a certain model is already in the SBI Laboratory being certified, in these cases, due to availability of space in the SBI laboratory, we suggest that SBI limit one sample per OEM/Model, assigning the responsibility of supply to the largest placed (L1,L2...)

**CORRIGENDUM:**

Bank's MVS, EPS, OMS, other software testing will be a criterion for the successful bidders. The successful bidders must deliver 2 ATM machines which are proposed for installation with 2 UPSs + Fast Charging SMF / Lithium-ion Batteries with at least 8 hours backup (having Integrated Power Management feature) for testing at the Bank's ATM test Lab located in CBD Belapur, Navi Mumbai ~~within 10 days (calendar days) from the issuance of LOI~~ **as per the timeline provided by the Bank.** The machines have to be tested successfully for OEM / Native software and Bank's MVS, EPS, OMS platform including completion of EMV L3 certification and other softwares from all the scheme (wherever necessary) within 90 days (calendar days) of delivery of machines. ~~A penalty of Rs 10,000/ per day will be imposed on the bidders if their machines are either undelivered or not tested~~ **if any delay (on account of bidder(s)) occurs beyond 15 calendar days either for delivery or successful testing of machines** for MVS, EPS, OMS including completion of EMV L3 certification, other software and OEM / Native software within the

			<p>days (calendar days) of delivery of machines. A penalty of Rs 10,000/- per day will be imposed on the bidders if their machines are either undelivered or not tested for MVS, EPS, OMS including completion of EMV L3 certification, other software and OEM / Native software within the prescribed timelines. The Bank however has the discretion to review the penalty.</p>		<p>prescribed timelines, the Bank <del>however has the discretion to review the penalty</del> reserves the right to cancel the allotted quantities and allocate such quantities to other successful bidder(s).</p>
--	--	--	--	--	--

25	5.5	5.5	<p>During testing of the supplied machine in the Bank's IT-Lab, if the machine is found to be incompatible with Bank's existing MVS, EPS, OMS, other software, and despite several developments / customizations / modifications by the OEMs, the machine remains incompatible, Bank reserves the right to disqualify that bidder (who supplied that machine) and assign the allocated quota (of this disqualified bidder) to other bidder(s)</p>	<p>The Bidder will provide the XFS and the OS as per the RFP requirement and all necessary technical support during testing however MVS testing is Bank's solution providers responsibility and any changes required to be made by the solution provider to their solution that delays the testing . We request Bank to please consider all these reasons which not attributed to the bidder to be exempted from the time period provided for testing</p>	<p>Terms &amp; Conditions applicable as per RFP</p>
----	-----	-----	---	---	---



25	5.5	Scope of work	<p>During testing of the supplied machine in the Bank's IT-Lab, if the machine is found to be incompatible with Bank's existing MVS, EPS, OMS, other software, and despite several developments / customizations / modifications by the OEMs, the machine remains incompatible, Bank reserves the right to disqualify that bidder (who supplied that machine) and assign the allocated quota (of this disqualified bidder) to other bidder(s) of this RFP whose machine is tested to be compatible. The timeframe for testing Bank's existing MVS, EPS, other software's, and several developments / customizations / modifications by the OEMs to make their machines compatible within 90 calendar</p>	<p><u>As the requirement of Bank's EPS and other Software's will be known only during UAT,</u> Request bank to change clause from "90 days" to "90 days or mutually agreed duration".</p>	<p>Terms &amp; Conditions applicable as per RFP</p>
----	-----	---------------	--	---	---

		<p>days from the date of commencement of testing by the Bank. Bank may, at its sole discretion, provide extensions to this timeframe, if deemed necessary. The penalty mentioned in clause 5.4 above shall be applicable. In case, the machines of any successful bidder found incompatible at any stage, Bank at its sole discretion may allocate its respective quotas to other successful bidder(s). Bank, at its discretion, may give the entire procurement to a single vendor whose machine is tested to be compatible, in case a single bidder situation arises.</p>		
--	--	---	--	--

25	5.5	Scope of work	<p>During testing of the supplied machine in the Bank's IT-Lab, if the machine is found to be incompatible with Bank's existing MVS, EPS, OMS, other software, and despite several developments / customizations / modifications by the OEMs, the machine remains incompatible, Bank reserves the right to disqualify that bidder (who supplied that machine) and assign the allocated quota (of this disqualified bidder) to other bidder(s) of this RFP whose machine is tested to be compatible. The timeframe for testing Bank's existing MVS, EPS, other softwares, and several developments / customizations / modifications by the OEMs to make their machines compatible within 90 calendar</p>	<p><u>As the requirement of Bank's EPS and other Softwares will be known only during UAT,</u> Request bank to change clause from "90 days" to "90 days or mutually agreed duration".</p>	<p>Terms &amp; Conditions applicable as per RFP</p>
----	-----	---------------	---	--	---

		<p>days from the date of commencement of testing by the Bank. Bank may, at its sole discretion, provide extensions to this timeframe, if deemed necessary. The penalty mentioned in clause 5.4 above shall be applicable. In case, the machines of any successful bidder found incompatible at any stage, Bank at its sole discretion may allocate its respective quotas to other successful bidder(s). Bank, at its discretion, may give the entire procurement to a single vendor whose machine is tested to be compatible, in case a single bidder situation arises.</p>		
--	--	---	--	--

25	<p>27.1. Testing of machine and piloting of tested Machines:</p> <p>&amp;</p> <p>5.4 (PAGE 364 &amp; 25)</p>	<p>PROJECT PLAN, DELIVERY AND SCHEDULE</p> <p>ELIGIBILITY AND TECHNICAL CRITERIA</p>	<p>iv. Delivery of test machines (one endpoint of one model of each OEM with atleast 2 Hard disks for each endpoint)</p> <p>&amp;</p> <p>Bank's MVS, EPS, OMS, other software testing will be a criterion for the successful bidders. The successful bidders must deliver 2 ATM machines which are proposed for installation with 2 UPSs + Fast Charging SMF / Lithium-ion Batteries with at least 8 hours backup</p>	<p>In 27.1 clause Bank is asking for 1 machine of each OEM, and whereas in 5.4 Bank is requesting for 2 ATM's.</p> <p>If the bidder is supplying machine of only one OEM then in such case, bidder is required to provide only one test machine.</p> <p>Please clarify</p>	<p>Terms &amp; Conditions applicable as per RFP</p>
----	--	--	---	--	---

25	5.4 & 5.5	ELIGIBILITY AND TECHNICAL CRITERIA - Note	<p>5.4 Bank's MVS, EPS, OMS, other software testing will be a criterion for the successful bidders. The successful bidders must deliver 2 ATM machines which are proposed for installation with 2 UPSs + Fast Charging SMF / Lithium-ion Batteries with at least 8 hours backup (having Integrated Power Management feature) for testing at the Bank's ATM test Lab located in CBD Belapur, Navi Mumbai within 10 days (calendar days) from the issuance of LOI. The machines have to be tested successfully for OEM / Native software and Bank's MVS, EPS, OMS platform including completion of EMV L3 certification and other softwares from all the scheme (wherever necessary) within 90</p>	<p>Bank shall give minimum 3 weeks time for delivering the 2 ATM machines including 2 UPS for testing at CBD Belapur, Navi Mumbai</p> <p>As per ATM OEM 1 - Also it is likely that there is duplication of EPS/ATM provision across different participants. There is also a high probability that a certain model is already in the SBI Laboratory being certified, in these cases, due to unavailability of space in the SBI laboratory, we suggest that SBI limit one sample per OEM/Model, assigning the responsibility of supply to the largest placed bidder (L1,L2, etc.,).</p> <p>As per ATM OEM 2 - The Bidder will provide the XFS and the OS as per the RFP requirement and all necessary technical support during testing. However, MVS testing is Bank's solution providers responsibility and any changes required to be made by the solution provider to its solution, may delays the testing . We request Bank to please consider all these</p>	<p><b>CORRIGENDUM:</b> Bank's MVS, EPS, OMS, other software testing will be a criterion for the successful bidders. The successful bidders must deliver 2 ATM machines which are proposed for installation with 2 UPSs + Fast Charging SMF / Lithium-ion Batteries with at least 8 hours backup (having Integrated Power Management feature) for testing at the Bank's ATM test Lab located in CBD Belapur, Navi Mumbai <del>within 10 days (calendar days) from the issuance of LOI</del> <b>as per the timeline provided by the Bank.</b> The machines have to be tested successfully for OEM / Native software and Bank's MVS, EPS, OMS platform including completion of EMV L3 certification and other softwares from all the scheme (wherever necessary) within 90 days (calendar days) of delivery of machines. <del>A penalty of Rs 10,000/ per day will be imposed on the bidders if their machines are either undelivered or not tested</del> <b>if any delay (on account of bidder(s)) occurs beyond 15 calendar days either for delivery or successful testing of machines</b> for MVS, EPS, OMS including completion of EMV L3 certification, other software and OEM / Native software within the</p>
----	-----------	---	--	--	---

			<p>days (calendar days) of delivery of machines. A penalty of Rs 10,000/- per day will be imposed on the bidders if their machines are either undelivered or not tested for MVS, EPS, OMS including completion of EMV L3 certification, other software and OEM / Native software within the prescribed timelines. The Bank however has the discretion to review the penalty.</p> <p>5.5 During testing of the supplied machine in the Bank's IT-Lab, if the machine is found to be incompatible with Bank's existing MVS, EPS, OMS, other software, and despite several developments / customizations / modifications by the OEMs, the machine remains incompatible, Bank reserves the</p>	<p>reasons which are not attributed to the bidder and shall be exempted from the time period, provided for the testing.</p>	<p>prescribed timelines, the Bank <del>however has the discretion to review the penalty</del> reserves the right to cancel the allotted quantities and allocate such quantities to other successful bidder(s).</p>
--	--	--	--	---	--

			<p>right to disqualify that bidder (who supplied that machine) and assign the allocated quota (of this disqualified bidder) to other bidder(s)</p>		
--	--	--	--	--	--



25	5.5	<p>During testing of the supplied machine in the Bank's IT-Lab, if the machine is found to be incompatible with Bank's existing MVS, EPS, OMS, other software, and despite several developments / customizations / modifications by the OEMs, the machine remains incompatible, Bank reserves the right to disqualify that bidder (who supplied that machine) and assign the allocated quota (of this disqualified bidder) to other bidder(s)</p>	<p>Terms &amp; Conditions applicable as per RFP</p>
----	-----	---	---

Bank's MVS, EPS, OMS, other software testing will be a criterion for the successful bidders. The successful bidders must deliver 2 ATM machines which are proposed for installation with 2 UPSs + Fast Charging SMF / Lithium-ion Batteries with atleast 8 hours backup (having Integrated Power Management feature) for testing at the Bank's ATM test Lab located in CBD Belapur, Navi Mumbai within 10 days (calendar days) from the issuance of LOI. The machines have to be tested successfully for OEM / Native software and Bank's MVS, EPS, OMS platform including completion of EMV L3 certification and other softwares from all the scheme (wherever necessary) within 90

The Bidder will provide the XFS and the OS as per the RFP requirement and all necessary technical support during testing however MVS testing is Bank's solution providers responsibility and any changes required to be made by the solution provider to their solution that delays the testing . We request Bank to please consider all these reasons which not attributed to the bidder to be exempted from the time period provided for testing

**CORRIGENDUM:**

Bank's MVS, EPS, OMS, other software testing will be a criterion for the successful bidders. The successful bidders must deliver 2 ATM machines which are proposed for installation with 2 UPSs + Fast Charging SMF / Lithium-ion Batteries with atleast 8 hours backup (having Integrated Power Management feature) for testing at the Bank's ATM test Lab located in CBD Belapur, Navi Mumbai ~~within 10 days (calendar days) from the issuance of LOI~~ **as per the timeline provided by the Bank.** The machines have to be tested successfully for OEM / Native software and Bank's MVS, EPS, OMS platform including completion of EMV L3 certification and other softwares from all the scheme (wherever necessary) within 90 days (calendar days) of delivery of machines. ~~A penalty of Rs 10,000/ per day will be imposed on the bidders if their machines are either undelivered or not tested~~ **if any delay (on account of bidder(s)) occurs beyond 15 calendar days either for delivery or successful testing of machines** for MVS, EPS, OMS including completion of EMV L3 certification, other software and OEM / Native software within the

		<p>days (calendar days) of delivery of machines. A penalty of Rs 10,000/- per day will be imposed on the bidders if their machines are either undelivered or not tested for MVS, EPS, OMS including completion of EMV L3 certification, other software and OEM / Native software within the prescribed timelines. The Bank however has the discretion to review the penalty.</p>		<p>prescribed timelines, the Bank <del>however has the discretion to review the penalty</del> reserves the right to cancel the allotted quantities and allocate such quantities to other successful bidder(s).</p>
--	--	--	--	--

27	7.3	<b>CLARIFICATIONS AND AMENDMENTS ON RFP / PRE-BID MEETING:</b>	No request for change in commercial / legal terms and conditions, other than what has been mentioned in this RFP or any addenda / corrigenda or clarifications issued in connection thereto, will be entertained and queries in this regard, therefore will not be entertained.	Bidder clarifies that final agreement is subject to queries raised by the Bidder and Bidder's review and mutual discussion between the parties.	Terms & Conditions applicable as per RFP
----	-----	--	---	---	--

28	9.3	EARNEST MONEY DEPOSIT	<p><b>Earnest Money Deposit:</b> The EMD should be in form of Bank Guarantee (as prescribed in EMD FORMAT Appendix-H) issued in favour of State Bank of India by any scheduled commercial bank in India.</p>	<p>We request Bank to allow Insurance Security Bonds as an additional instrument for furnishing EMD as per the govt guidelines. As per 6.1.2 (i) in page 106 of the Manual for Procurement of Goods dated June 2022 by Dept of Expenditure, Procurement Policy Division, Ministry of Finance - Bid Security may be furnished in the form of Insurance Surety Bond. This is also as per Office Memorandum No.F.1/1/2022-PPD dated 02.02.2022 of Dept of Expenditure, Ministry of Finance which made amendments to General Financial Rules (GFR), 2017 regarding 'Bid Security' and 'Performance Security' to include Insurance Surety Bonds as Security Instrument.</p>	Terms & Conditions applicable as per RFP
28	9. EARNEST MONEY DEPOSIT (EMD):	EARNEST MONEY DEPOSIT (EMD):	9.8. The EMD may be forfeited in following conditions: -	Requested Changes : Bank shall not forfeit Earnest Money Deposit without its consent of Bidder.	Terms & Conditions applicable as per RFP

29	9. EARNEST MONEY DEPOSIT (EMD):	EARNEST MONEY DEPOSIT (EMD):	9.8.7. If EMD is forfeited for any reasons mentioned above, the concerned Bidder may be debarred from participating in the RFPs floated by the Bank / this department, in future, as per the sole discretion of the Bank.	Requested Changes : Bank shall not debar concerned Bidder may be debarred from participating in the RFPs floated by the Bank/this department, in future without consent of Bidder.	Terms & Conditions applicable as per RFP
29	9.8.6	EARNEST MONEY DEPOSIT (EMD):	If the machines supplied for services by the successful bidder(s) are incompatible with the Bank's existing MVS, EPS, other software(s), and despite developments / customizations / modifications by the OEMs, machines not become compatible within reasonable time (as deemed fit by bank), the Bank can disqualify the successful bidder(s) as per its sole discretion.	We propose deletion of Clause 9.8 (e) as EMD is to be provided by way of PBG. The Bank can seek comfort from the Performance Bank Guarantee in this scenario and not hold back refund of EMD. Also the Bank is going to have a technical measurement of the machines before deployment and hence request modification.	Terms & Conditions applicable as per RFP

33	10.2.1.17	Bid Preparation and Submission	Bidders should also submit as part of Technical Bid an overview of Project Management approach and their Board Approved Business Continuity Plan (BCP) of the proposed services	Request bank to modify the clause to below - Bidders should also submit as part of Technical Bid an overview of Project Management approach and their Business Continuity Plan (BCP) of the proposed services	Terms & Conditions applicable as per RFP
33	10.2.1.17	Offline document	Bidders should also submit as part of Technical Bid an overview of Project Management approach and their Board Approved Business Continuity Plan (BCP) of the proposed services;	We request bank to remove BCP submission along with technical bid. In such a short notice new BCP can't be approved. The BCP usually review once in a year.	Terms & Conditions applicable as per RFP
34	12. MODIFICATION AND WITHDRAWAL OF BIDS:	MODIFICATION AND WITHDRAWAL OF BIDS:	12.3. No Bid shall be withdrawn in the interval between the deadline for submission of Bids and the expiration of the period of Bid validity specified in this RFP. Withdrawal of a Bid during this interval may result in the forfeiture of EMD	Requested Changes : Bank shall not forfeit Earnest Money Deposit without its consent of Bidder.	Terms & Conditions applicable as per RFP

			submitted by the Bidder.		
35	13.3.2	PERIOD OF BID VALIDITY AND VALIDITY OF PRICE QUOTED IN REVERSE AUCTION (RA)	There would be a 2.5% cap on the annual increase in per Successful Transaction Rates.	<p>Inflation directly impacts the cost of services for the vendor. The CPI rate for India for the last 10 years for the period 2013-2022 has averaged at 5.6% as per actual data (source: Worldbank). With this background, capping the annual increase per successful transaction rate to 2.5% is not reasonable. Capping should be based on historical data and trends.</p> <p>We request the Bank to increase it to minimum 5% to make it operationally viable for the vendors.</p>	Terms & Conditions applicable as per RFP



35	13.3.2	<b>PERIOD OF BID VALIDITY AND VALIDITY OF PRICE QUOTED IN REVERSE AUCTION (RA)</b>	<p>The maximum Per Successful Financial Transaction Rate for Offsite ATMs permitted during the tenure of contract shall be Rs. 2 less than the prevailing interchange fee. If the difference between the increased price and prevailing Interchange fee is less than Rs. 2, then the per successful transaction rate will freeze (without revision) for the residual period of the contract and extension thereof. It will be revised only when the interchange fee is revised by RBI, subject to increased price shall always remain Rs. 02 less than RBI interchange fee.</p>	<p>The present RFP has a price discovery mechanism based on competitive bidding and the scope of services/ BOQ defined by the Bank. This price discovery is not at all connected to prevailing interchange rate. Hence, Bank should not stipulate a predetermined cap on the pricing increase. Such a condition is against the spirit of free market discovery through RFP process. ATM vendors are already under severe cost pressure due to lower interchange, putting a cap of Rs 2 below the interchange will put lot of financial pressure on the vendors which will eventually impact the services.</p> <p>We request the Bank to remove this condition.</p>	<p>Terms &amp; Conditions applicable as per RFP</p>
----	--------	--	---	--	---

35	13.3.2	PERIOD OF BID VALIDITY AND VALIDITY OF PRICE QUOTED IN REVERSE AUCTION (RA)	There would be a 2.5% cap on the annual increase in per Successful Transaction Rates.	Requesting the Bank to consider the actual CPI Inflation which directly impacts the cost of services for the service provider. The Bank can refer the CPI rate of last 10 years.	Terms & Conditions applicable as per RFP
35	13.3.2	PERIOD OF BID VALIDITY AND VALIDITY OF PRICE QUOTED IN REVERSE AUCTION (RA)	The maximum Per Successful Financial Transaction Rate for Offsite ATMs permitted during the tenure of contract shall be Rs. 2 less than the prevailing interchange fee. If the difference between the increased price and prevailing Interchange fee is less than Rs. 2, then the per successful transaction rate will freeze (without revision) for the residual period of the contract and extension thereof. It will be revised only when the interchange fee is revised by RBI, subject to increased price shall always remain Rs. 02 less	The present RFP has a price discovery mechanism based on competitive bidding and the scope of services/ BOQ defined by the Bank. This price discovery is not at all connected to prevailing interchange rate. Hence, Bank should not stipulate a predetermined cap on the pricing increase. Requesting bank to remove this clause.	Terms & Conditions applicable as per RFP

			then RBI interchange fee.		
--	--	--	---------------------------	--	--

35	13.3.2	<p><b>PERIOD OF BID VALIDITY AND VALIDITY OF PRICE QUOTED IN REVERSE AUCTION (RA):</b></p>	<p>There would be a 2.5% cap on the annual increase in per Successful Transaction Rates. The Increment in payment would be directly correlated to the increase in the Index over 12 months period. For e.g., If the index value on 01st May 2023 is 120 which increases to 123 in 01st May 2024 thereby representing a 2.5% increase. The per Successful Transaction Rates would increase proportionately. However, if the index value increases beyond 2.5%, the increase in payment would be capped at 2.5%. The maximum Per Successful Financial Transaction Rate for Offsite ATMs permitted during the tenure of contract shall be Rs. 2 less than the prevailing</p>	<p>Since the price inflation in Bidder's control, limiting/ capping the increment to maximum of Rs. 15 (prevailing Interchange fee is less than Rs. 2) will be challenging for Bidder. Request you to remove the capping of maximum Per Successful Financial Transaction Rate for Offsite ATMs permitted during the tenure of contract shall be Rs. 2 less than the prevailing interchange fee</p>	<p>Terms &amp; Conditions applicable as per RFP</p>
----	--------	--	---	--	---

		<p>interchange fee. If the difference between the increased price and prevailing Interchange fee is less than Rs. 2, then the per successful transaction rate will freeze (without revision) for the residual period of the contract and extension thereof. It will RFP FOR TOM P-XVII 13,500 ATMs Page 36 of 421 be revised only when the interchange fee is revised by RBI, subject to increased price shall always remain Rs. 02 less than RBI interchange fee</p>		
--	--	---	--	--

35	13.3.2.	CPI	<p>There would be a 2.5% cap on the annual increase in per Successful Transaction Rates. The Increment in payment would be directly correlated to the increase in the Index over 12 months period. For e.g., If the index value on 01st May 2023 is 120 which increases to 123 in 01st May 2024 thereby representing a 2.5% increase. The per Successful Transaction Rates would increase proportionately. However, if the index value increases beyond 2.5%, the increase in payment would be capped at 2.5%. The maximum Per Successful Financial Transaction Rate for Offsite ATMs permitted during the tenure of contract shall be Rs. 2 less than the prevailing</p>	<p>We request bank to clarify the clause.  (a) What about delay due to bank dependency  (b) What about delay due to existing vendor</p> <p>We request the bank to give rate increase post 90% completion of the project and from 1 year of the completion of the same.</p>	<p>Terms &amp; Conditions applicable as per RFP</p>
----	---------	-----	---	--	---

		<p>interchange fee. If the difference between the increased price and prevailing Interchange fee is less than Rs. 2, then the per successful transaction rate will freeze (without revision) for the residual period of the contract and extension thereof. It will be revised only when the interchange fee is revised by RBI, subject to increased price shall always remain Rs. 02 less than RBI interchange fee.</p>		
--	--	--	--	--

35	13.3.2.	CPI	<p>There would be a 2.5% cap on the annual increase in per Successful Transaction Rates. The Increment in payment would be directly correlated to the increase in the Index over 12 months period. For e.g., If the index value on 01st May 2023 is 120 which increases to 123 in 01st May 2024 thereby representing a 2.5% increase. The per Successful Transaction Rates would increase proportionately. However, if the index value increases beyond 2.5%, the increase in payment would be capped at 2.5%. The maximum Per Successful Financial Transaction Rate for Offsite ATMs permitted during the tenure of contract shall be Rs. 2 less than the prevailing</p>	<p>We request bank to remove the cap on the maximum Per Successful Financial Transaction Rate for Offsite ATMs permitted during the tenure of contract shall be Rs. 2 less than the prevailing interchange fee. If the difference between the increased price and prevailing Interchange fee is less than Rs. 2, then the per successful transaction rate will freeze (without revision) for the residual period of the contract and extension thereof. It will be revised only when the interchange fee is revised by RBI, subject to increased price shall always remain Rs. 02 less than RBI interchange fee.</p>	<p>Terms &amp; Conditions applicable as per RFP</p>
----	---------	-----	---	--	---



		<p>interchange fee. If the difference between the increased price and prevailing Interchange fee is less than Rs. 2, then the per successful transaction rate will freeze (without revision) for the residual period of the contract and extension thereof. It will be revised only when the interchange fee is revised by RBI, subject to increased price shall always remain Rs. 02 less than RBI interchange fee.</p>		
--	--	--	--	--

35	13.3.2.	CPI	<p>There would be a 2.5% cap on the annual increase in per Successful Transaction Rates. The Increment in payment would be directly correlated to the increase in the Index over 12 months period. For e.g., If the index value on 01st May 2023 is 120 which increases to 123 in 01st May 2024 thereby representing a 2.5% increase. The per Successful Transaction Rates would increase proportionately. However, if the index value increases beyond 2.5%, the increase in payment would be capped at 2.5%. The maximum Per Successful Financial Transaction Rate for Offsite ATMs permitted during the tenure of contract shall be Rs. 2 less than the prevailing</p>	<p>We request bank to increase the per transaction rate with a difference of Rs. 2 in the same proportion as rate increase by RBI. For e.g., if the rate increase is from Rs. Rs. 17 to Rs. 20 then the bank should proportionally increase the rate by 17.6%. This is a fair clause if the bank wants to restrict the rate gap between interchange and vendor by 2 Rs.</p>	<p>Terms &amp; Conditions applicable as per RFP</p>
----	---------	-----	---	---	---

		<p>interchange fee. If the difference between the increased price and prevailing Interchange fee is less than Rs. 2, then the per successful transaction rate will freeze (without revision) for the residual period of the contract and extension thereof. It will be revised only when the interchange fee is revised by RBI, subject to increased price shall always remain Rs. 02 less than RBI interchange fee.</p>		
--	--	--	--	--

36	13.3.4	PERIOD OF BID VALIDITY AND VALIDITY OF PRICE QUOTED IN REVERSE AUCTION (RA):	<p>13.3.4. The revised rates shall be applicable from 1st May subject to the fulfilment of Rollout Completion</p> <p>Conditions mentioned below: -</p> <p>13.3.4.1. All allotted base quota of ATMs to the respective successful bidders are cash live and available for Customer cash Transactions, and</p> <p>13.3.4.2. All SIS (Site implementation services) required for allotted base quota of ATMs to the respective successful bidders are complete, and</p> <p>13.3.4.3. All necessary compliances of RBI/IBA/NPCI/GOI/M HA etc. applicable for the base quota, attributable to the bidders, are complied with, and</p> <p>13.3.4.4. Bank's MVS, EPS any other software are installed</p>	Request bank to remove clause 13.3.4.4 as MVS, EPS or any other software would involve third party dependency	Terms & Conditions applicable as per RFP
----	--------	--	--	---	--

		and working on all allotted base quota ATMs to the respective successful bidders		
--	--	--	--	--

36	13.3.5	CPI	The first revised rates will be applicable only w.e.f. the upcoming 1st May, one year after the Bank declared the rollout completion date	We request bank to consider the change in clause to yearly rate increase to the machine installed during the year.	Terms & Conditions applicable as per RFP
36	13.3.5.2	PERIOD OF BID VALIDITY AND VALIDITY OF PRICE QUOTED IN REVERSE AUCTION (RA)	The first revised rates will be applicable only w.e.f. the 1st upcoming May, one year after the Bank declared the rollout completion date as above	We request the Bank to consider the timeline from the date of cash live for the last ATM under the project.	Terms & Conditions applicable as per RFP
41	19.1	AWARD CRITERIA AND AWARD OF CONTRACT	The Bidders will be selected as L1, L2, L3, L4, L5, L6 on the basis of the price discovered in the Reverse Auction, provided L2, L3, L4, L5, L6 matches Reverse Auction price of L1 (i.e., discovered "A" of the Indicative Commercial Bid).	We suggest Bank to modify this RFP clause on Techno-Commercial evaluation basis which will reflect the Competence of Bidders in terms of past uptime performance, compliances and financial position of the Bidder alongwith the commercials.	Terms & Conditions applicable as per RFP

41	19.1	AWARD CRITERIA AND AWARD OF CONTRACT	<p>Bank intends to allocate procurement of services as per mentioned quantities under this RFP among Maximum of Six (06) Successful Bidders (L1 to L6) through GeM Portal. The Bidders will be selected as L1, L2, L3, L4, L5, L6 on the basis of the price discovered in the Reverse Auction, provided L2, L3, L4, L5, L6 matches Reverse Auction price of L1 (i.e., discovered "A" of the Indicative Commercial Bid).</p>	<p>As per RFP clause, the gap between L4 and L5/L6 is huge (i.e. L1 - 25%, L2 - 23%, L3 - 21%, L4 - 19%, L5 - 6%, L6 - 6%) and disparate unlike the gap between L1-L4. L5 &amp; L6 count is extremely low..</p> <p>We request Bank to rationalize the gap in allocation between L4 and L5/L6.</p>	<p>Terms &amp; Conditions applicable as per RFP</p>
----	------	--------------------------------------	---	---	---

43	19.1.9	19.1.9	<p>Purchase Preference applicability in tenders where contract is to be awarded to multiple bidders:</p>	<p><b>Recommendations:</b></p> <p>The current Bidder classification based on Class I and Class II mentioned in this tender is not in alien with Make In India (MII) Policy.</p> <p>The MII define very clear that Class I has preference over Class II in any scenario, exact when L1 is class 2.</p> <p>We are requesting the Bank to follow the Indian Government Make in India according and rectify the existing awards mechanism defined in this tender.</p>	<p><b>CORRIGENDUM: (partially)</b></p> <p>All the following scenarios are indicative in nature only for the purpose of compliance of Public procurement (preference to Make in India) order issued by DPIIT dated 16.09.2020 and Manual for Procurement of Goods (Updated June 2022). <del>and</del> Bank reserves the right to modify the distribution % basing on the emergence of any new scenario <b>as per Make in India (MII) Guidelines. The Bank will ensure the same</b> and Bank decision in this regard will be binding to bidders: -</p>
----	--------	--------	--	---	--



43	19.1.9	AWARD CRITERIA AND AWARD OF CONTRACT	Purchase Preference applicability in tenders where contract is to be awarded to multiple bidders	<p>As per ATM OEM 1's Recommendations:</p> <p>The current Bidder classification based on Class I and Class II mentioned in this tender is not in alien with Make In India (MII) Policy.</p> <p>The MII define very clear that Class I has preference over Class II in any scenario, exact when L1 is class 2.</p> <p>We are requesting the Bank to follow the Indian Government Make in India according and rectify the existing awards mechanism defined in this tender.</p>	<p><b>CORRIGENDUM: (partially)</b></p> <p>All the following scenarios are indicative in nature only for the purpose of compliance of Public procurement (preference to Make in India) order issued by DPIIT dated 16.09.2020 and Manual for Procurement of Goods (Updated June 2022). <del>and</del> Bank reserves the right to modify the distribution % basing on the emergence of any new scenario <b>as per Make in India (MII) Guidelines. The Bank will ensure the same</b> and Bank decision in this regard will be binding to bidders: -</p>
----	--------	--------------------------------------	--	---	--

43	19.1.9	AWARD CRITERIA AND AWARD OF CONTRACT:	Purchase Preference applicability in tenders where contract is to be awarded to multiple bidders:	<p>Recommendations:</p> <p>The current Bidder classification based on Class I and Class II mentioned in this tender is not in alien with Make In India (MII)Policy.</p> <p>The MII define very clear that Class I has preference over Class II in any scenario, exact when L1 is class 2.</p> <p>We are requesting the Bank to follow the Indian Government Make in India according and rectify the existing awards mechanism defined in this tender.</p>	<p><b>CORRIGENDUM: (partially)</b></p> <p>All the following scenarios are indicative in nature only for the purpose of compliance of Public procurement (preference to Make in India) order issued by DPIIT dated 16.09.2020 and Manual for Procurement of Goods (Updated June 2022). <del>and</del> Bank reserves the right to modify the distribution % basing on the emergence of any new scenario <b>as per Make in India (MII) Guidelines. The Bank will ensure the same</b> and Bank decision in this regard will be binding to bidders: -</p>
----	--------	---------------------------------------	---	---	--

43	19.1.9		<p>Purchase Preference applicability in tenders where contract is to be awarded to multiple bidders:</p>	<p>Recommendations:</p> <p>The current Bidder classification based on Class I and Class II mentioned in this tender is not in alien with Make In India (MII)Policy.</p> <p>The MII define very clear that Class I has preference over Class II in any scenario, exact when L1 is class 2.</p> <p>We are requesting the Bank to follow the Indian Government Make in India according and rectify the existing awards mechanism defined in this tender.</p>	<p><b>CORRIGENDUM: (partially)</b></p> <p>All the following scenarios are indicative in nature only for the purpose of compliance of Public procurement (preference to Make in India) order issued by DPIIT dated 16.09.2020 and Manual for Procurement of Goods (Updated June 2022). <del>and</del> Bank reserves the right to modify the distribution % basing on the emergence of any new scenario <b>as per Make in India (MII) Guidelines. The Bank will ensure the same</b> and Bank decision in this regard will be binding to bidders: -</p>
----	--------	--	--	---	--

43	19.1.9		Purchase Preference applicability in tenders where contract is to be awarded to multiple bidders:	<p>Recommendations:</p> <p>The current Bidder classification based on Class I and Class II mentioned in this tender is not in alien with Make In India (MII) Policy.</p> <p>The MII define very clear that Class I has preference over Class II in any scenario, exact when L1 is class 2.</p> <p>We are requesting the Bank to follow the Indian Government Make in India according and rectify the existing awards mechanism defined in this tender.</p>	<p><b>CORRIGENDUM: (partially)</b>  All the following scenarios are indicative in nature only for the purpose of compliance of Public procurement (preference to Make in India) order issued by DPIIT dated 16.09.2020 and Manual for Procurement of Goods (Updated June 2022). <del>and</del> Bank reserves the right to modify the distribution % basing on the emergence of any new scenario <b>as per Make in India (MII) Guidelines. The Bank will ensure the same</b> and Bank decision in this regard will be binding to bidders: -</p>
50			SCENARIO -VI: 06 BIDDERS	<p>Request Bank to Clarify in case of the following scenerion what is the allocation.</p> <p>Where L1 and L5 are Class I local suppliers where as L2 L3 L4 L6 are Class II local suppliers</p>	<p><b>CORRIGENDUM: (partially)</b>  All the following scenarios are indicative in nature only for the purpose of compliance of Public procurement (preference to Make in India) order issued by DPIIT dated 16.09.2020 and Manual for Procurement of Goods (Updated June 2022). <del>and</del> Bank reserves the right to modify the distribution % basing on the emergence of any new scenario <b>as per Make in India (MII) Guidelines. The Bank will ensure the same</b> and Bank decision</p>

					in this regard will be binding to bidders: -
52		19.2.2	TCO shall be calculated considering 150 (one hundred fifty) Successful Financials Transactions @ discovered rate i.e., "A" as per price bid and 50 (fifty) Non-Financial transactions @ derived rate from "A" as per price bid i.e., "B" at Offsite ATMs.	We request the Bank to help with the current avg Successful Financial and Non Financial transaction AND Request the Bank to give a minimum transaction guarantee	Terms & Conditions applicable as per RFP

53	20	Powers to vary and omit work	No alterations, amendments, omissions, additions, suspensions or variations of the services (hereinafter referred to as variation) under the contract shall be made by the successful Bidder except as directed in writing by Bank. The Bank shall have full powers, subject to the provision herein after contained, from time to time during the execution of the contract, by notice in writing to instruct the successful Bidder to make any variation without prejudice to the contract. The finally selected Bidder shall carry out such variation and be bound by the same conditions as far as applicable as though the said variations occurred in the contract documents.	The right to amend or vary the agreement/contract shall vest with both the parties.	Terms & Conditions applicable as per RFP
----	----	------------------------------	---	---	--

		<p>If any, suggested variations would, in the opinion of the finally selected Bidder, if carried out, prevent him from fulfilling any of his obligations under the contract, he shall notify Bank thereof in writing with reasons for holding such opinion and Bank shall instruct the successful Bidder to make such other modified variation without prejudice to the contract. The finally selected Bidder shall carry out such variation and be bound by the same conditions as far as applicable as though the said variations occurred in the contract documents. If the Bank confirms its instructions, the successful Bidder's obligations shall be modified to such an extent as may be</p>		
--	--	--	--	--

		<p>mutually agreed, if such variation involves extra cost. Any agreed difference in cost occasioned by such variation shall be added to or deducted from the contract price as the case may be.</p>		
--	--	---	--	--



53	53.6	INDEMNITY	Neither Party shall be liable to the other for any special, indirect, incidental, consequential (including loss of profit or revenue), exemplary or punitive damages, whether in contract, tort or other theories of law, even if such Party has been advised of the possibility of such damages	Modify clause to - Bank will be liable to the vendor for any financial loss due to switch failure or any other technical failure occurring due to bank or other software vendor (e.g. MVS, OMS etc.) thereby impacting the machine performance and ability of the end-customer to do transactions	Terms & Conditions applicable as per RFP
53	19. AWARD CRITERIA AND AWARD OF CONTRACT:	AWARD CRITERIA AND AWARD OF CONTRACT:	19.2.8. Failure of the successful Bidder to comply with the requirements / 19.2.9. terms and conditions of this RFP shall constitute sufficient grounds for the annulment of the award and forfeiture of the EMD and/or BG.	Requested Changes : Bank shall not forfeit EMD and/or BG without its consent of Bidder.	Terms & Conditions applicable as per RFP

54	21	<p><b>WAIVER OF RIGHTS</b></p>	<p>Each Party agrees that any delay or omission on the part of the other Party to exercise any right, power or remedy under this RFP will not automatically operate as a waiver of such right, power or remedy or any other right, power or remedy and no waiver will be effective unless it is in writing and signed by the waiving Party. Further the waiver or the single or partial exercise of any right, power or remedy by either Party hereunder on one occasion will not be construed as a bar to a waiver of any successive or other right, power or remedy on any other occasion.</p>	<p>Unless the delay is due to no fault of the Party, or such party was unable to exercise any rights due to Force Majeure and/or any other circumstance out of their control, the rights or remedies available under this RFP shall not be waived</p>	<p>Terms &amp; Conditions applicable as per RFP</p>
----	----	--------------------------------	--	---	---

55	23	<b>BANK'S RIGHT TO ACCEPT ANY BID AND TO REJECT ANY OR ALL BIDS</b>	<p>The Bank reserves the right to accept or reject any Bid in part or in full or to cancel the bidding process and reject all Bids at any time prior to contract award as specified in Award Criteria and Award of Contract, without incurring any liability to the affected Bidder or Bidders or any obligation to inform the affected Bidder or Bidders of the grounds for the Bank's action.</p>	<p>We would request the Bank to amend the clause to include a timeline for a re-bid since there are business decisions based on this RFP and any cancellations post award of bid would lead to significant reputational as well as financial losses to the Bidders</p>	<p>Terms &amp; Conditions applicable as per RFP</p>
----	----	---	---	--	---

55

24

**PERFORMANCE BANK GUARANTEE AND BANK GUARANTEE:**

**PERFORMANCE BANK GUARANTEE AND BANK GUARANTEE:**  
24.1 Performance Bank Guarantee [PBG] shall be of the amount 08% (eight%) of the Total Cost of Ownership (TCO) based on the Final reverse auction price (which shall be calculated and advised by the Bank to Selected Bidder(s)) with validity period of 96 months.

The requirement of Performance Bank Guarantee of 8% of TCO for 96 months is very high. The Bank already has separate BG for cash for Rs 50000/ ATM and other penalty clauses in the RFP to protect its interests. The high BG of 8% will not only lead to extra financial cost for bidder and lead to higher pricing for the Bank but also significantly blocking liquidity of the bidders due to need for high margins to BG issuing Banks for such long tenures. Relaxation will also help attract more interested Bidders to participate in the RFP.

1) We request the Bank to consider the Performance Bank Guarantee/ Insurance Surety Bond at 3% as per the PSU RFP standards.

2) We request the Bank to consider the Performance Bank Guarantee/ Insurance Surety Bond at 3% of the Annual Contract Value renewed every year for the required period as per the existing contract terms.

**CORRIGENDUM:**

**PERFORMANCE BANK GUARANTEE AND BANK GUARANTEE:**  
24.1 Performance Bank Guarantee [PBG] shall be of the amount ~~08% (eight%)~~ **5(five)%** of the Total Cost of Ownership (TCO) based on the Final reverse auction price (which shall be calculated and advised by the Bank to Selected Bidder(s)) with validity period of 96 months.

55

24.1

**PERFORMANCE BANK GUARANTEE AND BANK GUARANTEE:**

**PERFORMANCE BANK GUARANTEE AND BANK GUARANTEE:** Performance Bank Guarantee [PBG] shall be of the amount 08% (eight%) of the Total Cost of Ownership (TCO) based on the Final reverse auction price (which shall be calculated and advised by the Bank to Selected Bidder(s)) with validity period of 96 months.

We request Bank to allow Insurance Security Bonds as an additional instrument for furnishing Performance Security as per the govt guidelines. As per 6.1.2 (i) in page 106 of the Manual for Procurement of Goods dated June 2022 by Dept of Expenditure, Procurement Policy Division, Ministry of Finance - Performance Security may be furnished in the form of Insurance Surety Bond. This is also as per Office Memorandum No.F.1/1/2022-PPD dated 02.02.2022 of Dept of Expenditure, Ministry of Finance which made amendments to General Financial Rules (GFR), 2017 regarding 'Bid Security' and 'Performance Security' to include Insurance Surety Bonds as Security Instrument. The Bank's rights under the Insurance Surety Bond will be akin to that in Bank Guarantee wherein Bank will be the beneficiary and Insurance company will be the Guarantor. Additional comfort can be provided to Bank from Insurance company directly.

**CORRIGENDUM:** Performance Bank Guarantee [PBG] shall be of the amount ~~08% (eight%)~~ **05(five)%** of the Total Cost of Ownership (TCO) based on the Final reverse auction price (which shall be calculated and advised by the Bank to Selected Bidder(s)) with validity period of 96 months.

55	24.1	<p>PERFORMANCE BANK GUARANTEE AND BANK GUARANTEE:</p>	<p>PERFORMANCE BANK GUARANTEE AND BANK GUARANTEE: Performance Bank Guarantee [PBG] shall be of the amount 08% (eight%) of the Total Cost of Ownership (TCO) based on the Final reverse auction price (which shall be calculated and advised by the Bank to Selected Bidder(s)) with validity period of 96 months.</p>	<p>We request Bank to refer to Office Memorandum Ref No. No. F. 1 1612023-PPD dated 23.05.2023 by Department of Expenditure, Procurement Policy Division, Ministry of Finance on Proportionality in Performance Security for multiyear service contracts which allows performance security to be released in proportion to the balance service period.</p> <p>We request Bank to enable this provision in the Performance Security condition as per govt guidelines.</p>	<p><b>CORRIGENDUM:</b> Performance Bank Guarantee [PBG] shall be of the amount <del>08% (eight%)</del> <b>05(five)%</b> of the Total Cost of Ownership (TCO) based on the Final reverse auction price (which shall be calculated and advised by the Bank to Selected Bidder(s)) with validity period of 96 months.</p>
----	------	---	---	--	--

55	24.2	<p>Bank, at its own discretion and option can extend contract period beyond 07 years for further up to 03 years, in one or more tranches. In such condition the existing Performance Bank Guarantee should be extended for the number of extended years + 1 year as advised by the Bank.</p>	<p>Bank, at its own discretion and option can extend contract period beyond 07 years for further up to 03 years, in one or more tranches. In such condition the existing Performance Bank Guarantee should be extended for the number of extended years + 1 year as advised by the Bank.</p>	<p>While Bank can keep this option, but, if Bank decides to go for extension, any such extension will happen on mutually agreed commercials.</p>	<p>Terms &amp; Conditions applicable as per RFP</p>
----	------	--	--	--	---

55	24.2	24. PERFORMANCE BANK GUARANTEE AND BANK GUARANTEE:	Bank, at its own discretion and option can extend contract period beyond 07 years for further up to 03 years, in one or more tranches. In such condition the existing Performance Bank Guarantee should be extended for the number of extended years + 1 year as advised by the Bank.	While Bank can keep this option, but, if Bank decides to go for extension, any such extension will happen on mutually agreed commercials.	Terms & Conditions applicable as per RFP
55	24.3	PERFORMANCE BANK GUARANTEE AND BANK GUARANTEE:	The PBG furnished hereunder should strictly be on the format at Appendix-H and is to be submitted within 30 days of receipt of formal communication by bank to finally selected bidders	Considering the quantum of PBG is high, we request Bank to give more time to Bidders to arrange the PBG. We request Bank to give upto 60 days of receipt of formal communication by bank to finally selected bidders	Terms & Conditions applicable as per RFP
55	24.3	PERFORMANCE BANK GUARANTEE AND BANK GUARANTEE:	The PBG furnished hereunder should strictly be on the format at Appendix-H and is to be submitted within 30 days of receipt of formal communication by	We would like to request the Bank to extend the timeline up to 60 days of receipt of PO by the bank.	Terms & Conditions applicable as per RFP



			bank to finally selected bidders		
55	23. BANK'S RIGHT TO ACCEPT ANY BID AND TO REJECT ANY OR ALL BIDS:	BANK'S RIGHT TO ACCEPT ANY BID AND TO REJECT ANY OR ALL BIDS:	The Bank reserves the right to accept or reject any Bid in part or in full or to cancel the bidding process and reject all Bids at any time prior to contract award as specified in Award Criteria and Award of Contract, without incurring any liability to the affected Bidder or Bidders or any obligation to inform the affected Bidder or Bidders of the grounds for the Bank's action.	Requested Changes : Bank shall not reject Bid without its consent of Bidder.	Terms & Conditions applicable as per RFP

55	24. PERFORMANCE BANK GUARANTEE AND BANK GUARANTEE:	PERFORMANCE BANK GUARANTEE AND BANK GUARANTEE:	24.8 If Service Provider fails to submit Performance Bank Guarantee / Bank Guarantee within the stipulated time schedule as specified in this Agreement , the Bank may without prejudice to its other remedies under the RFP / Agreement, and unless otherwise extension of time is agreed upon without the application of liquidated damages, deduct from the project cost, as liquidated damages a sum equivalent to 0.5% of Total Project Cost allocated to bidder for delay of each week or part thereof maximum up to 5% of Total Project Cost allocated to bidder. Once the maximum deduction is reached, the Bank may consider	Requested Changes : Bank to provide a cure period of 7 days before taking any action.	Terms & Conditions applicable as per RFP
----	--	--	---	---	--

		termination of the Agreement.		
--	--	-------------------------------	--	--

56	24.7	PERFORMANCE BANK GUARANTEE AND BANK GUARANTEE	<p>The Successful bidder shall submit to the respective Circles / Local Head Office (LHO) a Bank Guarantee for the term of 96 months @ Rs. 50,000/- per endpoint in the specified format for securing the obligations in respect of cash loss in the number of endpoints allotted for cash services in each Circles. For any further addition of endpoints allotted to the Vendor during the currency of the agreement, additional Bank Guarantee on the same terms and conditions for added number of endpoints shall have to be provided by the Vendor to the Circles. Vendor should submit the Bank guarantee to the respective Circles Anytime Channels within 15 days from</p>	<p>Since there already is a Bank Guarantee of ₹ 50,000/- per end point and would request the Bank to consider this as an overall Performance Bank Guarantee</p>	<p>Terms &amp; Conditions applicable as per RFP</p>
----	------	---	---	---	---

		<p>the issue of PO by Circle. Machines will be made cash live only after the receiving the Bank Guarantee. In case of non-submission of Bank Guarantee within timeline, a penalty of Rs.5,000/- per day per machine will be charged to the vendor from the 16th day onwards till the same is submitted. In the event of failure on the part of the vendor to pay for cash losses as per the terms and conditions, the Bank shall be entitled to invoke the guarantee.</p>		
--	--	---	--	--

56	24.7	PERFORMANCE BANK GUARANTEE AND BANK GUARANTEE:	The Successful bidder shall submit to the respective Circles / Local Head Office (LHO) a Bank Guarantee for the term of 96 months @ Rs. 50,000/- per endpoint in the specified format for securing the obligations in respect of cash loss in the number of endpoints allotted for cash services in each Circles	Bank has already stipulated high Performance Security of 3% of TCO. Moreover bidder will be taking adequate insurance cover for the cash in ATM and cash in transit for any cash losses. In addition to that, Bank already has right to deduct the cash loss from vendor payments. Hence stipulating additional BG of Rs 50000 per endpoint would create additional financial burden for bidders. We request Bank to reduce this to Rs 10000 per endpoint. Insurance Surety Bond should also be allowed in lieu of BG as in case of EMD and Performance Security.	Terms & Conditions applicable as per RFP
----	------	--	--	---	--

56	25.2  25.5	SERVICES:	<p>Service Provider shall provide and implement patches/ upgrades/ updates for products (Software / Firmware/ OS / hardware / software / Operating System / Middleware etc.) as and when released by the Vendor / OEM or as per requirements <u>of the Bank without any additional cost.</u></p> <p>Service provider should bring to notice of the Bank all releases/ version changes in this regard.</p> <p>All product updates, upgrades &amp; patches shall be provided by Service Provider <u>free of cost during Contract period</u> and extension thereof.</p>	Bidder would like to clarify that any additional costs involved in complying with this requirement, the cost will be borne by the Bank.	Terms & Conditions applicable as per RFP
----	------------------	-----------	--	---	--

56	24.7	<p>The Successful bidder shall submit to the respective Circles / Local Head Office (LHO) a Bank Guarantee for the term of 96 months @ Rs. 50,000/- per endpoint in the specified format for securing the obligations in respect of cash loss in the number of endpoints allotted for cash services in each Circles.</p>	<p>The bidder is already issuing a PBG for the TCO which already includes Cash management. Then why a separate PBG for Cash. Also the PBG should be annual and renewable annually as per the services availed by LHO</p>	<p>Terms &amp; Conditions applicable as per RFP</p>
----	------	--	--	---



57	25.2	25. SERVICES:	<p>Service Provider shall provide and implement patches/ upgrades/ updates for products (Software / Firmware/ OS / hardware / software / Operating System / Middleware etc.) as and when released by the Vendor / OEM or as per requirements of the Bank without any additional cost. Service provider should bring to notice of the Bank all releases/ version changes in this regard</p>	<p>We request Bank to modify this clause, any future upgrades of hardware &amp; software will be on mutually agreed cost.</p>	<p>Terms &amp; Conditions applicable as per RFP</p>
----	------	---------------	--	---	---

57	25.2	<p>Service Provider shall provide and implement patches/ upgrades/ updates for products (Software / Firmware/ OS / hardware / software / Operating System / Middleware etc.) as and when released by the Vendor / OEM or as per requirements of the Bank without any additional cost. Service provider should bring to notice of the Bank all releases/ version changes in this regard</p>	<p>Service Provider shall provide and implement patches/ upgrades/ updates for products (Software / Firmware/ OS / hardware / software / Operating System / Middleware etc.) as and when released by the Vendor / OEM or as per requirements of the Bank without any additional cost. Service provider should bring to notice of the Bank all releases/ version changes in this regard</p>	<p>We request Bank to modify this clause, any future upgrades of hardware &amp; software will be on mutually agreed cost.</p>	<p>Terms &amp; Conditions applicable as per RFP</p>
----	------	--	--	---	---

57	25.2	Services	Service Provider shall provide and implement patches/ upgrades/ updates for products (Software / Firmware/ OS / hardware / software / Operating System / Middleware etc.) as and when released by the Vendor / OEM or as per requirements of the Bank without any additional cost	Any upgrade to be done at mutually agreed cost between the parties	Terms & Conditions applicable as per RFP
----	------	----------	---	--	--

57	25.22	Services	<p>The ownership of the software / firmware / operating system license and the hardware shall be that of the Bank from the date of delivery of the same to the Bank. In other words, wherever the ownership of the licenses/hardware is indicated, the name "State Bank of India" must appear to indicate that the Bank is the perpetual owner of the hardware/operating software /firmware / operating system, etc. associated with the hardware. Evidence in this regard must be submitted before the payment is released. License certificate to be provided by Vendor.</p>	<p>Under an OPEX model, it is important to state the ownership of the ATMs and the related assets will remain with the Service Provider. Request Bank to delete this clause and instead include below provision:</p> <p>"All right, title and interest in all Service Provider owned ATMs and related assets will at all times remain with Service Provider. The Bank will only have the right to use the Service Provider owned ATMs in accordance with the terms of this Agreement which will be subject to Bank's compliance with Bank's obligations under the terms of this Agreement. The Service Provider owned ATMs will remain the personal property of Service Provider even if physically attached to real property. At Bank's expense, Bank will protect and defend the title and interest of Service Provider and keep the Service Provider owned ATMs free of all claims and liens other than claims and liens created by or arising through Service Provider. Bank agree to</p>	<p><b>CORRIGENDUM:</b>  <del>The ownership of the software / firmware / operating system license and the hardware shall be that of the Bank from the date of delivery of the same to the Bank. In other words, wherever the ownership of the licenses/hardware is indicated, the name "State Bank of India" must appear to indicate that the Bank is the perpetual owner of the hardware/operating software /firmware / operating system, etc. associated with the hardware</del></p>
----	-------	----------	--	---	---

			<p>take such action, at Bank sole expense, as Service Provider reasonably requests, to prevent any third party from acquiring any interest in the Service Provider owned ATMs. The Bank will execute and deliver to Service Provider such other documents and provide such information as Service Provider may reasonably deem necessary to evidence or protect Service Provider's interests in the Service Provider owned ATMs and Service Provider's rights under this Agreement. "</p>	
--	--	--	---	--

57	25.3	25. SERVICES:	<p>Service Provider shall obtain a written permission from the Bank before applying any of the patches / upgrades / updates. Bidder must support older versions of the hardware / software / Operating System / OS / firmware / Middleware etc. in case the Bank chooses not to upgrade to latest version.</p>	<p>Support for the older version will only available till it will provided by the respective OEM of Software and Hardware. We request bank to consider the modification in the caluse.</p>	<p>Terms &amp; Conditions applicable as per RFP</p>
----	------	---------------	--	--	---

57	25.3	<p>Service Provider shall obtain a written permission from the Bank before applying any of the patches / upgrades / updates. Bidder must support older versions of the hardware / software / Operating System / OS / firmware / Middleware etc. in case the Bank chooses not to upgrade to latest version.</p>	<p>Service Provider shall obtain a written permission from the Bank before applying any of the patches / upgrades / updates. Bidder must support older versions of the hardware / software / Operating System / OS / firmware / Middleware etc. in case the Bank chooses not to upgrade to latest version.</p>	<p>Support for the older version will only available till it will provided by the respective OEM of Software and Hardware. We request bank to consider the modification in the caluse.</p>	<p>Terms &amp; Conditions applicable as per RFP</p>
----	------	--	--	--	---

57	25.3	Services	Service Provider shall obtain a written permission from the Bank before applying any of the patches / upgrades / updates. Bidder must support older versions of the hardware / software / Operating System / OS / firmware / Middleware etc. in case the Bank chooses not to upgrade to latest version.	As per the Servicing and Maintenance contract which the Bank and Bidder shall enter into, procuring a prior written permission from the bank before any upgrade or any patch services may not always be possible. Hence, the upgrades, shall be as mutually agreed between the parties	Terms & Conditions applicable as per RFP
57	25.3	SERVICES	Service Provider shall obtain a written permission from the Bank before applying any of the patches / upgrades / updates. Bidder must support older versions of the hardware / software / Operating System / OS / firmware / Middleware etc. in case the Bank chooses not to upgrade to latest version	The machines will deliver as per standrad mentioned in RFP any future upgrades, hardware / software / Operating System / OS / firmware / Middleware recommended by the Bank or regulators shall be on mutial agreed cost.	Terms & Conditions applicable as per RFP



57	25.5	25.5	All product updates, upgrades & patches shall be provided by Service Provider free of cost during Contract period and extension thereof.	Any upgrade that are required due to change in compliance standards or any new requirement cannot be envisaged as on date and will require to discussed and mutually agreed at an incremental price.	Terms & Conditions applicable as per RFP
57	25.5	Services	All product updates, upgrades & patches shall be provided by Service Provider free of cost during Contract period and extension thereof.	Any upgrade that are required due to change in compliance standards or any new requirement cannot be envisaged as on date and will require to discussed and mutually agreed at an incremental price.	Terms & Conditions applicable as per RFP
57	25.5	Services	All product updates, upgrades & patches shall be provided by Service Provider free of cost during Contract period and extension thereof	Any upgrade to be done at mutually agreed cost between the parties	Terms & Conditions applicable as per RFP
57	25.5	SERVICES	All product updates, upgrades & patches shall be provided by Service Provider free of cost during Contract period and extension thereof.	As per ATM OEM 2 - Any upgrade that are required due to change in compliance standards or any new requirement cannot be envisaged as on date and we request the Bank for its mutual discussion for an agreed incremental price	Terms & Conditions applicable as per RFP

57	25.5	SERVICES	All product updates, upgrades & patches shall be provided by Service Provider free of cost during Contract period and extension thereof.	The machines will deliver as per standrad mentioned in RFP any future upgrades recommended by the Bank or regulators shall be on mutual agreed cost.	Terms & Conditions applicable as per RFP
57	57	25.5	All product updates, upgrades & patches shall be provided by Service Provider free of cost during Contract period and extension thereof.	Any upgrade that are required due to change in compliance standards or any new requirement cannot be envisaged as on date and will require to discussed and mutually agreed at an incremental price.	Terms & Conditions applicable as per RFP
57		25.5	All product updates, upgrades & patches shall be provided by Service Provider free of cost during Contract period and extension thereof.	Any upgrade that are required due to change in compliance standards or any new requirement cannot be envisaged as on date and will require to discussed and mutually agreed at an incremental price.	Terms & Conditions applicable as per RFP
58		25.9	ATS / AMC would be on-site and comprehensive in nature and must have back-to-back support from the OEM. Service Provider shall warrant products against defects arising out of faulty design	Bank to Clarify on-site ATS . What is the bidder to provide	Terms & Conditions applicable as per RFP

		etc. during the support period.		
--	--	---------------------------------	--	--

59	25.22	25.22	<p>The ownership of the software / firmware / operating system license and the hardware shall be that of the Bank from the date of delivery of the same to the Bank. In other words, wherever the ownership of the licenses/hardware is indicated, the name "State Bank of India" must appear to indicate that the Bank is the perpetual owner of the hardware/operating software /firmware / operating system, etc. associated with the hardware. Evidence in this regard must be submitted before the payment is released. License certificate to be provided by Vendor.</p>	<p>The Bank is just availing the services and is not buying the any Equipment. So the ownership cannot be transferred to the Bank.</p>	<p><b>CORRIGENDUM:</b>  <del>The ownership of the software / firmware / operating system license and the hardware shall be that of the Bank from the date of delivery of the same to the Bank. In other words, wherever the ownership of the licenses/hardware is indicated, the name "State Bank of India" must appear to indicate that the Bank is the perpetual owner of the hardware/operating software /firmware / operating system, etc. associated with the hardware</del></p>
----	-------	-------	--	--	---

59	25.22	25.22	<p>The ownership of the software / firmware / operating system license and the hardware shall be that of the Bank from the date of delivery of the same to the Bank. In other words, wherever the ownership of the licenses/hardware is indicated, the name "State Bank of India" must appear to indicate that the Bank is the perpetual owner of the hardware/operating software /firmware / operating system, etc. associated with the hardware. Evidence in this regard must be submitted before the payment is released. License certificate to be provided by Vendor.</p>	<p>The Bank is just availing the services and is not buying the any Equipment. So the ownership cannot be transferred to the Bank.</p>	<p><b>CORRIGENDUM:</b>  <del>The ownership of the software / firmware / operating system license and the hardware shall be that of the Bank from the date of delivery of the same to the Bank. In other words, wherever the ownership of the licenses/hardware is indicated, the name "State Bank of India" must appear to indicate that the Bank is the perpetual owner of the hardware/operating software /firmware / operating system, etc. associated with the hardware</del></p>
----	-------	-------	--	--	---

59	25.22	25.22	<p>The ownership of the software / firmware / operating system license and the hardware shall be that of the Bank from the date of delivery of the same to the Bank. In other words, wherever the ownership of the licenses/hardware is indicated, the name "State Bank of India" must appear to indicate that the Bank is the perpetual owner of the hardware/operating software /firmware / operating system, etc. associated with the hardware. Evidence in this regard must be submitted before the payment is released. License certificate to be provided by Vendor.</p>	<p>The Bank is just availing the services and is not buying the any Equipment. So the ownership cannot be transferred to the Bank.</p>	<p><b>CORRIGENDUM:</b>  <del>The ownership of the software / firmware / operating system license and the hardware shall be that of the Bank from the date of delivery of the same to the Bank. In other words, wherever the ownership of the licenses/hardware is indicated, the name "State Bank of India" must appear to indicate that the Bank is the perpetual owner of the hardware/operating software /firmware / operating system, etc. associated with the hardware</del></p>
----	-------	-------	--	--	---

59	25.22	25. SERVICES:	<p>The ownership of the software / firmware / operating system license and the hardware shall be that of the Bank from the date of delivery of the same to the Bank. In other words, wherever the ownership of the licenses/hardware is indicated, the name "State Bank of India" must appear to indicate that the Bank is the perpetual owner of the hardware/operating software /firmware / operating system, etc. associated with the hardware</p>	<p>This being a TOM RFP, ownership of hardware and associated software will remain with Bidder. In any case, in associated software( like XFS, driver), user only gets the license to use the same. We request Bank to modify the requested change in the clause.</p>	<p><b>CORRIGENDUM:</b>  <del>The ownership of the software / firmware / operating system license and the hardware shall be that of the Bank from the date of delivery of the same to the Bank. In other words, wherever the ownership of the licenses/hardware is indicated, the name "State Bank of India" must appear to indicate that the Bank is the perpetual owner of the hardware/operating software /firmware / operating system, etc. associated with the hardware</del></p>
----	-------	---------------	---	---	---

59	25.22	Services	<p>The ownership of the software/firmware license and the hardware shall be that of the Bank from the date of delivery of the same to the Bank. In other words, wherever the ownership of the licenses/hardware is indicated, the name "State Bank of India" must appear to indicate that the Bank is the perpetual owner of the hardware/operating software/firmware, etc. associated with the hardware. Evidence in this regard must be submitted before the payment is released.</p>	<p>The Software's procured by Successful bidder shall be limited for the period of services, which shall expiry upon completion of term of services to the Bank. In view of this request Bank to revise the said clause as ownership shall always be with software / firmware company.</p>	<p><b>CORRIGENDUM:</b>  <del>The ownership of the software / firmware / operating system license and the hardware shall be that of the Bank from the date of delivery of the same to the Bank. In other words, wherever the ownership of the licenses/hardware is indicated, the name "State Bank of India" must appear to indicate that the Bank is the perpetual owner of the hardware/operating software /firmware / operating system, etc. associated with the hardware</del></p>
----	-------	----------	---	--	---



59	25.22	Services	<p>The ownership of the software / firmware / operating system license and the hardware shall be that of the Bank from the date of delivery of the same to the Bank. In other words, wherever the ownership of the licenses/hardware is indicated, the name "State Bank of India" must appear to indicate that the Bank is the perpetual owner of the hardware/operating software /firmware / operating system, etc. associated with the hardware. Evidence in this regard must be submitted before the payment is released. License certificate to be provided by Vendor.</p>	<p>The Bank is just availing the services and is not buying the any Equipment. So the ownership cannot be transferred to the Bank.</p>	<p><b>CORRIGENDUM:</b>  <del>The ownership of the software / firmware / operating system license and the hardware shall be that of the Bank from the date of delivery of the same to the Bank. In other words, wherever the ownership of the licenses/hardware is indicated, the name "State Bank of India" must appear to indicate that the Bank is the perpetual owner of the hardware/operating software /firmware / operating system, etc. associated with the hardware</del></p>
----	-------	----------	--	--	---

59	25.22	SERVICES	<p>The ownership of the software / firmware / operating system license and the hardware shall be that of the Bank from the date of delivery of the same to the Bank. In other words, wherever the ownership of the licenses/hardware is indicated, the name "State Bank of India" must appear to indicate that the Bank is the perpetual owner of the hardware/operating software /firmware / operating system, etc. associated with the hardware. Evidence in this regard must be submitted before the payment is released. License certificate to be provided by Vendor</p>	<p>We request further clarity on this point. Since the Bank is just availing the services and is not buying any equipment. Accordingly, the ownership cannot be transferred to the Bank.</p>	<p><b>CORRIGENDUM:</b> <del>The ownership of the software / firmware / operating system license and the hardware shall be that of the Bank from the date of delivery of the same to the Bank. In other words, wherever the ownership of the licenses/hardware is indicated, the name "State Bank of India" must appear to indicate that the Bank is the perpetual owner of the hardware/operating software /firmware / operating system, etc. associated with the hardware</del></p>
----	-------	----------	---	--	--

59

25.22

The ownership of the software / firmware / operating system license and the hardware shall be that of the Bank from the date of delivery of the same to the Bank. In other words, wherever the ownership of the licenses/hardware is indicated, the name "State Bank of India" must appear to indicate that the Bank is the perpetual owner of the hardware/operating software /firmware / operating system, etc. associated with the hardware

The ownership of the software / firmware / operating system license and the hardware shall be that of the Bank from the date of delivery of the same to the Bank. In other words, wherever the ownership of the licenses/hardware is indicated, the name "State Bank of India" must appear to indicate that the Bank is the perpetual owner of the hardware/operating software /firmware / operating system, etc. associated with the hardware

This being a TOM RFP, ownership of hardware and associated software will remain with Bidder. In any case, in associated software( like XFS, driver), user only gets the license to use the same. We request Bank to modify the requested change in the clause.

**CORRIGENDUM:**  
~~The ownership of the software / firmware / operating system license and the hardware shall be that of the Bank from the date of delivery of the same to the Bank. In other words, wherever the ownership of the licenses/hardware is indicated, the name "State Bank of India" must appear to indicate that the Bank is the perpetual owner of the hardware/operating software /firmware / operating system, etc. associated with the hardware~~

60	28.1	Right to Audit	<p>The Selected Bidder (Service Provider) shall be subject to annual audit by internal / external Auditors appointed by the Bank / inspecting official from the Reserve Bank of India or any regulatory authority, covering the risk parameters finalized by the Bank / such auditors in the areas of products (IT hardware / Software) and services etc. provided to the Bank and Service Provider is required to submit such certification by such Auditors to the Bank. S</p>	<p>We suggest that the right to Audit needs to be only after prior intimation of 15 days to the Bidder.</p>	<p>Terms &amp; Conditions applicable as per RFP</p>
----	------	----------------	--	---	---

60	28.1	RIGHT TO AUDIT:	<p>.....Except for the audit done by Reserve Bank of India or any statutory / regulatory authority, the Bank shall provide reasonable notice of <u>not less than One day to Service Provider</u> before such audit and same shall be conducted during normal business hours. Bank also reserves the right for conducting surprise audit. Bidder / vendor shall have obligation to comply with all the recommendations /close all the vulnerabilities reported in the various security review, IS Audit, UAT etc conducted by the Bank, regulators, Bank appointed third party at various stages during the contact period without any additional cost the Bank.”</p>	<p>The Bidder request the Bank to provide advance notice of not less than 7 (seven) days for any kind of audit including by RBI and regulatory authority.</p>	<p>Terms &amp; Conditions applicable as per RFP</p>
----	------	-----------------	--	---	---

60	26. PENALTIES:	PENALTIES:	-	Requested Changes : Bank to provide a cure period in the circumstances mentioned in the clause before levying penalty on the Bidder. Further under no circumstance shall bank levy the penalty without the consent of the Bidder.	Terms & Conditions applicable as per RFP
61	29.1	Subcontracting	As per scope of the RFP, sub-contracting of total scope of work is restricted. However, If the Bidder wishes to sub-contract any part of scope of work, it will have to obtain specific written permission from the Bank before subcontracting any work to subcontractors. Bank at its own discretion may permit, deny and review the same. The Bank may at any time during the contract may cancel the permission given for the subcontracting vendor	Request Bank to amend the clause as  If the Bidder wishes to sub-contract any part of scope of work, it will have to inform the Bank before subcontracting any work to subcontractors. Bank at its own discretion may permit, deny and review the same. The Bank may at any time during the contract may cancel the permission given for the subcontracting vendor	Terms & Conditions applicable as per RFP

61	29.2		<p>In case subcontracting is permitted by the Bank, the Successful bidder will be responsible for all the sub-contracted services provided to the Bank regardless of which entity is conducting the operations. The Successful bidder is also responsible for ensuring that the sub-contractor complies with all GoI / security / statutory / Bank / RBI / MHA guidelines / local administration / Labour Laws etc., requirements of this RFP / SLA of Bank with the Successful Bidder. The Bank can obtain independent audit report for the same. Bidder shall provide subcontracting details along with the copy of the executed Service Level Agreement (SLA) immediately (at least 15 days before</p>	<p>Majority of the services at ATM are outsourced by us. Do we need to provide Agreement copies of all our vendors? These are confidential internal documents with restricted circulation as mandated by policy.</p>	<p>Terms &amp; Conditions applicable as per RFP</p>
----	------	--	---	--	---

		commencement of that subcontracting service) to the Bank and if require, Bank may evaluate the same.		
--	--	--	--	--



61	29.5	SUB-CONTRACTING	<p>In case of any requirement, Bank or its officials shall have right to directly contact / follow-up / instruct to sub-contractor of the Vendor, and such sub-contractor(s) shall respond to bank and follow Bank's such instructions and shall take action accordingly. Vendor shall take care of such clause in subsequent agreement with Sub-contractor(s), if any and shall instruct the same to its sub-contractor(s).</p>	<p>Bidder shall be responsible for managing the subcontractor and any of Bank's requirements shall be communicated to the Bidder</p>	<p>Terms &amp; Conditions applicable as per RFP</p>
----	------	-----------------	--	--	---

61	<p>29.1</p> <p>29.2</p>	SUB-CONTRACTING:	<p>29.1 As per scope of the RFP, sub-contracting of total scope of work is restricted. However, If the Bidder wishes to sub-contract any part of scope of work, it will have to obtain specific written permission from the Bank before subcontracting any work to subcontractors. Bank at its own discretion may permit, deny and review the same. The Bank may at any time during the contract may cancel the permission given for the subcontracting vendor.</p> <p>29.2. In case subcontracting is permitted by the Bank, <u>the Successful bidder will be responsible for all the sub-contracted services provided to the Bank regardless of</u></p>	<p>Bidder will enter into the agreement with subcontractors in line with the scope of service of this RFP and in case of any violation or breach by the subcontractor, the Bidder will be liable. Hence, the Bidder requests relaxation on submission of SLA executed with its sub-contractor.</p>	<p>Terms &amp; Conditions applicable as per RFP</p>
----	-------------------------	------------------	---	--	---

which entity is conducting the operations. The Successful bidder is also responsible for ensuring that the sub-contractor complies with all GoI / security / statutory / Bank / RBI / MHA guidelines / local administration / Labour Laws etc., requirements of this RFP / SLA of Bank with the Successful Bidder. The Bank can obtain independent audit report for the same. Bidder shall provide subcontracting details along with the copy of the executed Service Level Agreement (SLA) immediately (at least 15 days before commencement of that subcontracting service) to the Bank and if require, Bank may evaluate the same.

62	30.1	Validity of Agreement	30.1. The Agreement / SLA will be valid for the period of Seven (7) years which can be extended upto 10 years (i.e., upto another three years in one or more tranches after base 7 years period), solely at the discretion of the Bank. The Bank reserves the right to terminate the Agreement as per the terms of RFP / SLA.	The renewal of the contract should be mutual including the right of termination.	Terms & Conditions applicable as per RFP
62	30.2	VALIDITY OF AGREEMENT	The Machine Site, for all practical purposes, belongs to the Bank. Service Provider will, therefore, not transfer / sell / surrender / vacate the Site or / and enter into any contract / order / agreement with any other Bank / entity for the Site without Bank's permission. The Bank will also have the first right of refusal for the Site on termination / expiry of SLA	The offsites will be leased and accordingly, the legal rights are with the Shop Owners. Neither the Bank, nor the bidder, will have any rights to Sell/ Transfer over these site. The bidder can only facilitate transfer on mutually agreed terms, incase a situation arises	<b>CORRIGENDUM:</b> <del>The Machine Site, for all practical purposes, belongs to the Bank.</del> Service Provider will, <del>therefore,</del> not transfer / sell / surrender / vacate the Site or / and enter into any contract / order / agreement with any other Bank / entity for the Site without Bank's permission. The Bank will also have the first right of refusal for the Site on termination / expiry of SLA

62	31.1	Limitation of liability	The maximum aggregate liability of Service Provider, subject to clause 31.3, in respect of any claims, losses, costs or damages arising out of or in connection with this RFP / Agreement shall not exceed the total Project Cost.	The maximum aggregate liability upto total Project Cost is unreasonably high since the vendor may not have even earned that much amount under the project if this is triggered in middle of the contract period. We request Bank to consider the following modification: The liability of the Vendor under this Clause during the 1st year of contract shall be limited to the total amount of fees payable by the Bank under the Contract during the 1st Year and from 2nd year onwards, the liability of the Vendor shall be limited to the aggregate amount of fees paid to the Vendor by the bank during the entire Term of this Contract.	Terms & Conditions applicable as per RFP
62	31 and 53.7	Limiation of Liability	31.1. The maximum aggregate liability of Service Provider, subject to clause 31.3, in respect of any claims, losses, costs or damages arising out of or in connection with this RFP / Agreement shall not exceed the total Project Cost.	Project cost is not mentioned. There is an unlimited liability. We suggest to cap the liability. Further, Service Provider should only be liable for actual and proven losses incurred by the Bank which are attributable to Service Provider and not otherwise.	Terms & Conditions applicable as per RFP

62	<p>31.1</p> <p>31.2</p> <p>31.3.4</p> <p>53.7</p>	<p>LIMITATION OF LIABILITY:</p>	<p>The maximum aggregate liability of Service Provider, subject to clause 31.3, in respect of any claims, losses, costs or damages arising out of or in connection with this RFP / Agreement shall not exceed the total <u>Project Cost</u>.</p> <p>Under no circumstances shall either Party be liable for any indirect, consequential or incidental losses, damages or claims including loss of profit, loss of business or revenue. Service Provider will be liable for any losses incurred by the Bank which are attributable to Service Provider.</p> <p>Regulatory or statutory fines / penalty imposed by a Government or Regulatory</p>	<p>Bidder requests the Bank to reduce the maximum liability limit as 6 months of contract value.</p> <p>Bidder clarifies that Bidder will be liable for present requirements only. In case any future requirements arise due to any regulatory changes, shall be subject to mutual agreement between the parties. In this scenario, in case of any delay due to non-agreement between the parties on commercial, Bidder will not be liable.</p> <p>Limitation of liability clause is coming in two places. Hence, Bidder would discuss with Bank to agree on Limitation of liability clause.</p>	<p>Terms &amp; Conditions applicable as per RFP</p>
----	---	---------------------------------	---	--	---

agency(ies) for non-compliance of statutory or regulatory guidelines applicable to the Bank due to inaction on the part of vendor, provided such guidelines were brought to the notice of service provider. The regulatory and statutory Penalty / fines will be recovered from the vendor for the reasons attributable to the vendor under the services provided by the vendor to the Bank under the project.

**Limitation of Liability:**  
The total cumulative liability of the vendor arising from or relating to this Agreement shall not exceed the total amount payable to the Vendor by the Bank for the contract period. Provided

		<p>however, this limitation shall not apply to any liability or damages arising from (a) willful misconduct of the Vendor; (b) indemnification against third party claims for infringement; (c) breach of confidentiality obligations; (d) loss of Bank's Cash held in ATM / CD, in Transit and / or in Vault held by the Vendor or any agency engaged by the Vendor.</p>		
--	--	---	--	--



63	32  34.7	<p><b>CONFIDENTIALITY:</b></p> <p><b>SERVICE PROVIDER'S OBLIGATIONS:</b></p>	<p><b>32.1 Confidentiality obligation shall be as per Non-disclosure agreement placed as Appendix-K and / or SLA to this RFP.</b></p> <p><b>32.2 Bidder acknowledges and agrees that all tangible and intangible information obtained, developed or disclosed including all documents, contract, purchase order to be issued, data papers and statements and trade secret of the Bank relating to its business practices and their competitive position in the market place provided to the selected Bidder by the Bank in connection with the performance of obligations of Bidder under the purchase order to be issued, in part or complete shall be considered to be confidential and</b></p>	<p><b>Bidder clarifies that the proposal to be submitted by the Bidder would contain confidential and proprietary information of the Bidder and the Bidder will share the confidential information with the Bank for providing the services. Hence, the Bidder requests the Bank to make this Confidentiality clause and NDA on mutual.</b></p>	<p><b>Terms &amp; Conditions applicable as per RFP</b></p>
----	----------------	--	---	---	--

proprietary information ("Confidential Information") and shall not be disclosed to any third party/published without the written approval of the Bank.

**32.3 The Confidential Information will be safeguarded, and Bidder will take all the necessary action to protect it against misuse, loss, destruction, alterations, or deletions thereof. In the event of a breach or threatened breach by Bidder of this section, monetary damages may not be an adequate remedy; therefore, Bank shall be entitled to injunctive relief to restrain Bidder from any such breach, threatened or actual.**

**32.4 Any document, other than the Contract itself, shall**

remain the property of the Bank and shall be returned (in all copies) to the Bank on completion of the Vendor's performance under the Contract, if so, required by the Bank.

**32.5 Bidder** acknowledges and agrees for data and application privacy and confidentiality during contract period as per Bank norms.

Service Provider shall treat as confidential all data and information about the Bank, obtained in the process of executing its responsibilities, in strict confidence and will not reveal such information to any other party without prior written approval of the Bank as explained under 'Non-Disclosure Agreement' in

		Appendix-K of this RFP.		
--	--	-------------------------	--	--

63	32. CONFIDENTIALITY:	CONFIDENTIALITY:	-	Requested Changes : This clause should be kept mutual.	Terms & Conditions applicable as per RFP
64	33	Delay in Service Provider's performance	33.3. Any delay in performing the obligation/ defect in performance by Service Provider may result in imposition of penalty, liquidated damages, invocation of PBG / Bank Guarantee and / or termination of Contract (as laid down elsewhere in this RFP document).	This clause should be waived off as it may cause revenue losses to the bidder. Additionally, the Bank has a right to terminate the contract in the event of such delay.	Terms & Conditions applicable as per RFP
64	33. DELAY IN SERVICE PROVIDER'S PERFORMANCE:	DELAY IN SERVICE PROVIDER'S PERFORMANCE:	33.3. Any delay in performing the obligation/ defect in performance by Service Provider may result in imposition of penalty, liquidated damages, invocation of PBG / Bank Guarantee and / or termination of Contract (as laid down elsewhere in this RFP document).	Requested Changes : The Bidder is liable for any claim, demand, losses, liabilities or expenses of any nature and kind whatsoever which are directly attributable to it and not otherwise.	Terms & Conditions applicable as per RFP

64	34. SERVICE PROVIDER'S OBLIGATIONS:	SERVICE PROVIDER'S OBLIGATIONS:	34.4. Service Provider will abide by the job safety measures prevalent in India and will free the Bank from all demands or responsibilities arising from accidents or loss of life, the cause of which is Service Provider's negligence. Service Provider will pay all indemnities arising from such incidents and will not hold the Bank responsible or obligated.	Requested Changes : The Bidder is liable for any claim, demand, losses, liabilities or expenses of any nature and kind whatsoever which are directly attributable to it and not otherwise.	Terms & Conditions applicable as per RFP
65	34.6	SERVICE PROVIDER'S OBLIGATIONS:	If required by Bank, Vendor shall provide necessary training from the OEM to the designated SBI officials and / or its representative on the configuration, operation / functionalities, maintenance, support & administration for software / hardware and components, installation, troubleshooting	We request bank to consider mutual agreed cost for such training. As this is TOM model RFP and the selected bidder is responsible for the functionality.	Terms & Conditions applicable as per RFP

		processes of the proposed solution.		
--	--	-------------------------------------	--	--

66	36	INTELLECTUAL PROPERTY RIGHTS AND OWNERSHIP:	INTELLECTUAL PROPERTY RIGHTS AND OWNERSHIP:	<p>1. The Bidder indemnifies to the Bank against all costs, claims, damages, demands, expenses and liabilities whatsoever nature arising out of or in connection with all claims of infringement of Intellectual Property Right. Hence, the Bidder requests the Bank to delete the sub clause 36.4 to 36.8 except " Service Provider shall have no obligations with respect to any infringement claims to the extent that the infringement claim arises or results from: (i)Service Provider's compliance with the Bank's specific technical designs or instructions or (ii) any unauthorized modification or alteration of the deliverable (if any) by the Bank."</p> <p>2. Bidder would like to discuss with Bank to make the mutually agreeable clause.</p>	Terms & Conditions applicable as per RFP
----	----	---	---	--	--



66	36.6	INTELLECTUAL PROPERTY RIGHTS AND OWNERSHIP	<p>Service provider agrees that the Bank owns the entire right, title and interest to any inventions, designs, discoveries, writings and works of authorship, including all intellectual property rights, copyrights. Any work made under this RFP FOR TOM P-XVII 13,500 ATMs Page 67 of 421 RFP shall be deemed to be 'work made for hire' under any Indian/U.S. or any other applicable copyright laws.</p>	<p>For all changes that have been made for SBI under any Change Requests raised by SBI shall be considered as SBI's Intellectual Property</p>	<p>Terms &amp; Conditions applicable as per RFP</p>
----	------	--	---	---	---

66	36. INTELLECTUAL PROPERTY RIGHTS AND OWNERSHIP:	INTELLECTUAL PROPERTY RIGHTS AND OWNERSHIP:	36.3. Subject to clause 36.4 and 36.5 of this RFP, Service Provider shall, at its own expenses without any limitation, indemnify and keep fully and effectively indemnified the Bank against all costs, claims, damages, demands, expenses and liabilities whatsoever nature arising out of or in connection with all claims of infringement of Intellectual Property Right, including patent, trademark, copyright, trade secret or industrial design rights of any third party arising from the Services or use of the technology / software / products or any part thereof in India or abroad.	Requested Changes : The Bidder shall indemnify the Bank against the losses and damages which are directly attributable to the Bank and not otherwise.	Terms & Conditions applicable as per RFP
----	---	---	---	---	--

67	36.7	INTELLECTUAL PROPERTY RIGHTS AND OWNERSHIP	<p>The Intellectual Property Rights on the software code, copyright and source code for various applications/ interfaces developed under this RFP, and any other component/ framework/ middleware used/ developed as pre-built software assets to deliver the solution, shall belong to the Bank and the Bank shall have complete and unrestricted rights on such property. However, Service Provider shall hold All Intellectual Property rights in any pre-built software per se, except for those which have been assigned under this RFP.</p>	<p>For all changes that have been made for SBI under any Change Requests raised by SBI shall be considered as SBI's Intellectual Property</p>	<p>Terms &amp; Conditions applicable as per RFP</p>
----	------	--	---	---	---

67	37	<p><b>37. LIQUIDATED DAMAGES:</b></p>	<p>If Service Provider fails to deliver and perform any or all the Services within the stipulated time, schedule as specified in this RFP/Agreement, the Bank may, without prejudice to its other remedies under the RFP/Agreement, and unless otherwise extension of time is agreed upon without the application of liquidated damages, deduct from the Project Cost, as liquidated damages a sum equivalent to 0.5% of total Project Cost for delay of each week or part thereof maximum up to 5% of total Project Cost. Once the maximum deduction is reached, the Bank may consider termination of the Agreement</p>	<p>In bidder's assessment, liquidated damage shall only be applicable in the event of delay in delivering CD within the timelines stipulated under this RFP. For all other cases, like delay in delivering services specific penalties are already part of the RFP. Further, Bidder, requests to change the cap of liquidated damages from 5% of the project cost from 5% of the value of the undelivered CD as Bank should not penalized bidder for the machines ( CD ) already delivered within the time lines stipulated herein.</p>	<p>Terms &amp; Conditions applicable as per RFP</p>
----	----	---------------------------------------	--	---	---

67

37

If Service Provider fails to deliver and perform any or all the Services within the stipulated time, schedule as specified in this RFP/Agreement, the Bank may, without prejudice to its other remedies under the RFP/Agreement, and unless otherwise extension of time is agreed upon without the application of liquidated damages, deduct from the Project Cost, as liquidated damages a sum equivalent to 0.5% of total Project Cost for delay of each week or part thereof maximum up to 5% of total Project Cost. Once the maximum deduction is reached, the Bank may consider termination of the Agreement

If Service Provider fails to deliver and perform any or all the Services within the stipulated time, schedule as specified in this RFP/Agreement, the Bank may, without prejudice to its other remedies under the RFP/Agreement, and unless otherwise extension of time is agreed upon without the application of liquidated damages, deduct from the Project Cost, as liquidated damages a sum equivalent to 0.5% of total Project Cost for delay of each week or part thereof maximum up to 5% of total Project Cost. Once the maximum deduction is reached, the Bank may consider termination of the Agreement

In bidder's assessment, liquidated damage shall only be applicable in the event of delay in delivering CD within the timelines stipulated under this RFP. For all other cases, like delay in delivering services specific penalties are already part of the RFP. Further, Bidder, requests to change the cap of liquidated damages from 5% of the project cost from 5% of the value of the undelivered CD as Bank should not penalized bidder for the machines ( CD ) already delivered within the time lines stipulated herein.

Terms & Conditions applicable as per RFP

67	37	Liquidated Damages	<p>If Service Provider fails to deliver and perform any or all the Services within the stipulated time, schedule as specified in this RFP/Agreement, the Bank may, without prejudice to its other remedies under the RFP/Agreement, and unless otherwise extension of time is agreed upon without the application of liquidated damages, deduct from the Project Cost, as liquidated damages a sum equivalent to 0.5% of total Project Cost for delay of each week or part thereof maximum up to 5% of total Project Cost. Once the maximum deduction is reached, the Bank may consider termination of the Agreement.</p>	<p>We request the Bank to consider liquidated damages as per actual damages</p>	<p>Terms &amp; Conditions applicable as per RFP</p>
----	----	--------------------	---	---	---

67	37	LIQUIDATED DAMAGES	<p>If Service Provider fails to deliver and perform any or all the Services within the stipulated time, schedule as specified in this RFP/Agreement, the Bank may, without prejudice to its other remedies under the RFP/Agreement, and unless otherwise extension of time is agreed upon without the application of liquidated damages, deduct from the Project Cost, as liquidated damages a sum equivalent to 0.5% of total Project Cost for delay of each week or part thereof maximum up to 5% of total Project Cost. Once the maximum deduction is reached, the Bank may consider termination of the Agreement</p>	<p>All the performance related deficiencies are covered through defined penalties. Would request the Bank to re-evaluate this point.</p>	<p>Terms &amp; Conditions applicable as per RFP</p>
----	----	--------------------	--	--	---

67	37 and clause 10 of Appendix J (PAGE 67 AND 346)	Liquidated damages	<p>If Service Provider fails to deliver and perform any or all the Services within the stipulated time, schedule as specified in this RFP/Agreement, the Bank may, without prejudice to its other remedies under the RFP/Agreement, and unless otherwise extension of time is agreed upon without the application of liquidated damages, deduct from the Project Cost, as liquidated damages a sum equivalent to 0.5% of total Project Cost for delay of each week or part thereof maximum up to 5% of total Project Cost. Once the maximum deduction is reached, the Bank may consider termination of the Agreement.</p>	<p>Either the penalty or Liquidated damages should be levied, Bank should not levy both. Further, before levying Liquidated damages or invoking Bank guarantee, Bank should provide reasonable period to cure the defect / delay, if any. Further, the Bidder shall be accountable for damages only if the reason for the same is directly attributable to the Bidder and not otherwise.</p>	<p>Terms &amp; Conditions applicable as per RFP</p>
----	--	--------------------	---	--	---



67	37. LIQUIDATED DAMAGES:	-	<p>If Service Provider fails to deliver and perform any or all the Services within the stipulated time, schedule as specified in this RFP/Agreement, the Bank may, without prejudice to its other remedies under the RFP/Agreement, and unless otherwise extension of time is agreed upon without the application of liquidated damages, deduct from the Project Cost, as liquidated damages a sum equivalent to 0.5% of total Project Cost for delay of each week or part thereof maximum up to 5% of total Project Cost. Once the maximum deduction is reached, the Bank may consider termination of the Agreement.</p>	<p>Requested Changes : Bank to provide a cure period in the circumstances mentioned in the clause before levying liquidated damages on the Bidder. Further under no circumstance shall bank levy the liquidated damages without the consent of the Bidder.</p>	<p>Terms &amp; Conditions applicable as per RFP</p>
----	----------------------------	---	---	--	---

70	39.5.1	Holiday Listing (Temporary Debarment - suspension):	Whenever a Vendor is found lacking in performance, in case of less frequent and less serious misdemeanours, the vendors may be put on a holiday listing (temporary debarment) for a period upto 12 (twelve) months. When a Vendor is on the holiday listing, he is neither invited to bid nor are his bids considered for evaluation during the period of the holiday. The Vendor is, however, not removed from the list of empaneled vendors, if any. Performance issues which may justify holiday listing of the Vendor are	We suggest that Bank should provide a cure period to rectify such error/lack of performance prior to putting the bidder on a holiday listing.	Terms & Conditions applicable as per RFP
72	40	TERMINATION FOR DEFAULT	TERMINATION FOR DEFAULT	We request the bank to include Bidder's right to terminate in case there is unreasonable delay beyond 60 days of undisputed invoices of the Service Provider by the Bank.	Terms & Conditions applicable as per RFP

72	40. TERMINATIO N FOR DEFAULT:	TERMINATION FOR DEFAULT:	-	Requested Changes : Similarly Bidder shall also have the right to terminate the Agreement if Bank defaults in fulfilling its obligations under the scope of the Agreement by giving a written notice of 30 days	Terms & Conditions applicable as per RFP
73	40.2	TERMINATION FOR DEFAULT	In the event the Bank terminates the Contract in whole or in part for the breaches attributable to Service Provider, the Bank may procure, upon such terms and in such manner as it deems appropriate, Services similar to those undelivered, and subject to limitation of liability clause of this RFP Service Provider shall be liable to the Bank for any increase in cost for such similar Services. However, Service Provider shall continue performance of the Contract to the extent not terminated.	In case of a breach attributable to the Bidder, Bank's sole right shall be to terminate the agreement and any Services similar to the ones undelivered by the Bidder shall not be placed as Bidder's liability and not shall the Bidder be responsible to pay for the increase in the cost of such services	Terms & Conditions applicable as per RFP

73	40.5	TERMINATION FOR DEFAULT	The Bank's right to terminate the Contract will be in addition to the penalties / liquidated damages and other actions as specified in this RFP.	Bank's right to terminate the contract due to no fault of the Bidder shall be subject to Bank providing 30 days written notice to the Bidder	Terms & Conditions applicable as per RFP
73	40.5	Termination for default	The Bank's right to terminate the Contract will be in addition to the penalties / liquidated damages and other actions as specified in this RFP.	We suggest that this clause should be waived of.	Terms & Conditions applicable as per RFP

74	41	FORCE MAJEURE:	<p>For the purposes of this clause, 'Force Majeure' means and includes wars, insurrections, revolution, civil disturbance, riots, terrorist acts, public strikes, hartal, bundh, fires, floods, epidemic, quarantine restrictions, freight embargoes, declared general strikes in relevant industries, Vis Major, acts of Government in their sovereign capacity, Curfew or Lockdowns by notification of the State / District Govts impeding reasonable performance of Service Provider and / or Sub-Contractor but does not include any foreseeable events, commercial considerations or those involving fault or negligence on the part of the party claiming Force Majeure.</p>	<p>We request bank to include Satellite or transponder failure as a part of force majeure.</p>	<p>Terms &amp; Conditions applicable as per RFP</p>
----	----	----------------	--	--	---

74	41	FORCE MAJEURE	<p>For the purposes of this clause, 'Force Majeure' means and includes wars, insurrections, revolution, civil disturbance, riots, terrorist acts, public strikes, hartal, bundh, fires, floods, epidemic, quarantine restrictions, freight embargoes, declared general strikes in relevant industries, Vis Major, acts of Government in their sovereign capacity, Curfew or Lockdowns by notification of the State / District Govts impeding reasonable performance of Service Provider and / or Sub-Contractor but does not include any foreseeable events, commercial considerations or those involving fault or negligence on the part of the party claiming Force Majeure.</p>	<p>We request bank to include Satellite or transponder failure as a part of force majeure.</p>	<p>Terms &amp; Conditions applicable as per RFP</p>
----	----	---------------	--	--	---

74	41	FORCE MAJEURE	<p>For the purposes of this clause, 'Force Majeure' means and includes wars, insurrections, revolution, civil disturbance, riots, terrorist acts, public strikes, hartal, bundh, fires, floods, epidemic, quarantine restrictions, freight embargoes, declared general strikes in relevant industries, Vis Major, acts of Government in their sovereign capacity, Curfew or Lockdowns by notification of the State / District Govts impeding reasonable performance of Service Provider and / or Sub-Contractor but does not include any foreseeable events, commercial considerations or those involving fault or negligence on the part of the party claiming Force Majeure.</p>	<p>We request bank to include Satellite or transponder failure as a part of force majeure.</p>	<p>Terms &amp; Conditions applicable as per RFP</p>
----	----	---------------	--	--	---

74	41	FORCE MAJEURE:	<p>For the purposes of this clause, 'Force Majeure' means and includes wars, insurrections, revolution, civil disturbance, riots, terrorist acts, public strikes, hartal, bundh, fires, floods, epidemic, quarantine restrictions, freight embargoes, declared general strikes in relevant industries, Vis Major, acts of Government in their sovereign capacity, Curfew or Lockdowns by notification of the State / District Govts impeding reasonable performance of Service Provider and / or Sub-Contractor but does not include any foreseeable events, commercial considerations or those involving fault or negligence on the part of the party claiming Force Majeure.</p>	<p>We request bank to include Satellite or transponder failure as a part of force majeure.</p>	<p>Terms &amp; Conditions applicable as per RFP</p>
----	----	----------------	--	--	---



74	41.2	FORCE MAJEURE:	<p>For the purposes of this clause, 'Force Majeure' means and includes wars, insurrections, revolution, civil disturbance, riots, terrorist acts, public strikes, hartal, bundh, fires, floods, epidemic, quarantine restrictions, freight embargoes, declared general strikes in relevant industries, Vis Major, acts of Government in their sovereign capacity, Curfew or Lockdowns by notification of the State / District Govts impeding reasonable performance of Service Provider and / or Sub-Contractor but does not include any foreseeable events, commercial considerations or those involving fault or negligence on the part of the party claiming Force Majeure.</p>	<p>We request bank to include Satellite or transponder failure as a part of force majeure.</p>	<p>Terms &amp; Conditions applicable as per RFP</p>
----	------	----------------	--	--	---

74	41.3	FORCE MAJEURE	<p>If a Force Majeure situation arises, Service Provider shall promptly notify the Bank in writing of such condition and the cause thereof. Unless otherwise directed by the Bank in writing, Service Provider shall continue to perform its obligations under the Contract as far as is reasonably practical and shall seek all reasonable alternative means for performance not prevented by the Force Majeure event</p>	<p>In case of a Force Majeure scenario, both parties must evaluate the feasibility of providing services and availing services and the decision to perform the obligation under the Contract shall be mutually decided and agreed by the parties</p>	<p>Terms &amp; Conditions applicable as per RFP</p>
----	------	---------------	--	--	---

74	41. FORCE MAJEURE:	For the purposes of this clause, 'Force Majeure' means and includes wars, insurrections, revolution, civil disturbance, riots, terrorist acts, public strikes, hartal, bundh, fires, floods, epidemic, quarantine restrictions, freight embargoes, declared general strikes in relevant industries, Vis Major, acts of Government in their sovereign capacity, Curfew or Lockdowns by notification of the State / District Govts impeding reasonable performance of Service Provider and / or Sub-Contractor but does not include any foreseeable events, commercial considerations or those involving fault or negligence on the part of the party claiming Force Majeure.	For the purposes of this clause, 'Force Majeure' means and includes wars, insurrections, revolution, civil disturbance, riots, terrorist acts, public strikes, hartal, bundh, fires, floods, epidemic, quarantine restrictions, freight embargoes, declared general strikes in relevant industries, Vis Major, acts of Government in their sovereign capacity, Curfew or Lockdowns by notification of the State / District Govts impeding reasonable performance of Service Provider and / or Sub-Contractor but does not include any foreseeable events, commercial considerations or those involving fault or negligence on the part of the party claiming Force Majeure.	We request bank to include Satellite or transponder failure as a part of force majeure.	Terms & Conditions applicable as per RFP
----	--------------------	---	---	---	--

74

41. FORCE MAJEURE:

For the purposes of this clause, 'Force Majeure' means and includes wars, insurrections, revolution, civil disturbance, riots, terrorist acts, public strikes, hartal, bundh, fires, floods, epidemic, quarantine restrictions, freight embargoes, declared general strikes in relevant industries, Vis Major, acts of Government in their sovereign capacity, Curfew or Lockdowns by notification of the State / District Govts impeding reasonable performance of Service Provider and / or Sub-Contractor but does not include any foreseeable events, commercial considerations or those involving fault or negligence on the part of the party claiming Force Majeure.

We request bank to include Satellite or transponder failure as a part of force majeure.

Terms & Conditions applicable as per RFP

74	42. TERMINATIO N FOR INSOLVENCY:	TERMINATION FOR INSOLVENCY:	-	Requested Changes:- Similarly Bidder shall also have a right to terminate the Contract by giving written notice, if any insolvency or bankruptcy proceedings has been filed against the Bank	Terms & Conditions applicable as per RFP
75	43	TERMINATION FOR CONVENIENCE	43.1. The Bank, by written notice of not less than 90 (ninety) days, may terminate the Contract, in whole or in part, for its convenience, provided same shall not be invoked by the Bank before completion of half of the total Contract period (including the notice period).	This clause should be mutual in nature.	Terms & Conditions applicable as per RFP
75	43	TERMINATION FOR CONVENIENCE	TERMINATION FOR CONVENIENCE	We request Bank to consider payment of compensation for non cancellable services towards which service provider had incurred expenses based on Bank's commitment under RFP in case Bank is terminating the Agreement without any cause attributable to the Service Provider.	Terms & Conditions applicable as per RFP

75	43.1	43. TERMINATION FOR CONVENIENCE:	The Bank, by written notice of not less than 90 (ninety) days, may terminate the Contract, in whole or in part, for its convenience, provided same shall not be invoked by the Bank before completion of half of the total Contract period (including the notice period)	Should be on mutually agreed terms as Bidder is making significant investment and the entire proposal is based on the assumption that contract will live its full term.	Terms & Conditions applicable as per RFP
75	43.1	TERMINATION FOR CONVENIENCE	The Bank, by written notice of not less than 90 (ninety) days, may terminate the Contract, in whole or in part, for its convenience, provided same shall not be invoked by the Bank before completion of half of the total Contract period (including the notice period).	Termination for convenience is itself arbitrary and unjust and so should not form part of tender or RFP. Termination for convenience to be invoked only after execution of 50% of the work is also arbitrary and needs to be removed. We also request Bank to buyback the assets at WDV in case of termination.	Terms & Conditions applicable as per RFP

75	43.1	TERMINATION FOR CONVENIENCE	The Bank, by written notice of not less than 90 (ninety) days, may terminate the Contract, in whole or in part, for its convenience, provided same shall not be invoked by the Bank before completion of half of the total Contract period (including the notice period).	We request the Bank for considering this point, as - <i>"The Bank, by written notice of not less than 90 (ninety) days, may terminate the Contract, in whole or in part, for its convenience, provided same shall not be invoked by the Bank before completion of 5 years of Contract period (including the notice period)"</i> .	Terms & Conditions applicable as per RFP
----	------	-----------------------------	---	---	--

75	43.1	The Bank, by written notice of not less than 90 (ninety) days, may terminate the Contract, in whole or in part, for its convenience, provided same shall not be invoked by the Bank before completion of half of the total Contract period (including the notice period)	The Bank, by written notice of not less than 90 (ninety) days, may terminate the Contract, in whole or in part, for its convenience, provided same shall not be invoked by the Bank before completion of half of the total Contract period (including the notice period)	Should be on mutually agreed terms as Bidder is making significant investment and the entire proposal is based on the assumption that contract will live its full term.	Terms & Conditions applicable as per RFP
75	43.2	TERMINATION FOR CONVENIENCE	In the event of termination of the Agreement for the Bank's convenience, Service Provider shall be entitled to receive payment for the Services rendered (delivered) up to the	If Bank terminates the agreement for convenience, then the payment for the services shall be till the delivery of the services (if the same stretches beyond the date of termination)	Terms & Conditions applicable as per RFP



			effective date of termination		
75	43. TERMINATION FOR CONVENIENCE:	TERMINATION FOR CONVENIENCE:	-	Requested Changes : Similarly Bidder shall also have the right to terminate the Agreement by giving a written notice of 90 days without assigning any reason whatsoever.	Terms & Conditions applicable as per RFP

75	43.1  18.3	TERMINATION FOR CONVENIENCE:	<p>The Bank, by written notice of not less than 90 (ninety) days, may terminate the Contract, in whole or in part, for its convenience, provided same shall not be invoked by the Bank before completion of half of the total Contract period (including the notice period).</p> <p>The Bank, by written notice of not less than 60 (sixty) days may terminate the Contract, in whole or in part, for its convenience. In the event of termination of the Agreement for the Bank's convenience, Service Provider shall be entitled to receive payment for the Services rendered (delivered) up to the effective date of termination.</p>	<p>At the outset, we are unable to agree for termination for convenience keeping in view the upfront financial and operational commitments made for a Project of this tenor and scale.</p> <p>Hence, the Bidder requests the Bank to delete the termination rights for its convenience.</p>	Terms & Conditions applicable as per RFP
----	------------------	------------------------------	--	---	--

79	5.1.2.5	Selected Bidder's Obligations	The Bidder will abide by the job safety measures prevalent in India and will free the Bank from all demands or responsibilities arising from accidents or loss of life, the cause of which is the Bidder's negligence.	Furthermore, if the Bidder acts and abides by directives issued by the Bank, then it shall stand absolved of such liabilities including but not limited to accidents or loss of life when acting as per directives received from the Bank	Terms & Conditions applicable as per RFP
----	---------	-------------------------------	--	---	--

80	52	Assignment	<p>52.1. Service Provider shall not transfer or assign at any stage, during the currency of the contract and extension thereof, any of its duties, responsibilities, obligations and benefits of this agreement to any third party / financial institution / entity without the prior written consent of the Bank.,</p> <p>52.2. Bank can transfer or assign any service or all services under contract at any stage to an Affiliate / subsidiary /Joint Venture etc. during the currency of contract and inform to the vendors.</p>	<p>We suggest deletion of clause 52.2. The Bank has a right to terminate and in the event of any default, the Bank can terminate. But assigning the services to any third party would cause damage to the bidders' revenue.</p>	<p>Terms &amp; Conditions applicable as per RFP</p>
----	----	------------	--	---	---

80	53	INDEMNITY	INDEMNITY	<p>Scope of indemnity is very broad.</p> <p>Bidder would like to clarify that Bidder is willing to indemnify only for any breach of confidentiality, gross negligence and wilful misconduct (directly attributable) on the part of Bidder and its sub-contractor, breach of intellectual property rights and for violation of any relevant local laws that are applicable to the provision of services under the agreement. Bidder will be unable to indemnify the Bank for any other reasons which are not directly attributable to Bidder or its subcontractor.</p>	Terms & Conditions applicable as per RFP
----	----	-----------	-----------	---	--

80	53	Indemnity	<p>53.1 The Vendor hereby indemnifies the Bank, and shall always keep indemnified and hold the Bank, its employees, personnel, directors, (hereinafter collectively referred to as "Personnel") harmless from and against any and all losses, liabilities, claims, actions, costs and expenses (including attorneys' fees) awarded against the Bank relating to, resulting directly from or arising out of any claim, suit or proceeding brought against the Bank, as a result of:</p>	<p>We propose a change in red line below:53.1  <b>Subject to the reconciliation process</b> The Vendor hereby indemnifies the Bank, and shall always keep indemnified and hold the Bank, its employees, personnel, directors, (hereinafter collectively referred to as "Personnel") harmless from and against any and <b>all direct and proven losses</b>, liabilities, claims, actions, costs and expenses (including attorneys' fees) awarded against the Bank relating to, resulting directly from or arising out of any claim, suit or proceeding brought against the Bank, as a result of:</p> <p><b>SBI shall, while making any indemnity claim, provide a detailed notice of such claim together with relevant supporting documents Service Provider shall not be responsible under indemnity provisions in this Agreement to the extent that loss is attributable to the negligence and/or breach of this Agreement or breach of</b></p>	<p>Terms &amp; Conditions applicable as per RFP</p>
----	----	-----------	--	--	---

			<p>applicable Laws by SBI or its employees or for any services that is availed by PNBFHL outside the scope of this Agreement</p> <p>53.7 We are also suggesting to add amount for limitation of liability.</p>	
--	--	--	--	--

80	53. INDEMNITY	INDEMNITY	-	<p>Requested Changes : Similarly Bank shall indemnify, protect and save the Bidder and hold the Bidder harmless from and against all claims, losses, costs, damages, expenses, action suits and other proceedings, (including reasonable attorney fees), relating to or resulting directly or indirectly from</p> <ul style="list-style-type: none"> <li>i breach of any of the terms of this RFP,</li> <li>ii. Infringement of any patent, trademarks, copyrights etc. of the Bidder</li> <li>iii. Bank shall indemnify the Bidder against any loss or damage to the Bidder's premises or property, loss of life, etc., due to the acts of the Bank's employees or representatives.</li> <li>iv. breach of any representation and warranties and breach of its obligations.</li> </ul> <p>However, Bidder shall not be liable for any indirect, incidental, consequential or punitive damages or for any loss of data &amp; loss of life under any circumstances whatsoever to the Bank.</p>	Terms & Conditions applicable as per RFP
----	------------------	-----------	---	---	--



82	53.4	53. INDEMNITY	<p>During the contract period, Vendor and its outsourced agents shall comply with all statutory, regulatory provisions, relevant laws, guidelines, advisories etc, time to time framed by the Central Government / State Government / Local Bodies / RBI / MHA or any other statutory authority (s), including but not limited to Shops &amp; Establishment Act, Minimum Wages Act, Contract Labour, Tax laws, all laws pertaining to contract employees required for providing the Services including Caretaker Services etc. and undertakes to keep the Bank indemnified against any such default (s) of his obligations under the compliance of such laws during the full contract period.</p>	<p>For implementation of any future guidelines which are not mentioned in this RFP, Bank shall pay for the implementation of the same in the field at mutually agreed price, we request bank to consider this request &amp; modify accordingly.</p>	<p>Terms &amp; Conditions applicable as per RFP</p>
----	------	---------------	---	---	---

82	53.4	<p>During the contract period, Vendor and its outsourced agents shall comply with all statutory, regulatory provisions, relevant laws, guidelines, advisories etc, time to time framed by the Central Government / State Government / Local Bodies / RBI / MHA or any other statutory authority (s), including but not limited to Shops &amp; Establishment Act, Minimum Wages Act, Contract Labour, Tax laws, all laws pertaining to contract employees required for providing the Services including Caretaker Services etc. and undertakes to keep the Bank indemnified against any such default (s) of his obligations under the compliance of such laws during the full contract period.</p>	<p>During the contract period, Vendor and its outsourced agents shall comply with all statutory, regulatory provisions, relevant laws, guidelines, advisories etc, time to time framed by the Central Government / State Government / Local Bodies / RBI / MHA or any other statutory authority (s), including but not limited to Shops &amp; Establishment Act, Minimum Wages Act, Contract Labour, Tax laws, all laws pertaining to contract employees required for providing the Services including Caretaker Services etc. and undertakes to keep the Bank indemnified against any such default (s) of his obligations under the compliance of such laws during the full contract period.</p>	<p>For implementation of any future guidelines which are not mentioned in this RFP, Bank shall pay for the implementation of the same in the field at mutually agreed price, we request bank to consider this request &amp; modify accordingly.</p>	<p>Terms &amp; Conditions applicable as per RFP</p>
----	------	---	---	---	---

83	54.8	54.8	Data Encryption/Protection requirements of the Bank.	Bank is requested to clarify which data bank wants bidder to encrypt / protect and from endpoint to which path.	Terms & Conditions applicable as per RFP
83	54.8	54.8	Data Encryption/Protection requirements of the Bank.	Bank is requested to clarify which data bank wants bidder to encrypt / protect and from endpoint to which path.	Terms & Conditions applicable as per RFP
83	54.8	54.8	Data Encryption/Protection requirements of the Bank.	Bank is requested to clarify which data bank wants bidder to encrypt / protect and from endpoint to which path.	Terms & Conditions applicable as per RFP
83	54.8	COMPLIANCE WITH IS SECURITY POLICY	Data Encryption/Protection requirements of the Bank	As per ATM OEM 2 - Bank is requested to clarify which data bank required to be encrypt / protect and from endpoint to until which path.	Terms & Conditions applicable as per RFP
83	54.8	INDEMNITY	Data Encryption/Protection requirements of the Bank.	Bank is requested to clarify which data bank wants bidder to encrypt / protect and from endpoint to which path.	Terms & Conditions applicable as per RFP
86	Appendix C1	5.8	Card reader should be capable of disabling reading the magstrip as and when required by the Bank. If physical visit is required for disablement, vendor to arrange the same at no additional cost to the Bank	This functionality is not at the ATM end rather ATM switch can decide whether to use EMV or Magnetic strip any point of time with no dependency at the ATM end. Request Bank to look into this and remove this clause from RFP	Terms & Conditions applicable as per RFP

87	57	Change in orders	The Bank may, at any time, by a written order given to the Vendor, make changes within the scope of the work and any other part of Contract as per bank business requirement and it shall be binding to the bidder.	The Bank may change the scope of work but with prior communication to the Bidder. Additionally, the Bidder should have a right to be heard in the event of such scenario.	Terms & Conditions applicable as per RFP
----	----	------------------	---	---	--

90	Annexure A - BID FORM (TECHNICAL BID)	BID FORM (TECHNICAL BID)	xiii. We hereby certify that on the date of submission of Bid for this RFP, <<we do not have / we have >> any past / present litigation which adversely affect our participation in this RFP or we are not under any debarment / blacklist period for breach of contract / fraud / corrupt practices by any Scheduled Commercial Bank / Public Sector Undertaking / State or Central Government or their agencies / departments. In case of past litigations (Running or closed) between Jan 2017 to till date, - We submit full details of the past litigations / present litigations as per Appendix-R).	Requested Changes :- Cannot agree for the same	Terms & Conditions applicable as per RFP
----	--	-----------------------------	--	--	--

91	Appendix A	xviii.	<p>In case, we are the existing Vendor of the Bank under the Ministry of Finance (MOF) Agreement / Bank's TOM Agreement (prior to year 2013), we shall surrender the existing ATM site to the Bank, as per Bank requirement or allocation under present RFP. We shall support the Bank &amp; the new vendor in assignment of the site rental agreement and other transition formalities to new vendor, without any additional cost to the Bank, within 30 days from the PO / instruction from the Bank for that site.</p>	<p>The existing Site ownership is with the landlord with whom the existing bidder has agreement. There are multiple factors which will be involved Commercial/Legal Hence this can be done only on best effort basis with no guarantee to use the same site within 30 days</p>	<p>Terms &amp; Conditions applicable as per RFP</p>
91	Appendix-A	APPENDIX-A BID FORM (TECHNICAL BID)	APPENDIX-A BID FORM (TECHNICAL BID)	<p>We request the bank to cover past statutory compliances such as EPF/GST/ESIC etc. of the bidder under declaration and completed the past projects as per allocation from the bank</p>	<p>Terms &amp; Conditions applicable as per RFP</p>

91	XVIII(a)	APPENDIX-A	In case, we are the existing Vendor of the Bank under the Ministry of Finance (MOF) Agreement / Bank's TOM Agreement (prior to year 2013), we shall surrender the existing ATM site to the Bank, as per Bank requirement or allocation under present RFP. We shall support the Bank & the new vendor in assignment of the site rental agreement and other transition formalities to new vendor, without any additional cost to the Bank, within 30 days from the PO / instruction from the Bank for that site.	Minimum 60 days	Terms & Conditions applicable as per RFP
93	2	Appendix-B: BIDDER'S ELIGIBILITY CRITERIA	The bidder must have an average annual turnover of minimum Rs. 60 crores during last 03 Three financial year(s),	Huge capital investments are required initially for such projects, request Bank to keep minimum annual turnover as Rs.200 crores are above during last 3 years	Terms & Conditions applicable as per RFP

93	2	Eligibility Critirea:	<p>Documents to be submitted/Document s to be uploaded</p> <p>Option 2 - If audited balance sheet is not available for FY 2022-23 then, Option 2- FY 2019-20, 20-21 and 21-22. In addition, provisional financials for FY 2022-23 duly certified by statutory auditor of that firm / company to be submitted OR self-declaration by authorized signatory if provisional financials of FY 2022-23 is not available (FOR OPTION 2 ONLY).</p>	<p>The financial stability of the bidder is critical for successful implementation of the project. Since the submission will be made in month of September, it is evident that in case bidders are not ready with their audited financials for FY2022-23, the provisional financials must be available. The self-declaration cannot be relied upon and hence should not be considered.</p> <p>Hence we propose Bank to remove the option of self-declaration by authorized signatory if provisional financials of FY 2022-23 is not available.</p>	Terms & Conditions applicable as per RFP
93	Appendix B	2	<p>The bidder must have an average annual turnover of minimum Rs. 60 crores during last 03 Three financial year(s),</p>	<p>For a project estimated to be 8000 to 9000 Crore Bank should look for financially stable companies who have atleast a turn over of minimum INR 500 Cr. Request the Bank to consider the same</p>	Terms & Conditions applicable as per RFP



95	6	Appendix-B: BIDDER'S ELIGIBILITY CRITERIA	Satisfactory <del>Two</del> Client references which can be Public Sector Banks (PSUs) / Private Sector Banks in India, from whom Bidder / OEM has executed similar projects for at least 500 ATMs (which are currently in working conditions) and their maintenance services, as on 31.03.2023. (Applicable to bidder(s) which are not engaged with SBI under "Per Transaction Rate Model")	Please clarify "Satisfactory Two Client references which can be Public Sector Banks (PSUs) / Private Sector Banks in India, from whom Bidder / OEM has executed similar projects for at least 500 ATMs <b>Each i.e. per Bank 500 ATMs</b> (which are currently in working conditions) and their maintenance services, as on 31.03.2023.	<b>CORRIGENDUM:</b> <del>Satisfactory Two Client references which can be Public Sector Banks (PSUs) / Private Sector Banks in India, from whom Bidder / OEM has executed similar projects for at least 500 ATMs (which are currently in working conditions) and their maintenance services, as on 31.03.2023. (Applicable to bidder(s) which are not engaged with SBI under "Per Transaction Rate Model")</del> Bidder should specifically confirm on their letter head in this regard as per Appendix-M
----	---	---	--	---	--

95	Appendix B - 6	Eligibility Criteria	<p>Satisfactory Two Client references which can be Public Sector Banks (PSUs) / Private Sector Banks in India, from whom Bidder / OEM has executed similar projects for at least 500 ATMs (which are currently in working conditions) and their maintenance services, as on 31.03.2023. (Applicable to bidder(s) which are not engaged with SBI under "Per Transaction Rate Model")</p>	<p>Clarification : We read this criteria as Bank Engagement means dealing with bank directly or indirectly for services under per Transaction Rate Model.</p> <p>Alternatively, we request bank to amend the point as follows:</p> <p><i>"Satisfactory Two Client references which can be Public Sector Bank (PSUs)/Private Sector Banks/Publicly Listed Companies in India, from whom Bidder / OEM has executed similar project for at least 500 ATMs (which are currently in working conditions) and their maintenance services, as on 31.03.2023. (Applicable to bidder(s) which are not engaged directly or indirectly with SBI under "Per Transaction Rate Model")"</i></p> <p><u>Reasons for suggested amendment:</u></p> <p>1.TSI India Pvt Ltd is a subsidiary of Findi Ltd, an Australia based publicly listed Entity having network of more than 100 crores</p>	<p><b>CORRIGENDUM:</b></p> <p><del>Satisfactory Two Client references which can be Public Sector Banks (PSUs) / Private Sector Banks in India, from whom Bidder / OEM has executed similar projects for at least 500 ATMs (which are currently in working conditions) and their maintenance services, as on 31.03.2023. (Applicable to bidder(s) which are not engaged with SBI under "Per Transaction Rate Model")</del></p> <p><del>Bidder should specifically confirm on their letter head in this regard as per Appendix M</del></p>
----	----------------	----------------------	---	---	--

2. In April-2016, SBI has accepted the engagement of TSI as an Outsourcing Service Provider through Mphasis for the entire fleet of SBI Opex ATMs

3. All the Service Agreements are directly between TSI and the respective vendors for managing the Cash, Maintenance, Insurance, AMC, Housekeeping, E-surveillance, etc.,

4. Since the engagement of TSI (in the year 2016), SBI Auditors have been periodically visiting TSI Office in Pune. The audits include a wholistic review of the SLAs followed by a comprehensive audit report to SBI Management detailing the effectiveness of TSI's control measures and Business Continuity Plans

5. In Year 2019-20, TSI took a decision to replace the entire fleet of 3900+ SBI ATMs with brand new ATMs, make TSI a sole Service Provider to do so.

6. The newly deployed all the assets for SBI portfolio viz; ATMs, UPS, Batteries and E-Surveillance Module were all procured and deployed by TSI.

			<p>7. As a result, TSI has continued to deliver the best-in-class ATM uptimes for SBI, topping the charts for most months, during the engagement so far.</p> <p>8. TSI, with their PAN India ATM footprint and Nodal offices in all major Customer locations, has recently completed deployment of 2400+ ATMs for a Public Sector Bank in India, offering all Services that are a part of the ongoing SBI Opex RFP</p>	
--	--	--	--	--

95	Eligibility Criteria	Eligibility Criteria	Satisfactory Two Client references which can be Public Sector Banks (PSUs) / Private Sector Banks in India, from whom Bidder / OEM has executed similar projects for at least 500 ATMs (which are currently in working conditions) and their maintenance services, as on 31.03.2023. (Applicable to bidder(s) which are not engaged with SBI under "Per Transaction Rate Model")	Execution of similar projects can be TOM as well as Managed Services.	<b>CORRIGENDUM:</b> <del>Satisfactory Two Client references which can be Public Sector Banks (PSUs) / Private Sector Banks in India, from whom Bidder / OEM has executed similar projects for at least 500 ATMs (which are currently in working conditions) and their maintenance services, as on 31.03.2023. (Applicable to bidder(s) which are not engaged with SBI under "Per Transaction Rate Model")</del> Bidder should specifically confirm on their letter head in this regard as per Appendix-M
96	Appendix-B: BIDDER'S ELIGIBILITY CRITERIA			Certifications Not Specified LM 79 for Modules LM 80 Report for LED Chips BIS Certificates for LED Display Modules & Power Supplies	Terms & Conditions applicable as per RFP

97	Eligibility Criteria	Eligibility Criteria	Bidder / should have Online Helpdesk / Management Centre Support Set up – 24 x 7 in India and providing technical support services on phone at least 5,000 ATMs and Support Centres at various locations.	Bidder / should have Online Helpdesk / Management Centre Support Set up – 24 x 7 in India and providing technical support services on phone at least 4,000 ATMs and Support Centres at various locations. The Online Helpdesk / Management Centre should have capability to add upto another 5000 ATMs.	Terms & Conditions applicable as per RFP
105	1.3.0	Processor	500 GB SSD (primary) or higher and 1 TB SATA / e-SATA HDD (secondary). In case, Bank requires primary SSD of 1 TB, the same should be installed without any additional cost to the Bank.	Requesting bank to change 500 GB SSD to 1 TB SATA as it is sufficient for ATM operations.	Terms & Conditions applicable as per RFP.

105	1.5.0		<p>Microsoft Windows 11 Else Microsoft Windows 10 Enterprise IOT 2019 or higher with latest service packs. In case supplied OS is declared end of support by Microsoft, the bidder has to replace the same with a supported OS including the supported hardware changes or provide compensating controls without any cost to Bank.</p>	<p><u>In case Bank decides to go with Native application,</u> request Bank to allow Linux OS option Justification: If the Bank get out of MVS, then requirement for Windows is not mandatory as</p> <ul style="list-style-type: none"> <li>- Windows is mandatory only for MVS &amp; Bank's current EPS</li> <li>- Linux native applications can meet bank's functional and security requirements</li> <li>- The Linux native application is successfully running in many PSU banks complying with all functional and security requirements including from RBI</li> <li>- the Bank anyways has many other applications running on Linux</li> <li>- Only after successful completion of UAT, Bank is going to give P.O / D.O</li> <li>- If later Banks moves to MVS, OEM is obliged to support MVS without any cost to the bank.</li> </ul>	<p>Terms &amp; Conditions applicable as per RFP.</p>
-----	-------	--	--	--	--

105	1.5.0		<p>Microsoft Windows 11 Else Microsoft Windows 10 Enterprise IOT 2019 or higher with latest service packs. In case supplied OS is declared end of support by Microsoft, the bidder has to replace the same with a supported OS including the supported hardware changes or provide compensating controls without any cost to Bank.</p>	<p><u>In case Bank decides to go with Native application,</u> request Bank to allow Linux OS option Justification: If the Bank get out of MVS, then requirement for Windows is not mandatory as</p> <ul style="list-style-type: none"> <li>- Windows is mandatory only for MVS &amp; Bank's current EPS</li> <li>- Linux native applications can meet bank's functional and security requirements</li> <li>- The Linux native application is successfully running in many PSU banks complying with all functional and security requirements including from RBI</li> <li>- the Bank anyways has many other applications running on Linux</li> <li>- Only after successful completion of UAT, Bank is going to give P.O / D.O</li> <li>- If later Banks moves to MVS, OEM is obliged to support MVS without any cost to the bank.</li> </ul>	<p>Terms &amp; Conditions applicable as per RFP.</p>
-----	-------	--	--	--	--



108	4.9.0	Appendix C1	Capable of dispensing all denominations Rs.50, Rs.100, Rs. 200/-,Rs. 500/-, Rs.2000, as well as new denominations, if any, issued subsequently without any extra cost to the Bank. All cassettes should be adjustable to hold and dispense the currency notes if dimensions of currency notes are changed without any additional component requirement	The bidder cannot envisage the size of the futuristic note and change in dimensions of currency notes may need additional hardware. Hence we Request the Bank to agree to mutual price in case of any new size currency note.	Terms & Conditions applicable as per RFP.
108	4.9.0	Appendix C1	Capable of dispensing all denominations Rs.50, Rs.100, Rs. 200/-,Rs. 500/-, Rs.2000, as well as new denominations, if any, issued subsequently without any extra cost to the Bank. All cassettes should be adjustable to hold and dispense the currency notes if dimensions of currency notes are changed without any	The bidder cannot envisage the size of the futuristic note and change in dimensions of currency notes may need additional hardware. Hence we Request the Bank to agree to mutual price in case of any new size currency note.	Terms & Conditions applicable as per RFP.

			additional component requirement		
108	4.9.0	Appendix-C1 → ATM Hardware	Capable of dispensing all denominations Rs.50, Rs.100, Rs. 200/-, Rs. 500/- as well as any new denominations, if any, issued subsequently during full contract period, without any extra cost to the Bank. All cassettes should be adjustable to hold and dispense the currency notes if dimensions of currency notes are changed without any	> Request bank to mutually conclude along with commercials, change in dimensions of currency notes may need additional hardware.	Terms & Conditions applicable as per RFP.

			additional component requirement.		
108	4.9.0	Appendix-C1 → ATM Hardware Dispenser	Capable of dispensing all denominations Rs.50, Rs.100, Rs. 200/-, Rs. 500/- as well as any new denominations, if any, issued subsequently during full contract period, without any extra cost to the Bank. All cassettes should be adjustable to hold and dispense the currency notes if dimensions of currency notes are changed without any	As per OEM 2 - The size cannot be envisaged for the futuristic notes and change in dimensions of currency notes may need additional hardware. Hence we request the Bank for its mutual discussion for an agreed incremental price, in case of any new size currency note introduced.	Terms & Conditions applicable as per RFP.

			additional component requirement.		
108	Appendix C1	4.9.0	Capable of dispensing all denominations Rs.50, Rs.100, Rs. 200/-,Rs. 500/-, Rs.2000, as well as new denominations, if any, issued subsequently without any extra cost to the Bank. All cassettes should be adjustable to hold and dispense the currency notes if dimensions of currency notes are changed without any	The bidder cannot envisage the size of the futuristic note and change in dimensions of currency notes may need additional hardware. Hence we Request the Bank to agree to mutual price in case of any new size currency note.	Terms & Conditions applicable as per RFP.

			additional component requirement		
108	Appendix C1	4.9.0	Capable of dispensing all denominations Rs.50, Rs.100, Rs. 200/-,Rs. 500/-, Rs.2000, as well as new denominations, if any, issued subsequently without any extra cost to the Bank. All cassettes should be adjustable to hold and dispense the currency notes if dimensions of currency notes are changed without any additional component requirement	The bidder cannot envisage the size of the futuristic note and change in dimensions of currency notes may need additional hardware. Hence we Request the Bank to agree to mutual price in case of any new size currency note.	Terms & Conditions applicable as per RFP.

109	Appendix-C1 → ATM Hardware 4.19.0		Any new foreign material inside the dispenser or at the presenter area should be sensed. If found, machine should be put out of service till be error is cleared	As of now there is only one solution available in the market which is block shaft provided by OEM which can restrict the fraudster to insert object. Shutter and presenter are being damaged when fraudster insert the object forcefully despite of block shaft. Alert mechanism is not available currently.	Terms & Conditions applicable as per RFP.
109	4.18.0	Appendix C1	Dispensation status should be logged for every withdrawal transaction. There cannot be any withdrawal transaction with status as 'Dispensation status unknown'	The unknown dispense error condition is a part of the CEN XFS specification. The information which will be recorded when such an event occurs is controlled by the ATM application and may be modified as per the banks requirements. Request the bank to acknowledge the same.	Terms & Conditions applicable as per RFP.
109	4.18.0	Appendix C1	Dispensation status should be logged for every withdrawal transaction. There cannot be any withdrawal transaction with status as 'Dispensation status unknown'	The unknown dispense error condition is a part of the CEN XFS specification. The information which will be recorded when such an event occurs is controlled by the ATM application and may be modified as per the banks requirements. Request the bank to acknowledge the same.	Terms & Conditions applicable as per RFP.

109	4.18.0	Appendix-C1 → ATM Hardware Dispenser	Dispensation status should be logged for every withdrawal transaction. There cannot be any withdrawal transaction with status as 'Dispensation status unknown'	As per OEM 2 - The unknown dispense error condition is a part of the CEN XFS specification. The information which will be recorded when such an event occurs is controlled by the ATM application and may be modified as per the banks requirements. Request the bank to acknowledge the same.	Terms & Conditions applicable as per RFP.
109	4.19.0	Appendix C1	Any new foreign material inside the dispenser or at the presenter area should be sensed. If found, machine should be put out of service till be error is cleared	Any dispenser fault / module blocked are handled correctly. In case of any frauds which are not known as on date we cannot consider this into account. Request Bank to look into this and remove this clause	Terms & Conditions applicable as per RFP.
109	4.19.0	Appendix C1	Any new foreign material inside the dispenser or at the presenter area should be sensed. If found, machine should be put out of service till be error is cleared	Any dispenser fault / module blocked are handled correctly. In case of any frauds which are not known as on date we cannot consider this into account. Request Bank to look into this and remove this clause	Terms & Conditions applicable as per RFP.

109	4.19.0	Appendix-C1 → ATM Hardware Dispenser	Any new foreign material inside the dispenser or at the presenter area should be sensed. If found, machine should be put out of service till be error is cleared	As per OEM 2 - Any dispenser fault / module blocked are handled correctly. In case of any frauds with new modulus operandi, which are not known as on date, it is difficult to consider into account. Hence, we request Bank to look into this and amend this point suitably.	Terms & Conditions applicable as per RFP.
109	Appendix C1	4.18.0	Dispensation status should be logged for every withdrawal transaction. There cannot be any withdrawal transaction with status as 'Dispensation status unknown'	The unknown dispense error condition is a part of the CEN XFS specification. The information which will be recorded when such an event occurs is controlled by the ATM application and may be modified as per the banks requirements. Request the bank to acknowledge the same.	Terms & Conditions applicable as per RFP.
109	Appendix C1	4.18.0	Dispensation status should be logged for every withdrawal transaction. There cannot be any withdrawal transaction with status as 'Dispensation status unknown'	The unknown dispense error condition is a part of the CEN XFS specification. The information which will be recorded when such an event occurs is controlled by the ATM application and may be modified as per the banks requirements. Request the bank to acknowledge the same.	Terms & Conditions applicable as per RFP.



109	Appendix C1	4.19.0	Any new foreign material inside the dispenser or at the presenter area should be sensed. If found, machine should be put out of service till be error is cleared	Any dispenser fault / module blocked are handled correctly. In case of any frauds which are not known as on date we cannot consider this into account. Request Bank to look into this and remove this clause	Terms & Conditions applicable as per RFP.
109	Appendix C1	4.19.0	Any new foreign material inside the dispenser or at the presenter area should be sensed. If found, machine should be put out of service till be error is cleared	Any dispenser fault / module blocked are handled correctly. In case of any frauds which are not known as on date we cannot consider this into account. Request Bank to look into this and remove this clause	Terms & Conditions applicable as per RFP.

111	5.6	Appendix C1	<p>Dip Smart Card Reader with anti-skimming device and anti-shimming device installed and integrated with the card reader of the ATM. Details of the anti-skimming technology / device to be enclosed. The bank is looking for a comprehensive skimming protection solution which achieves the following:- i) Senses unauthorized attachment of any device on the card reader module, ii) Sends the signal to switch and further to the Remote ATM Management Centre of the vendor and Online Monitoring Solution of the Bank, iii) Capable of enabling the switch to put the machine Out-Of-Service as well as block the card reader from accepting any</p>	<p>All devices comply to CEN XFS 3.10 or above standards. There is no SNMP stack available in the ATM devices hence request Bank to remove this clause and use CEN XFS 3.10 or above standards for MVS</p>	<p>Terms &amp; Conditions applicable as per RFP.</p>
-----	-----	-------------	--	--	--

		<p>more card insertions. XFS needs to send out error status so that the SNMP/MVS can pick it up and notify the monitoring system. iv) should be equipped with solution/device for protecting from Deep insert skimming and shimming.</p>		
--	--	--	--	--

111	5.6	Appendix C1	<p>Dip Smart Card Reader with anti-skimming device and anti-shimming device installed and integrated with the card reader of the ATM. Details of the anti-skimming technology / device to be enclosed. The bank is looking for a comprehensive skimming protection solution which achieves the following:- i) Senses unauthorized attachment of any device on the card reader module, ii) Sends the signal to switch and further to the Remote ATM Management Centre of the vendor and Online Monitoring Solution of the Bank, iii) Capable of enabling the switch to put the machine Out-Of-Service as well as block the card reader from accepting any</p>	<p>All devices comply to CEN XFS 3.10 or above standards. There is no SNMP stack available in the ATM devices hence request Bank to remove this clause and use CEN XFS 3.10 or above standards for MVS</p>	<p>Terms &amp; Conditions applicable as per RFP.</p>
-----	-----	-------------	--	--	--

		<p>more card insertions. XFS needs to send out error status so that the SNMP/MVS can pick it up and notify the monitoring system. iv) should be equipped with solution/device for protecting from Deep insert skimming and shimming.</p>		
--	--	--	--	--

111	5.6	Appendix-C1 → ATM Hardware Dip Card Reader (Hybrid)	Dip Smart Card Reader with anti-skimming device and anti-shimming device installed and integrated with the card reader of the ATM. Details of the anti- skimming technology / device to be enclosed. The bank is looking for a comprehensive skimming protection solution which achieves the following: - i) Senses unauthorized attachment of any device on the card reader module, ii) Sends the signal to switch and further to the Remote ATM Management Centre of the vendor and Online Monitoring Solution of the Bank, iii) Capable of enabling the switch to put the machine Out-Of-Service as well as block the card reader	As per OEM 2 - All devices comply to CEN XFS 3.10 or above standards. There is no SNMP stack available in the ATM devices hence request Bank to amend this point suitably and use CEN XFS 3.10 or above standards for MVS	Terms & Conditions applicable as per RFP.
-----	-----	--	---	---	---

		<p>from accepting any more card insertions. XFS needs to send out error status so that the SNMP/MVS can pick it up and notify the monitoring system.</p> <p>iv) should be equipped with solution/device for protecting from Deep insert skimming and shimmming.</p>		
--	--	---	--	--

111	Appendix C1	5.6	<p>Dip Smart Card Reader with anti-skimming device and anti-shimming device installed and integrated with the card reader of the ATM. Details of the anti-skimming technology / device to be enclosed. The bank is looking for a comprehensive skimming protection solution which achieves the following:- i) Senses unauthorized attachment of any device on the card reader module, ii) Sends the signal to switch and further to the Remote ATM Management Centre of the vendor and Online Monitoring Solution of the Bank, iii) Capable of enabling the switch to put the machine Out-Of-Service as well as block the card reader from accepting any</p>	<p>All devices comply to CEN XFS 3.10 or above standards. There is no SNMP stack available in the ATM devices hence request Bank to remove this clause and use CEN XFS 3.10 or above standards for MVS</p>	<p>Terms &amp; Conditions applicable as per RFP.</p>
-----	-------------	-----	--	--	--



		<p>more card insertions. XFS needs to send out error status so that the SNMP/MVS can pick it up and notify the monitoring system. iv) should be equipped with solution/device for protecting from Deep insert skimming and shimming.</p>		
--	--	--	--	--

111	Appendix C1	5.6	<p>Dip Smart Card Reader with anti-skimming device and anti-shimming device installed and integrated with the card reader of the ATM. Details of the anti-skimming technology / device to be enclosed. The bank is looking for a comprehensive skimming protection solution which achieves the following:- i) Senses unauthorized attachment of any device on the card reader module, ii) Sends the signal to switch and further to the Remote ATM Management Centre of the vendor and Online Monitoring Solution of the Bank, iii) Capable of enabling the switch to put the machine Out-Of-Service as well as block the card reader from accepting any</p>	<p>All devices comply to CEN XFS 3.10 or above standards. There is no SNMP stack available in the ATM devices hence request Bank to remove this clause and use CEN XFS 3.10 or above standards for MVS</p>	<p>Terms &amp; Conditions applicable as per RFP.</p>
-----	-------------	-----	--	--	--

		<p>more card insertions. XFS needs to send out error status so that the SNMP/MVS can pick it up and notify the monitoring system. iv) should be equipped with solution/device for protecting from Deep insert skimming and shimming.</p>		
--	--	--	--	--

112	5.8	Appendix C1	Card reader should be capable of disabling reading the magstripe as and when required by the Bank. If physical visit is required for disablement, vendor to arrange the same at no additional cost to the Bank	This functionality is not at the ATM end rather ATM switch can decide whether to use EMV or Magnetic strip any point of time with no dependency at the ATM end. Request Bank to look into this and remove this clause from RFP	Terms & Conditions applicable as per RFP.
112	5.8	Appendix C1	Card reader should be capable of disabling reading the magstrip as and when required by the Bank. If physical visit is required for disablement, vendor to arrange the same at no additional cost to the Bank	This functionality is not at the ATM end rather ATM switch can decide whether to use EMV or Magnetic strip any point of time with no dependency at the ATM end. Request Bank to look into this and remove this clause from RFP	Terms & Conditions applicable as per RFP.
112	5.8.0	Appendix-C1 → ATM Hardware Dip Card Reader (Hybrid)	Card reader should be capable of disabling reading the magstrip as and when required by the Bank. If physical visit is required for disablement, vendor to arrange the same at no additional cost to the Bank	As per OEM 2 - This functionality is not at the ATM end, rather switch can decide whether to use EMV or Magnetic strip any point of time with no dependency at the ATM end. Request Bank to look into this and amend this point suitably.	Terms & Conditions applicable as per RFP.

112	Appendix C1	5.8	Card reader should be capable of disabling reading the magstrip as and when required by the Bank. If physical visit is required for disablement, vendor to arrange the same at no additional cost to the Bank	This functionality is not at the ATM end rather ATM switch can decide whether to use EMV or Magnetic strip any point of time with no dependency at the ATM end. Request Bank to look into this and remove this clause from RFP	Terms & Conditions applicable as per RFP.
-----	-------------	-----	---	--	---

113	6.4.0	Appendix C1	<p>Rugged spill proof Triple DES enabled keyboard with polycarbonate tactile/stainless Steel EPP pin pad. EPP Keypads to be PCI-PTS compliant with sealed metal keypad. PIN Pads shall be covered to prevent PIN disclosure via shoulder surfing. EPP should be designed so as to prevent overlaying of fake pin pad. Forcible removal of EPP should bring the machine down resulting in loss of data stored in the EPP, so as to prevent compromise even with high end decryption. Please provide details of the technology / solution. Should accompany with PCI certificate. On expiry of certificate, it should be replaced with valid certificate at no additional cost to the</p>	<p>As per international standard on EPP key no 5 is having dot on the key pad &amp; today blind person do the transaction using TTS (Hindi &amp; English) using ear phone. So please consider EPP with current international standards.</p>	<p>Terms &amp; Conditions applicable as per RFP.</p>
-----	-------	-------------	---	---	--

		<p>Bank. EPP Pin Pad Should be with Braille Embossing's. In case, Braille Keypad (as shown pictures in this RFP) is not readily available, bidders can supply machine without Braille embossing's in each key. However, in case any guideline is issued by any entity (RBI/IBA/NPCI/ GoI etc.) to ensure each key with Braille Embossing, then the same should be provided by the bidder at no extra cost to the Bank. In case, any penalty is imposed on the Bank for not having the braille embossing in each key, the same should be made good by the bidder.</p>		
--	--	--	--	--

113	6.4.0	Appendix C1	<p>Rugged spill proof Triple DES enabled keyboard with polycarbonate tactile/stainless Steel EPP pin pad. EPP Keypads to be PCI-PTS compliant with sealed metal keypad. PIN Pads shall be covered to prevent PIN disclosure via shoulder surfing. EPP should be designed so as to prevent overlaying of fake pin pad. Forcible removal of EPP should bring the machine down resulting in loss of data stored in the EPP, so as to prevent compromise even with high end decryption. Please provide details of the technology / solution. Should accompany with PCI certificate. On expiry of certificate, it should be replaced with valid certificate at no additional cost to the</p>	<p><b>Request information:</b></p> <p>As mentioned in this RFP,</p> <p>.....if any directive is issued by any entity (RBI/IBA/NPCI/Gol etc.) to ensure each key is Braille-engraved....</p> <p>Please share these entities' guidelines or confirm that there are no guidelines for putting braille on every EPP keyboard.</p> <p>According to international regulations, there must be a dot on Key number 5 and not on each Key.</p> <p>Please share the guidelines to avoid misinterpretation.</p>	<p>Terms &amp; Conditions applicable as per RFP.</p>
-----	-------	-------------	---	--	--



		<p>Bank. EPP Pin Pad Should be with Braille Embossing's. In case, Braille Keypad (as shown pictures in this RFP) is not readily available, bidders can supply machine without Braille embossing's in each key. However, in case any guideline is issued by any entity (RBI/IBA/NPCI/ GoI etc.) to ensure each key with Braille Embossing, then the same should be provided by the bidder at no extra cost to the Bank. In case, any penalty is imposed on the Bank for not having the braille embossing in each key, the same should be made good by the bidder.</p> <p>Y F/N/C</p>		
--	--	---	--	--

113	6.4.0	Appendix C1	<p>Rugged spill proof Triple DES enabled keyboard with polycarbonate tactile/stainless Steel EPP pin pad. EPP Keypads to be PCI-PTS compliant with sealed metal keypad. PIN Pads shall be covered to prevent PIN disclosure via shoulder surfing. EPP should be designed so as to prevent overlaying of fake pin pad. Forcible removal of EPP should bring the machine down resulting in loss of data stored in the EPP, so as to prevent compromise even with high end decryption. Please provide details of the technology / solution. Should accompany with PCI certificate. On expiry of certificate, it should be replaced with valid certificate at no additional cost to the</p>	<p>As per international standard on EPP key no 5 is having dot on the key pad &amp; today blind person do the transaction using TTS (Hindi &amp; English) using ear phone. So please consider EPP with current international standards.</p>	<p>Terms &amp; Conditions applicable as per RFP.</p>
-----	-------	-------------	---	---	--

		<p>Bank. EPP Pin Pad Should be with Braille Embossing's. In case, Braille Keypad (as shown pictures in this RFP) is not readily available, bidders can supply machine without Braille embossing's in each key. However, in case any guideline is issued by any entity (RBI/IBA/NPCI/ GoI etc.) to ensure each key with Braille Embossing, then the same should be provided by the bidder at no extra cost to the Bank. In case, any penalty is imposed on the Bank for not having the braille embossing in each key, the same should be made good by the bidder.</p>		
--	--	--	--	--

113	6.4.0	Appendix C1	<p>Rugged spill proof Triple DES enabled keyboard with polycarbonate tactile/stainless Steel EPP pin pad. EPP Keypads to be PCI-PTS compliant with sealed metal keypad. PIN Pads shall be covered to prevent PIN disclosure via shoulder surfing. EPP should be designed so as to prevent overlaying of fake pin pad. Forcible removal of EPP should bring the machine down resulting in loss of data stored in the EPP, so as to prevent compromise even with high end decryption. Please provide details of the technology / solution. Should accompany with PCI certificate. On expiry of certificate, it should be replaced with valid certificate at no additional cost to the</p>	<p><b>Request information:</b></p> <p>As mentioned in this RFP,</p> <p>.....if any directive is issued by any entity (RBI/IBA/NPCI/Gol etc.) to ensure each key is Braille-engraved....</p> <p>Please share these entities' guidelines or confirm that there are no guidelines for putting braille on every EPP keyboard.</p> <p>According to international regulations, there must be a dot on Key number 5 and not on each Key.</p> <p>Please share the guidelines to avoid misinterpretation.</p>	<p>Terms &amp; Conditions applicable as per RFP.</p>
-----	-------	-------------	---	--	--

		<p>Bank. EPP Pin Pad Should be with Braille Embossing's. In case, Braille Keypad (as shown pictures in this RFP) is not readily available, bidders can supply machine without Braille embossing's in each key. However, in case any guideline is issued by any entity (RBI/IBA/NPCI/ GoI etc.) to ensure each key with Braille Embossing, then the same should be provided by the bidder at no extra cost to the Bank. In case, any penalty is imposed on the Bank for not having the braille embossing in each key, the same should be made good by the bidder.</p> <p>Y F/N/C</p>		
--	--	---	--	--

113	6.4.0	Appendix C1	<p>Rugged spill proof Triple DES enabled keyboard with polycarbonate tactile/stainless Steel EPP pin pad. EPP Keypads to be PCI-PTS compliant with sealed metal keypad. PIN Pads shall be covered to prevent PIN disclosure via shoulder surfing. EPP should be designed so as to prevent overlaying of fake pin pad. Forcible removal of EPP should bring the machine down resulting in loss of data stored in the EPP, so as to prevent compromise even with high end decryption. Please provide details of the technology / solution. Should accompany with PCI certificate. On expiry of certificate, it should be replaced with valid certificate at no additional cost to the</p>	<p>As per international standard on EPP key no 5 is having dot on the key pad &amp; today blind person do the transaction using TTS (Hindi &amp; English) using ear phone. So please consider EPP with current international standards.</p>	<p>Terms &amp; Conditions applicable as per RFP.</p>
-----	-------	-------------	---	---	--

		<p>Bank. EPP Pin Pad Should be with Braille Embossing's. In case, Braille Keypad (as shown pictures in this RFP) is not readily available, bidders can supply machine without Braille embossing's in each key. However, in case any guideline is issued by any entity (RBI/IBA/NPCI/ GoI etc.) to ensure each key with Braille Embossing, then the same should be provided by the bidder at no extra cost to the Bank. In case, any penalty is imposed on the Bank for not having the braille embossing in each key, the same should be made good by the bidder.</p>		
--	--	--	--	--

113	6.4.0	Appendix C1	<p>Rugged spill proof Triple DES enabled keyboard with polycarbonate tactile/stainless Steel EPP pin pad. EPP Keypads to be PCI-PTS compliant with sealed metal keypad. PIN Pads shall be covered to prevent PIN disclosure via shoulder surfing. EPP should be designed so as to prevent overlaying of fake pin pad. Forcible removal of EPP should bring the machine down resulting in loss of data stored in the EPP, so as to prevent compromise even with high end decryption. Please provide details of the technology / solution. Should accompany with PCI certificate. On expiry of certificate, it should be replaced with valid certificate at no additional cost to the</p>	<p>Request information:</p> <p>As mentioned in this RFP,</p> <p>.....if any directive is issued by any entity (RBI/IBA/NPCI/Gol etc.) to ensure each key is Braille-engraved....</p> <p>Please share these entities' guidelines or confirm that there are no guidelines for putting braille on every EPP keyboard.</p> <p>According to international regulations, there must be a dot on Key number 5 and not on each Key.</p> <p>Please share the guidelines to avoid misinterpretation.</p>	<p>Terms &amp; Conditions applicable as per RFP.</p>
-----	-------	-------------	---	---	--



		<p>Bank. EPP Pin Pad Should be with Braille Embossing's. In case, Braille Keypad (as shown pictures in this RFP) is not readily available, bidders can supply machine without Braille embossing's in each key. However, in case any guideline is issued by any entity (RBI/IBA/NPCI/ GoI etc.) to ensure each key with Braille Embossing, then the same should be provided by the bidder at no extra cost to the Bank. In case, any penalty is imposed on the Bank for not having the braille embossing in each key, the same should be made good by the bidder.</p> <p>Y F/N/C</p>		
--	--	---	--	--

113	6.4.0	Appendix C1	<p>Rugged spill proof Triple DES enabled keyboard with polycarbonate tactile/stainless Steel EPP pin pad. EPP Keypads to be PCI-PTS compliant with sealed metal keypad. PIN Pads shall be covered to prevent PIN disclosure via shoulder surfing. EPP should be designed so as to prevent overlaying of fake pin pad. Forcible removal of EPP should bring the machine down resulting in loss of data stored in the EPP, so as to prevent compromise even with high end decryption. Please provide details of the technology / solution. Should accompany with PCI certificate. On expiry of certificate, it should be replaced with valid certificate at no additional cost to the</p>	<p>As per international standard on EPP key no 5 is having dot on the key pad &amp; today blind person do the transaction using TTS (Hindi &amp; English) using ear phone. So please consider EPP with current international standards.</p>	<p>Terms &amp; Conditions applicable as per RFP.</p>
-----	-------	-------------	---	---	--

		<p>Bank. EPP Pin Pad Should be with Braille Embossing's. In case, Braille Keypad (as shown pictures in this RFP) is not readily available, bidders can supply machine without Braille embossing's in each key. However, in case any guideline is issued by any entity (RBI/IBA/NPCI/ GoI etc.) to ensure each key with Braille Embossing, then the same should be provided by the bidder at no extra cost to the Bank. In case, any penalty is imposed on the Bank for not having the braille embossing in each key, the same should be made good by the bidder.</p>		
--	--	--	--	--

113	6.4.0	Appendix C1	<p>Rugged spill proof Triple DES enabled keyboard with polycarbonate tactile/stainless Steel EPP pin pad. EPP Keypads to be PCI-PTS compliant with sealed metal keypad. PIN Pads shall be covered to prevent PIN disclosure via shoulder surfing. EPP should be designed so as to prevent overlaying of fake pin pad. Forcible removal of EPP should bring the machine down resulting in loss of data stored in the EPP, so as to prevent compromise even with high end decryption. Please provide details of the technology / solution. Should accompany with PCI certificate. On expiry of certificate, it should be replaced with valid certificate at no additional cost to the</p>	<p><b>Request information:</b></p> <p>As mentioned in this RFP,</p> <p>.....if any directive is issued by any entity (RBI/IBA/NPCI/Gol etc.) to ensure each key is Braille-engraved....</p> <p>Please share these entities' guidelines or confirm that there are no guidelines for putting braille on every EPP keyboard.</p> <p>According to international regulations, there must be a dot on Key number 5 and not on each Key.</p> <p>Please share the guidelines to avoid misinterpretation.</p>	<p>Terms &amp; Conditions applicable as per RFP.</p>
-----	-------	-------------	---	--	--

		<p>Bank. EPP Pin Pad Should be with Braille Embossing's. In case, Braille Keypad (as shown pictures in this RFP) is not readily available, bidders can supply machine without Braille embossing's in each key. However, in case any guideline is issued by any entity (RBI/IBA/NPCI/ GoI etc.) to ensure each key with Braille Embossing, then the same should be provided by the bidder at no extra cost to the Bank. In case, any penalty is imposed on the Bank for not having the braille embossing in each key, the same should be made good by the bidder.</p> <p>Y F/N/C</p>		
--	--	---	--	--

113	6.4.0	Appendix-C1 → ATM Hardware Customer Interface/EPP	<p>In case, Braille Keypad (as shown pictures in this RFP) is not readily available, bidders can supply machine without Braille embossings in each key. However, in case any guideline is issued by any entity (RBI/IBA/NPCI/ GoI etc.) to ensure each key with Braille Embossing, then the same should be provided by the bidder at no extra cost to the Bank. In case, any penalty is imposed on the Bank for not having the braille embossing in each key, the same should be made good by the bidder.</p>	<p>We request Bank to check with the OEM on the possibility/availability of EPP with Braille embossing in each key.</p> <p>As per ATM OEM 1 - Since, as per international standard in EPP, key no 5 must have dot on the pin pad. Moreover, blind person do the transaction using TTS (Hindi &amp; English) using ear phone. So please consider EPP with current international standards only.</p>	<p>Terms &amp; Conditions applicable as per RFP.</p>
-----	-------	---	---	--	--

113	6.4.0	<p>Rugged spill proof Triple DES enabled keyboard with polycarbonate tactile/stainless Steel EPP pin pad. EPP Keypads to be PCI-PTS compliant with sealed metal keypad. PIN Pads shall be covered to prevent PIN disclosure via shoulder surfing. EPP should be designed so as to prevent overlaying of fake pin pad. Forcible removal of EPP should bring the machine down resulting in loss of data stored in the EPP, so as to prevent compromise even with high end decryption. Please provide details of the technology / solution. Should accompany with PCI certificate. On expiry of certificate, it should be replaced with valid certificate at no additional cost to the</p>	<p>As per international standard on EPP key no 5 is having dot on the key pad &amp; today blind person do the transaction using TTS (Hindi &amp; English) using ear phone. So please consider EPP with current international standards.</p>	<p>Terms &amp; Conditions applicable as per RFP.</p>
-----	-------	---	---	--

		<p>Bank. EPP Pin Pad Should be with Braille Embossing's. In case, Braille Keypad (as shown pictures in this RFP) is not readily available, bidders can supply machine without Braille embossing's in each key. However, in case any guideline is issued by any entity (RBI/IBA/NPCI/ GoI etc.) to ensure each key with Braille Embossing, then the same should be provided by the bidder at no extra cost to the Bank. In case, any penalty is imposed on the Bank for not having the braille embossing in each key, the same should be made good by the bidder.</p>		
--	--	--	--	--



113	6.4.0	<p>Rugged spill proof Triple DES enabled keyboard with polycarbonate tactile/stainless Steel EPP pin pad. EPP Keypads to be PCI-PTS compliant with sealed metal keypad. PIN Pads shall be covered to prevent PIN disclosure via shoulder surfing. EPP should be designed so as to prevent overlaying of fake pin pad. Forcible removal of EPP should bring the machine down resulting in loss of data stored in the EPP, so as to prevent compromise even with high end decryption. Please provide details of the technology / solution. Should accompany with PCI certificate. On expiry of certificate, it should be replaced with valid certificate at no additional cost to the</p>	<p><b>Request information:</b></p> <p>As mentioned in this RFP,</p> <p>.....if any directive is issued by any entity (RBI/IBA/NPCI/Gol etc.) to ensure each key is Braille-engraved....</p> <p>Please share these entities' guidelines or confirm that there are no guidelines for putting braille on every EPP keyboard.</p> <p>According to international regulations, there must be a dot on Key number 5 and not on each Key.</p> <p>Please share the guidelines to avoid misinterpretation.</p>	<p>Terms &amp; Conditions applicable as per RFP.</p>
-----	-------	---	--	--

		<p>Bank. EPP Pin Pad Should be with Braille Embossing's. In case, Braille Keypad (as shown pictures in this RFP) is not readily available, bidders can supply machine without Braille embossing's in each key. However, in case any guideline is issued by any entity (RBI/IBA/NPCI/ GoI etc.) to ensure each key with Braille Embossing, then the same should be provided by the bidder at no extra cost to the Bank. In case, any penalty is imposed on the Bank for not having the braille embossing in each key, the same should be made good by the bidder.</p> <p>Y F/N/C</p>		
--	--	---	--	--

114	6.4.1	Appendix C1	<p>There shall be SBI's YONO branding colour scheme on the facia of the machine. The facia should be factory painted in the SBI INK BLUE COLOUR ( L481-105899 RGB 40-0-113 Hex #280071 ) scheme and YONO PRINTED vinyl wraps SHOULD BE STUCK ONTO THE MACHINES. During the life of the machine, any repair/replacement of facia should have the same original branding. The acrylic parts should be of the single SBI Blue colour specified in the RFP. The visible screen, keypad, front console can be as per OEM's default colour. The final colour appearance will be discussed with the successful bidders before implementation &amp;</p>	<p>We request Bank either go with standard colour scheme what ATM OEM offer and Yono colour brand can be done only using Vinyl wraps. Please look into the matter. This will also help in faster turn around time for deliveries.</p> <p>This will also help in future during the contract period if there is sudden requirement for additional machines then deliveries can be expedited if the machines are with standard colour scheme</p>	<p>Terms &amp; Conditions applicable as per RFP.</p>
-----	-------	-------------	---	---	--

		<p>rollout. The successful bidders should provide a 3D model representation for visualization and clarity. The Bank's decision will be binding on the successful bidder. The final appearance will be decided by the Bank after taking into consideration the 3D model.</p>		
--	--	---	--	--

114	6.4.1	Appendix C1	<p>There shall be SBI's YONO branding colour scheme on the facia of the machine. The facia should be factory painted in the SBI INK BLUE COLOUR ( L481-105899 RGB 40-0-113 Hex #280071 ) scheme and YONO PRINTED vinyl wraps SHOULD BE STUCK ONTO THE MACHINES. During the life of the machine, any repair/replacement of facia should have the same original branding. The acrylic parts should be of the single SBI Blue colour specified in the RFP. The visible screen, keypad, front console can be as per OEM's default colour. The final colour appearance will be discussed with the successful bidders before implementation &amp;</p>	<p>We request Bank either go with standard colour scheme what ATM OEM offer and Yono colour brand can be done only using Vinyl wraps. Please look into the matter. This will also help in faster turn around time for deliveries.</p> <p>This will also help in future during the contract period if there is sudden requirement for additional machines then deliveries can be expedited if the machines are with standard colour scheme</p>	<p>Terms &amp; Conditions applicable as per RFP.</p>
-----	-------	-------------	---	---	--

rollout. The successful bidders should provide a 3D model representation for visualization and clarity. The Bank's decision will be binding on the successful bidder. The final appearance will be decided by the Bank after taking into consideration the 3D model.

114	6.4.1	Appendix-C1 → ATM Hardware Customer Interface/Fascia	<p>There shall be SBI's YONO branding colour scheme on the facia of the machine. The facia should be factory painted in the SBI INK BLUE COLOUR (L481-105899 RGB 40-0-113 Hex #280071) scheme and YONO PRINTED vinyl wraps SHOULD BE STUCK ONTO THE MACHINES. During the life of the machine, any repair/replacement of facia should have the same original branding.</p> <p>The acrylic parts should be of the single SBI Blue colour specified in the RFP. The visible screen, keypad, front console can be as per OEM's default colour. The final colour appearance will be discussed with the successful bidders before implementation &amp;</p>	<p>As per ATM OEM 2 - We request Bank either to go with standard colour scheme as ATM OEM offers and Yono colour brand can be done only using Vinyl wraps. Please look into the matter. This will also help in faster turn around time for deliveries.</p> <p>This will also help in future during the contract period if there is sudden requirement for additional machines then deliveries can be expedited if the machines are with standard colour scheme.</p>	Terms & Conditions applicable as per RFP.
-----	-------	--	--	---	---

		<p>rollout. The successful bidders should provide a 3D model representation for visualization and clarity. The Bank's decision will be binding on the successful bidder. The final appearance will be decided by the Bank after taking into consideration the 3D model. There should not be fading or torn off vinyl wraps and their replacements to be done by the bidder on their own without waiting for Bank's intimation. If such replacement is advised by the Bank, it should be completed by the bidder within 5 days of intimation. Penalty @ ₹ 100 per day from the 6th Day onwards per non-complied ATM will be levied.</p>		
--	--	--	--	--



114	Appendix C1	6.4.1	<p>There shall be SBI's YONO branding colour scheme on the facia of the machine. The facia should be factory painted in the SBI INK BLUE COLOUR ( L481-105899 RGB 40-0-113 Hex #280071 ) scheme and YONO PRINTED vinyl wraps SHOULD BE STUCK ONTO THE MACHINES. During the life of the machine, any repair/replacement of facia should have the same original branding. The acrylic parts should be of the single SBI Blue colour specified in the RFP. The visible screen, keypad, front console can be as per OEM's default colour. The final colour appearance will be discussed with the successful bidders before implementation &amp;</p>	<p>We request Bank either go with standard colour scheme what ATM OEM offer and Yono colour brand can be done only using Vinyl wraps. Please look into the matter. This will also help in faster turn around time for deliveries.</p> <p>This will also help in future during the contract period if there is sudden requirement for additional machines then deliveries can be expedited if the machines are with standard colour scheme</p>	<p>Terms &amp; Conditions applicable as per RFP.</p>
-----	-------------	-------	---	---	--

rollout. The successful bidders should provide a 3D model representation for visualization and clarity. The Bank's decision will be binding on the successful bidder. The final appearance will be decided by the Bank after taking into consideration the 3D model.

114	Appendix C1	6.4.1	<p>There shall be SBI's YONO branding colour scheme on the facia of the machine. The facia should be factory painted in the SBI INK BLUE COLOUR ( L481-105899 RGB 40-0-113 Hex #280071 ) scheme and YONO PRINTED vinyl wraps SHOULD BE STUCK ONTO THE MACHINES. During the life of the machine, any repair/replacement of facia should have the same original branding. The acrylic parts should be of the single SBI Blue colour specified in the RFP. The visible screen, keypad, front console can be as per OEM's default colour. The final colour appearance will be discussed with the successful bidders before implementation &amp;</p>	<p>We request Bank either go with standard colour scheme what ATM OEM offer and Yono colour brand can be done only using Vinyl wraps. Please look into the matter. This will also help in faster turn around time for deliveries.</p> <p>This will also help in future during the contract period if there is sudden requirement for additional machines then deliveries can be expedited if the machines are with standard colour scheme</p>	<p>Terms &amp; Conditions applicable as per RFP.</p>
-----	-------------	-------	---	---	--

rollout. The successful bidders should provide a 3D model representation for visualization and clarity. The Bank's decision will be binding on the successful bidder. The final appearance will be decided by the Bank after taking into consideration the 3D model.

116	6.10.	Customer Interface / Fascia	Provide Text-to-Speech (TTS) support in English, Hindi and regional languages.	As per the IBA guidelines TTS support required for English & Hindi only not for regional languages.	Terms & Conditions applicable as per RFP.
116	6.12.0	Appendix C1	Terminal should report status (XFS) whether headphone is present/ not present in headphone jack, to the monitoring system	This functionality does not exist. Request Bank to remove this clause. Also Voice guidance is done based on Headphone insertion and there is no XFS coming to picture here.	Terms & Conditions applicable as per RFP.
116	6.12.0	Appendix C1	Terminal should report status (XFS) whether headphone is present/ not present in headphone jack, to the monitoring system	This functionality does not exist. Request Bank to remove this clause. Also Voice guidance is done based on Headphone insertion and there is no XFS coming to picture here.	Terms & Conditions applicable as per RFP.
116	6.12.0	Appendix-C1 → ATM Hardware Customer Interface/Fascia	Terminal should report status (XFS) whether headphone is present / not present in headphone jack, to the monitoring system	As per ATM OEM 2 - This functionality does not exist. Requesting Bank to amend this point suitably. Also Voice guidance is done based on Headphone insertion and hence, there is no requirement of XFS.	Terms & Conditions applicable as per RFP.
116	Appendix C1	6.12.0	Terminal should report status (XFS) whether headphone is present/ not present in headphone jack, to the monitoring system	This functionality does not exist. Request Bank to remove this clause. Also Voice guidance is done based on Headphone insertion and there is no XFS coming to picture here.	Terms & Conditions applicable as per RFP.

116	Appendix C1	6.12.0	Terminal should report status (XFS) whether headphone is present/ not present in headphone jack, to the monitoring system	This functionality does not exist. Request Bank to remove this clause. Also Voice guidance is done based on Headphone insertion and there is no XFS coming to picture here.	Terms & Conditions applicable as per RFP.
-----	-------------	--------	---	---	---

119	7.10.0	Appendix C1	<p>Cash Slot camera: A Camera should be present within the machine at the cash slot to capture the movement of cash from the presenter belt and final withdrawal by the customer. The camera should be capable of taking images and videos of the cash movement. The images and videos should be time stamped with Terminal ID, Masked Account &amp; Card no. etc. The images and videos should be saved in the Hard disk and should be capable of being pulled centrally. The OEM to provide the necessary drivers for the camera and assist in the integration with the Bank's MVS Software. The bank will require these images and videos for disputed transactions. Failure</p>	<p><b>Clarification:</b></p> <p>The software what manager the cameras will be provided by SBI/MVS exclusive.</p> <p>Under this situation, even the Bidder or OEM doesn't have any control if an image will be take or not.</p> <p>Under this limit of responsibility, please change this term as:</p> <p>.....The bank will require these images and videos for disputed transactions. Failure to provide the image and video AVAILABLES for the transactions required by the Bank, the Vendor to pay penalty of Rs.1,000/- or the disputed amount</p>	<p>Terms &amp; Conditions applicable as per RFP.</p>
-----	--------	-------------	---	--	--

		<p>to provide the image and video for the transactions required by the Bank, the Vendor to pay penalty of Rs.1,000/- or the disputed amount, whichever is higher. Bidder should provide required support to ATM application vendor (Solution provider) and obtain sign off from Bank before production movement</p>		
--	--	---	--	--



119	7.10.0	Appendix C1	<p>Cash Slot camera: A Camera should be present within the machine at the cash slot to capture the movement of cash from the presenter belt and final withdrawal by the customer. The camera should be capable of taking images and videos of the cash movement. The images and videos should be time stamped with Terminal ID, Masked Account &amp; Card no. etc. The images and videos should be saved in the Hard disk and should be capable of being pulled centrally. The OEM to provide the necessary drivers for the camera and assist in the integration with the Bank's MVS Software. The bank will require these images and videos for disputed transactions. Failure</p>	<p>Clarification:</p> <p>The software what manager the cameras will be provided by SBI/MVS exclusive.</p> <p>Under this situation, even the Bidder or OEM doesn't have any control if an image will be take or not.</p> <p>Under this limit of responsibility, please change this term as:</p> <p>.....The bank will require these images and videos for disputed transactions. Failure to provide the image and video AVAILABLES for the transactions required by the Bank, the Vendor to pay penalty of Rs.1,000/- or the disputed amount</p>	<p>Terms &amp; Conditions applicable as per RFP.</p>
-----	--------	-------------	---	---	--

		<p>to provide the image and video for the transactions required by the Bank, the Vendor to pay penalty of Rs.1,000/- or the disputed amount, whichever is higher. Bidder should provide required support to ATM application vendor (Solution provider) and obtain sign off from Bank before production movement</p>		
--	--	---	--	--

119	7.10.0	Appendix C1	<p>Cash Slot camera: A Camera should be present within the machine at the cash slot to capture the movement of cash from the presenter belt and final withdrawal by the customer. The camera should be capable of taking images and videos of the cash movement. The images and videos should be time stamped with Terminal ID, Masked Account &amp; Card no. etc. The images and videos should be saved in the Hard disk and should be capable of being pulled centrally. The OEM to provide the necessary drivers for the camera and assist in the integration with the Bank's MVS Software. The bank will require these images and videos for disputed transactions. Failure</p>	<p>Clarification:</p> <p>The software what manager the cameras will be provided by SBI/MVS exclusive.</p> <p>Under this situation, even the Bidder or OEM doesn't have any control if an image will be take or not.</p> <p>Under this limit of responsibility, please change this term as:</p> <p>.....The bank will require these images and videos for disputed transactions. Failure to provide the image and video AVAILABLES for the transactions required by the Bank, the Vendor to pay penalty of Rs.1,000/- or the disputed amount</p>	<p>Terms &amp; Conditions applicable as per RFP.</p>
-----	--------	-------------	---	---	--

		<p>to provide the image and video for the transactions required by the Bank, the Vendor to pay penalty of Rs.1,000/- or the disputed amount, whichever is higher. Bidder should provide required support to ATM application vendor (Solution provider) and obtain sign off from Bank before production movement</p>		
--	--	---	--	--

119	7.10.0	Appendix C1	<p>Cash Slot camera: A Camera should be present within the machine at the cash slot to capture the movement of cash from the presenter belt and final withdrawal by the customer. The camera should be capable of taking images and videos of the cash movement. The images and videos should be time stamped with Terminal ID, Masked Account &amp; Card no. etc. The images and videos should be saved in the Hard disk and should be capable of being pulled centrally. The OEM to provide the necessary drivers for the camera and assist in the integration with the Bank's MVS Software. The bank will require these images and videos for disputed transactions. Failure</p>	<p>Clarification:</p> <p>The software what manager the cameras will be provided by SBI/MVS exclusive.</p> <p>Under this situation, even the Bidder or OEM doesn't have any control if an image will be take or not.</p> <p>Under this limit of responsibility, please change this term as:</p> <p>.....The bank will require these images and videos for disputed transactions. Failure to provide the image and video AVAILABLES for the transactions required by the Bank, the Vendor to pay penalty of Rs.1,000/- or the disputed amount</p>	<p>Terms &amp; Conditions applicable as per RFP.</p>
-----	--------	-------------	---	---	--

		<p>to provide the image and video for the transactions required by the Bank, the Vendor to pay penalty of Rs.1,000/- or the disputed amount, whichever is higher. Bidder should provide required support to ATM application vendor (Solution provider) and obtain sign off from Bank before production movement</p>		
--	--	---	--	--

119	7.10.0	Appendix-C1 → ATM Hardware Integrated ATM Surveillance Solution (Camera)	Cash Slot camera: A Camera should be present within the machine at the cash slot to capture the movement of cash from the presenter belt and final withdrawal by the customer. The camera should be capable of taking images and videos of the cash movement. The images and videos should be time stamped with Terminal ID, Masked Account & Card no. etc. The images and videos should be saved in the Hard disk and should be capable of being pulled centrally. The OEM to provide the necessary drivers for the camera and assist in the integration with the Bank's MVS Software. The bank will require these images and videos for disputed transactions. Failure	<p>We request Bank to check with the OEM on the possibility/availability of video capturing machoism for the cash movement.</p> <p>Clarification on below point sought by OEM 1 :</p> <p>The software what manager the cameras will be provided by SBI/MVS exclusive.</p> <p>Under this situation, even the Bidder or OEM doesn't have any control if an image will be take or not.</p> <p>Under this limit of responsibility, please change this term as:</p> <p>.....The bank will require these images and videos for disputed transactions. Failure to provide the image and video AVAILABLES for the transactions required by the Bank, the Vendor to pay penalty of Rs.1,000/- or the disputed amount</p>	Terms & Conditions applicable as per RFP.
-----	--------	--	--	---	---

		<p>to provide the image and video for the transactions required by the Bank, the Vendor to pay penalty of Rs.1,000/- or the disputed amount, whichever is higher. Bidder should provide required support to ATM application vendor (Solution provider) and obtain sign off from Bank before production movement.</p>		
--	--	--	--	--



119	7.10.0	<p>Cash Slot camera: A Camera should be present within the machine at the cash slot to capture the movement of cash from the presenter belt and final withdrawal by the customer. The camera should be capable of taking images and videos of the cash movement. The images and videos should be time stamped with Terminal ID, Masked Account &amp; Card no. etc. The images and videos should be saved in the Hard disk and should be capable of being pulled centrally. The OEM to provide the necessary drivers for the camera and assist in the integration with the Bank's MVS Software. The bank will require these images and videos for disputed transactions. Failure</p>	<p><b>Clarification:</b></p> <p>The ATM may have the camera hardware however images/videos are managed by the software which will be provided by SBI/MVS.</p> <p>Under this situation, even the Bidder or OEM doesn't have any control if an image will be take or not.</p> <p>Under this limit of responsibility, please waive of the penalty of Rs 1000/- or the disputed amount.</p>	<p>Terms &amp; Conditions applicable as per RFP.</p>
-----	--------	---	---	--

		<p>to provide the image and video for the transactions required by the Bank, the Vendor to pay penalty of Rs.1,000/- or the disputed amount, whichever is higher. Bidder should provide required support to ATM application vendor (Solution provider) and obtain sign off from Bank before production movement</p>		
--	--	---	--	--

119	7.11.0	Appendix C1	ATM must be capable of performing under extreme conditions. Temperature: 0 degree Celsius to +50 degree Celsius (Without Air Conditioner) Relative Humidity: 5 to 95 % (Without Air Conditioner)	The requested ATM is a lobby unit which follow the lobby environment condition 10 to 40C and 20 to 80RH. Request Bank to amend this clause accordingly	Terms & Conditions applicable as per RFP.
119	7.11.0	Appendix C1	ATM must be capable of performing under extreme conditions. Temperature: 0 degree Celsius to +50 degree Celsius (Without Air Conditioner) Relative Humidity: 5 to 95 % (Without Air Conditioner)	The requested ATM is a lobby unit which follow the lobby environment condition 10 to 40C and 20 to 80RH. Request Bank to amend this clause accordingly	Terms & Conditions applicable as per RFP.
119	7.11.0	Appendix-C1 → ATM Hardware	ATM must be capable of performing under extreme conditions. Temperature: 0 degree Celsius to +50 degree Celsius (Without Air Conditioner) Relative Humidity: 5 to 95 % (Without Air Conditioner)	We would request Bank to amend this clause as Temperature: 0 degree Celsius to +45 degree Celsius (Without Air Conditioner) Relative Humidity : 5 to 85 % (Without Air Conditioner)	Terms & Conditions applicable as per RFP.

119	7.11.0	Appendix-C1 → ATM Hardware ATM	ATM must be capable of performing under extreme conditions. Temperature: 0 degree Celsius to +50 degree Celsius (Without Air Conditioner) Relative Humidity: 5 to 95 % (Without Air Conditioner)	As per ATM OEM 2 - The requested ATM is a lobby unit which follow the lobby environment condition 10 to 40C and 20 to 80RH. Requesting the Bank to amend this point, accordingly.	Terms & Conditions applicable as per RFP.
119	7.11.0	ATM must be capable of performing under extreme conditions. Temperature: 0 degree Celsius to +50 degree Celsius (Without Air Conditioner) Relative Humidity: 5 to 95 % (Without Air Conditioner)	ATM must be capable of performing under extreme conditions. Temperature: 0 degree Celsius to +50 degree Celsius (Without Air Conditioner) Relative Humidity: 5 to 95 % (Without Air Conditioner)	We would request Bank to amend this clause as Temperature: 0 degree Celsius to +45 degree Celsius (Without Air Conditioner) Relative Humidity : 5 to 85 % (Without Air Conditioner)	Terms & Conditions applicable as per RFP.

119	Appendix C1	7.11.0	ATM must be capable of performing under extreme conditions. Temperature: 0 degree Celsius to +50 degree Celsius (Without Air Conditioner) Relative Humidity: 5 to 95 % (Without Air Conditioner)	The requested ATM is a lobby unit which follow the lobby environment condition 10 to 40C and 20 to 80RH. Request Bank to amend this clause accordingly	Terms & Conditions applicable as per RFP.
119	Appendix C1	7.11.0	ATM must be capable of performing under extreme conditions. Temperature: 0 degree Celsius to +50 degree Celsius (Without Air Conditioner) Relative Humidity: 5 to 95 % (Without Air Conditioner)		Terms & Conditions applicable as per RFP.

119		Integrated ATM Surveillance Solution (Camera)	Failure to provide the image and video for the transactions required by the Bank, the Vendor to pay penalty of Rs.1,000/- or the disputed amount, whichever is higher. Bidder should provide required support to ATM application vendor (Solution provider) and obtain sign off from Bank before production movement.	The Bidder request the Bank to reduce this penalty to Rs 100	Terms & Conditions applicable as per RFP.
120	7.13.0	Appendix C1	The Solution should be capable of notifying the Switch in case the DVSS camera is covered/ blocked by any means so that the Cash Dispenser does not dispense cash.	DVSS camera do send device message however if some one blocks the camera there is no provision to notify to ATM switch / monitoring system hence request bank to delete this clause. Also this would be part of the E-surveillance requirement implemented by the Bank	Terms & Conditions applicable as per RFP.

120	7.13.0	Appendix C1	The Solution should be capable of notifying the Switch in case the DVSS camera is covered/ blocked by any means so that the Cash Dispenser does not dispense cash.	DVSS camera do send device message however if some one blocks the camera there is no provision to notify to ATM switch / monitoring system hence request bank to delete this clause. Also this would be part of the E-surveillance requirement implemented by the Bank	Terms & Conditions applicable as per RFP.
120	7.13.0	Appendix-C1 → ATM Hardware ATM	The Solution should be capable of notifying the Switch in case the DVSS camera is covered / blocked by any means so that the Cash Dispenser does not dispense cash.	We request Bank to check with the OEM on the possibility of said point.  As per ATM OEM 2 - DVSS camera do send device message, however if some one blocks the camera there is no provision to notify to ATM switch / monitoring system. requesting the Bank to amend the point suitably.	Terms & Conditions applicable as per RFP.
120	8.3.0	DES Chip / Security	ATM should be with in-built security features to trigger alarm in case of fire, hammering / tilting of the machine	(a) Will this be in addition to ESS alarm and in which center monitoring of this will be done? Request bank to clarify	Terms & Conditions applicable as per RFP.

120	Appendix C1	7.13.0	The Solution should be capable of notifying the Switch in case the DVSS camera is covered/ blocked by any means so that the Cash Dispenser does not dispense cash.	DVSS camera do send device message however if some one blocks the camera there is no provision to notify to ATM switch / monitoring system hence request bank to delete this clause. Also this would be part of the E-surveillance requirement implemented by the Bank	Terms & Conditions applicable as per RFP.
120	Appendix C1	7.13.0	The Solution should be capable of notifying the Switch in case the DVSS camera is covered/ blocked by any means so that the Cash Dispenser does not dispense cash.	DVSS camera do send device message however if some one blocks the camera there is no provision to notify to ATM switch / monitoring system hence request bank to delete this clause. Also this would be part of the E-surveillance requirement implemented by the Bank	Terms & Conditions applicable as per RFP.



121	9.2.0	ATM HW	<p>Equipment to be provided should be already certified and working on Base 24 switch with full EMV compliance. Should be capable of connecting to the existing ATM Switch (Base24) or any other Switch introduced by the Bank in future, using existing device handlers (NDC version 4.0/ D912) at no additional cost to the Bank. One of the following is required to be uploaded:</p> <p>(a) Self-declaration of OEM required along with completion of EMV certification already obtained under Bank's MVS application- If the proposed model of endpoint is currently working at SBI with EMV compliance having valid L1 &amp; L2 certificate, or</p> <p>(b) Certificate from any scheduled</p>	<p><u>As the Bank wants to implement MVS and MVS comes with L2,</u></p> <p>Request Bank to modify the clause (c) as below by relaxing time for L2 certification requirement for windows native application:</p> <p>Equipment to be provided should be already certified and working on Base 24 switch with full EMV compliance. Should be capable of connecting to the existing ATM Switch (Base24) or any other Switch introduced by the Bank in future, using existing device handlers (NDC version 4.0/ D912) at no additional cost to the Bank. One of the following is required to be uploaded:</p> <p>(a) Self-declaration of OEM required along with completion of EMV certification already obtained under Bank's MVS application- If the proposed model of endpoint is currently working at SBI with EMV compliance having valid L1 &amp; L2 certificate, or</p> <p>(b) Certificate from any scheduled commercial bank certifying that the proposed model offered under this RFP is</p>	<p>Terms &amp; Conditions applicable as per RFP.</p>
-----	-------	--------	---	--	--

commercial bank certifying that the proposed model offered under this RFP is Tech live on its Base24 switch with EMV compliance having valid L1 & L2 certificate and working satisfactory. or  
(c) If the proposed model is not working at SBI or any other Banks in India, Bidder to provide switch certification along with valid L1 & L2 certificates, with in a period of 15 days of LOI, to the Bank. Bank may facilitate for the certification with Base24 switch, for which a fee of Rs 20 lacs will be charged per model by the Bank from the Bidder. In case of both (b) & (c), since EMV certification is required to be done for the Bank's MVS as L3 application for all

Tech live on its Base24 switch with EMV compliance having valid L1 & L2 certificate and working satisfactory. or  
(c) If the proposed model is not working at SBI or any other Banks in India, Bidder to provide switch certification along with valid L1 certificates, with in a period of 15 days of LOI to the Bank, and L2 certificates whenever Bank wants to implement OEM's native application. Bank may facilitate for the certification with Base24 switch, for which a fee of Rs 20 lacs will be charged per model by the Bank from the Bidder. In case of both (b) & (c), since EMV certification is required to be done for the Bank's MVS as L3 application for all the card networks interfaced by Bank, certification cost of Rs. 15 lacs shall be charged per model by the Bank from the Bidder.

		<p>the card networks interfaced by Bank, certification cost of Rs. 15 lacs shall be charged per model by the Bank from the Bidder.</p>		
--	--	--	--	--

121	9.2.0	ATM HW	<p>Equipment to be provided should be already certified and working on Base 24 switch with full EMV compliance. Should be capable of connecting to the existing ATM Switch (Base24) or any other Switch introduced by the Bank in future, using existing device handlers (NDC version 4.0/ D912) at no additional cost to the Bank. One of the following is required to be uploaded:</p> <p>(a) Self-declaration of OEM required along with completion of EMV certification already obtained under Bank's MVS application- If the proposed model of endpoint is currently working at SBI with EMV compliance having valid L1 &amp; L2 certificate, or</p> <p>(b) Certificate from any scheduled</p>	<p><u>As the Bank wants to implement MVS and MVS comes with L2,</u></p> <p>Request Bank to modify the clause (c) as below by relaxing time for L2 certification requirement for windows native application:</p> <p>Equipment to be provided should be already certified and working on Base 24 switch with full EMV compliance. Should be capable of connecting to the existing ATM Switch (Base24) or any other Switch introduced by the Bank in future, using existing device handlers (NDC version 4.0/ D912) at no additional cost to the Bank. One of the following is required to be uploaded:</p> <p>(a) Self-declaration of OEM required along with completion of EMV certification already obtained under Bank's MVS application- If the proposed model of endpoint is currently working at SBI with EMV compliance having valid L1 &amp; L2 certificate, or</p> <p>(b) Certificate from any scheduled commercial bank certifying that the proposed model offered under this RFP is</p>	<p>Terms &amp; Conditions applicable as per RFP.</p>
-----	-------	--------	---	--	--

commercial bank certifying that the proposed model offered under this RFP is Tech live on its Base24 switch with EMV compliance having valid L1 & L2 certificate and working satisfactory. or  
(c) If the proposed model is not working at SBI or any other Banks in India, Bidder to provide switch certification along with valid L1 & L2 certificates, with in a period of 15 days of LOI, to the Bank. Bank may facilitate for the certification with Base24 switch, for which a fee of Rs 20 lacs will be charged per model by the Bank from the Bidder. In case of both (b) & (c), since EMV certification is required to be done for the Bank's MVS as L3 application for all

Tech live on its Base24 switch with EMV compliance having valid L1 & L2 certificate and working satisfactory. or  
(c) If the proposed model is not working at SBI or any other Banks in India, Bidder to provide switch certification along with valid L1 certificates, with in a period of 15 days of LOI to the Bank, and L2 certificates whenever Bank wants to implement OEM's native application. Bank may facilitate for the certification with Base24 switch, for which a fee of Rs 20 lacs will be charged per model by the Bank from the Bidder. In case of both (b) & (c), since EMV certification is required to be done for the Bank's MVS as L3 application for all the card networks interfaced by Bank, certification cost of Rs. 15 lacs shall be charged per model by the Bank from the Bidder.

		<p>the card networks interfaced by Bank, certification cost of Rs. 15 lacs shall be charged per model by the Bank from the Bidder.</p>		
--	--	--	--	--

123	11.1.0	Appendix C1	<p>Capable of supporting any Multi-Vendor Software Application procured/available with the Bank. Bidder is required to support other MVS also in case Bank changes its current MVS during the contract period. If Bank procures new MVS Software to replace the existing MVS Software, Bank shall pay the Testing / Professional Charges of Rs. 12 lakh (for ATMs) to the bidder after successful testing and implementation on each machine supplied by the Bidder. No visit charges shall be paid to the bidder for implementing the new MVS Solution.</p>	<p>As we do not have the visibility to the future MVS bank will select, request bank to keep this out of scope and to be mutually discussed between bank and bidder at that time.</p>	<p>Terms &amp; Conditions applicable as per RFP.</p>
-----	--------	-------------	--	---	--

123	11.1.0	Appendix C1	<p>Capable of supporting any Multi-Vendor Software Application procured/available with the Bank. Bidder is required to support other MVS also in case Bank changes its current MVS during the contract period. If Bank procures new MVS Software to replace the existing MVS Software, Bank shall pay the Testing / Professional Charges of Rs. 12 lakh (for ATMs) to the bidder after successful testing and implementation on each machine supplied by the Bidder. No visit charges shall be paid to the bidder for implementing the new MVS Solution.</p>	<p>As we do not have the visibility to the future MVS bank will select, request bank to keep this out of scope and to be mutually discussed between bank and bidder at that time.</p>	<p>Terms &amp; Conditions applicable as per RFP.</p>
-----	--------	-------------	--	---	--



123	11.1.0	Appendix-C1 → ATM Hardware SOFTWARE	Capable of supporting any Multi-Vendor Software Application procured/available with the Bank. Bidder is required to support other MVS also in case Bank changes its current MVS during the contract period. If Bank procures new MVS Software to replace the existing MVS Software, Bank shall pay the Testing / Professional Charges of Rs. 12 lakh (for ATMs) to the bidder after successful testing and implementation on each machine supplied by the Bidder. No visit charges shall be paid to the bidder for implementing the new MVS Solution.	As per ATM OEM 2 - As we do not have the visibility to the future MVS, bank may select. Requesting the Bank to keep this point out of the scope and to be mutually discussed between bank and bidder during its implication.	Terms & Conditions applicable as per RFP.
-----	--------	-------------------------------------	---	--	---

123	Appendix C1	11.1.0	<p>Capable of supporting any Multi-Vendor Software Application procured/available with the Bank. Bidder is required to support other MVS also in case Bank changes its current MVS during the contract period. If Bank procures new MVS Software to replace the existing MVS Software, Bank shall pay the Testing / Professional Charges of Rs. 12 lakh (for ATMs) to the bidder after successful testing and implementation on each machine supplied by the Bidder. No visit charges shall be paid to the bidder for implementing the new MVS Solution.</p>	<p>As we do not have the visibility to the future MVS bank will select, request bank to keep this out of scope and to be mutually discussed between bank and bidder at that time.</p>	<p>Terms &amp; Conditions applicable as per RFP.</p>
-----	-------------	--------	--	---	--

123	Appendix C1	11.1.0	<p>Capable of supporting any Multi-Vendor Software Application procured/available with the Bank. Bidder is required to support other MVS also in case Bank changes its current MVS during the contract period. If Bank procures new MVS Software to replace the existing MVS Software, Bank shall pay the Testing / Professional Charges of Rs. 12 lakh (for ATMs) to the bidder after successful testing and implementation on each machine supplied by the Bidder. No visit charges shall be paid to the bidder for implementing the new MVS Solution.</p>	<p>As we do not have the visibility to the future MVS bank will select, request bank to keep this out of scope and to be mutually discussed between bank and bidder at that time.</p>	<p>Terms &amp; Conditions applicable as per RFP.</p>
-----	-------------	--------	--	---	--

123	Appendix C1-11.1.0	Appendix-C1 → ATM Hardware	If Bank procures new Software to replace the existing MVS Software, Bank shall pay the Testing /Professional Charges of Rs. 12 lakh (for ATMs) to the bidder	Professional charges for Testing New Software is very low, we request bank to modify this clause as mutuallly agreed cost.	Terms & Conditions applicable as per RFP.
123	Appendix C1-11.1.0	If Bank procures new Software to replace the existing MVS Software, Bank shall pay the Testing /Professional Charges of Rs. 12 lakh (for ATMs) to the bidder	If Bank procures new Software to replace the existing MVS Software, Bank shall pay the Testing /Professional Charges of Rs. 12 lakh (for ATMs) to the bidder	Professional charges for Testing New Software is very low, we request bank to modify this clause as mutuallly agreed cost.	Terms & Conditions applicable as per RFP.

124	13.4.0	<p>ATM should have Integrated Power Management Solution. The ATM software must be capable of interfacing with the Bank's UPS systems and query the battery status, in-line power and temperature, taking the machine out of service if the battery capacity is too low, perform scheduled power offs and automatically start up at the configured date and time. The solution must shut down gracefully to allow completion of the ongoing transaction in the event of complete battery discharge. The above power management functionality must be controllable remotely. In this situation, ATM should have the capability of generating message</p>	<p>ATM should have capacity of generating msg of low battery – this will require changes in the ATM application.</p>	<p>Terms &amp; Conditions applicable as per RFP.</p>
-----	--------	--	--	--

		of low battery status and should send the same to the switch.		
--	--	---	--	--

124	14.1.0	Maintenance	Bidder should provide hardware, software and MIS (Keyboard, Mouse etc.) for day-to-day operations whenever required for the maintenance of machines.	Requesting bank to change the Keyboard and Mouse as optional item as all OEMS does not required keyboard/mouse for day to day operations.	<b>CORRIGENDUM:</b> <del>Bidder should provide hardware, software and MIS (Keyboard, Mouse etc.) for day-to-day operations whenever required for the maintenance of machines.</del>
124	15.1.0	Appendix-C	Bidder to integrate – where required -- the alarm sensors of the ATM to the branch siren/hooter without any additional cost to Bank.	We request bank to remove the scope of integration of sensor to other vendor device. This will create future issue. All these machines are replacement with Offsite ATM and we believe no existing device of branch installed at site.	Terms & Conditions applicable as per RFP.
124	15.1.0		Bidder to integrate – where required -- the alarm sensors of the ATM to the branch siren/hooter without any additional cost to Bank.	Alarm sensors to be integrated with Branch hooter , is there a compatible make /model suggested by bank?	Terms & Conditions applicable as per RFP.
124	15.3.0	Appendix C1	ATM should have PIN pad shield covering all three sides to avoid shoulder surfing and capture by the external cameras.	We recommend bank to go with standard EPP design without additional cover to help preventing any implant of hidden camera. PIN shields are prone for frauds	Terms & Conditions applicable as per RFP.

124	15.3.0	Appendix C1	ATM should have PIN pad shield covering all three sides to avoid shoulder surfing and capture by the external cameras.	We recommend bank to go with standard EPP design without additional cover to help preventing any implant of hidden camera. PIN shields are prone for frauds	Terms & Conditions applicable as per RFP.
124	15.3.0	Appendix-C1 → ATM Hardware Customer Interface/Fascia	ATM should have PIN pad shield covering all three sides to avoid shoulder surfing and capture by the external cameras.	As per ATM OEM 2 - We recommend bank to go with standard EPP design without additional cover to help preventing any implant of hidden camera. As PIN shields are prone to frauds.	Terms & Conditions applicable as per RFP.
124	Appendix C1	15.3.0	ATM should have PIN pad shield covering all three sides to avoid shoulder surfing and capture by the external cameras.	We recommend bank to go with standard EPP design without additional cover to help preventing any implant of hidden camera. PIN shields are prone for frauds	Terms & Conditions applicable as per RFP.
124	Appendix C1	15.3.0	ATM should have PIN pad shield covering all three sides to avoid shoulder surfing and capture by the external cameras.	We recommend bank to go with standard EPP design without additional cover to help preventing any implant of hidden camera. PIN shields are prone for frauds	Terms & Conditions applicable as per RFP.



124	Appendix C1	16.1.0	<p>The NFC contactless module with support contactless card Integration (hardware and Software) supporting up to ISO 14443 Type A/Type B, Mi Fare ISO 21481 and ISO/IEC 18092 or higher. In case any new guidelines or the regulator mandates newer specifications, the service provider should provide required support for hardware /software without any additional cost to the Bank during the contact period.</p>	<p>The bidder will provide the NFC Hardware as per the required specification at the the time of bid submission. Subsequent change in the NFC standards resulting in change in hardware will be at a mutually agreed incremental price .</p>	<p>Terms &amp; Conditions applicable as per RFP.</p>
-----	-------------	--------	--	--	--

125	16.1.0	Appendix C1	<p>The NFC contactless module with support contactless card Integration (hardware and Software) supporting upto ISO 14443 Type A/Type B, Mi Fare ISO 21481 and ISO/IEC 18092 or higher. In case any new guidelines or the regulator mandates newer specifications, the service provider should provide required support for hardware /software without any additional cost to the Bank during the contact period.</p>	<p>The bidder will provide the NFC Hardware as per the required specification at the the time of bid submission. Subsequent change in the NFC standards resulting in change in hardware will be at a mutually agreed incremental price .</p>	<p>Terms &amp; Conditions applicable as per RFP.</p>
-----	--------	-------------	---	--	--

125	16.1.0	Appendix C2	<p>The NFC contactless module with support contactless card Integration (hardware and Software) supporting upto ISO 14443 Type A/Type B, Mi Fare ISO 21481 and ISO/IEC 18092 or higher. In case any new guidelines or the regulator mandates newer specifications, the service provider should provide required support for hardware /software without any additional cost to the Bank during the contact period.</p>	<p>The bidder will provide the NFC Hardware as per the required specification at the the time of bid submission. Subsequent change in the NFC standards resulting in change in hardware will be at a mutually agreed incremental price .</p>	<p>Terms &amp; Conditions applicable as per RFP.</p>
-----	--------	-------------	---	--	--

125	16.1.0	Appendix-C1 → ATM Hardware Contactless Card Reader	The NFC contactless module with support contactless card Integration (hardware and Software) supporting upto ISO 14443 Type A/Type B, Mi Fare ISO 21481 and ISO/IEC 18092 or higher. In case any new guidelines or the regulator mandates newer specifications, the service provider should provide required support for hardware /software without any additional cost to the Bank during the contact period.	As per ATM OEM 2 - We can provide the NFC Hardware as per the required specification at the time of bid submission. However, any subsequent change in the NFC standards, may result in change in hardware. Hence, we request the Bank for its mutual discussion, for an agreed incremental price.	Terms & Conditions applicable as per RFP.
125	16.4.0	Appendix C1	Should provide necessary certificates/approvals from VISA, Master Card, Amex, Union Pay, Rupay, Discover including TQM(PCD) certificates. On expiry of certificate, it should be replaced with valid certificate at no additional cost to the Bank.	This capability is controlled by the ATM application, not by the XFS platform or the hardware. Request the bank to acknowledge the same.	Terms & Conditions applicable as per RFP.

125	16.4.0	Appendix C1	Should provide necessary certificates/approvals from VISA, Master Card, Amex, Union Pay, Rupay, Discover including TQM(PCD) certificates. On expiry of certificate, it should be replaced with valid certificate at no additional cost to the Bank.	This capability is controlled by the ATM application, not by the XFS platform or the hardware. Request the bank to acknowledge the same.	Terms & Conditions applicable as per RFP.
125	16.4.0	Appendix-C1 → ATM Hardware Contactless Card Reader	Should provide necessary certificates/approvals from VISA, Master Card, Amex, Union Pay, Rupay, Discover including TQM(PCD) certificates. On expiry of certificate, it should be replaced with valid certificate at no additional cost to the Bank.	As per ATM OEM 2 - This capability is controlled by the ATM application, not by the XFS platform or the hardware. Request the bank to acknowledge the same.	Terms & Conditions applicable as per RFP.

125	Appendix C1	16.4.0	Should provide necessary certificates/approvals from VISA, Master Card, Amex, Union Pay, Rupay, Discover including TQM(PCD) certificates. On expiry of certificate, it should be replaced with valid certificate at no additional cost to the Bank.	This capability is controlled by the ATM application, not by the XFS platform or the hardware. Request the bank to acknowledge the same.	Terms & Conditions applicable as per RFP.
125	Appendix C1	16.4.0	Should provide necessary certificates/approvals from VISA, Master Card, Amex, Union Pay, Rupay, Discover including TQM(PCD) certificates. On expiry of certificate, it should be replaced with valid certificate at no additional cost to the Bank.	This capability is controlled by the ATM application, not by the XFS platform or the hardware. Request the bank to acknowledge the same.	Terms & Conditions applicable as per RFP.

125	Appendix C2	16.1.0	<p>The NFC contactless module with support contactless card Integration (hardware and Software) supporting upto ISO 14443 Type A/Type B, Mi Fare ISO 21481 and ISO/IEC 18092 or higher. In case any new guidelines or the regulator mandates newer specifications, the service provider should provide required support for hardware /software without any additional cost to the Bank during the contact period.</p>	<p>The bidder will provide the NFC Hardware as per the required specification at the the time of bid submission. Subsequent change in the NFC standards resulting in change in hardware will be at a mutually agreed incremental price .</p>	<p>Terms &amp; Conditions applicable as per RFP.</p>
126	18.1.0	Appendix-C1 → ATM Hardware Bar Code Scanner	<p>ATM should have capability to integrate 1D/2D barcode and QR code scanner for future requirements of scanning codes from mobile phones by simply attaching a reader, compliant with Code128, Code39, QR Code standards.</p>	<p>As per ATM OEM 1 - Please Clarify/Confirm: The ATM shall have capability only. In case SBI will require this feature the Hardware cost will be under mutual discussion.</p>	<p>Terms &amp; Conditions applicable as per RFP.</p>

126	18.2.0	Appendix C1	ATM should have capability to integrate 1D/2D barcode and QR code scanner for future requirements of scanning codes from mobile phones by simply attaching a reader, compliant with Code128, Code39, QR Code standards.	<p>Please Clarify/Confirm:</p> <p>The EPS/ATM shall have capability only. In case SBI will require this feature the Hardware cost will be under mutual discussion.</p> <p>Please confirm.</p>	Terms & Conditions applicable as per RFP.
126	18.2.0	Appendix C1	ATM should have capability to integrate 1D/2D barcode and QR code scanner for future requirements of scanning codes from mobile phones by simply attaching a reader, compliant with Code128, Code39, QR Code standards.	<p>Please Clarify/Confirm:</p> <p>The EPS/ATM shall have capability only. In case SBI will require this feature the Hardware cost will be under mutual discussion.</p>	Terms & Conditions applicable as per RFP.
126	18.2.0	Appendix C1	ATM should have capability to integrate 1D/2D barcode and QR code scanner for future requirements of scanning codes from mobile phones by simply attaching a reader, compliant with Code128,	<p>Please Clarify/Confirm:</p> <p>The EPS/ATM shall have capability only. In case SBI will require this feature the Hardware cost will be under mutual discussion.</p> <p>Please confirm.</p>	Terms & Conditions applicable as per RFP.



			Code39, QR Code standards.		
126	18.2.0	Appendix C1	ATM should have capability to integrate 1D/2D barcode and QR code scanner for future requirements of scanning codes from mobile phones by simply attaching a reader, compliant with Code128, Code39, QR Code standards.	<p>Please Clarify/Confirm:</p> <p>The EPS/ATM shall have capability only. In case SBI will require this feature the Hardware cost will be under mutual discussion.</p> <p>Please confirm.</p>	Terms & Conditions applicable as per RFP.
126	18.2.0		ATM should have capability to integrate 1D/2D barcode and QR code scanner for future requirements of scanning codes from mobile phones by simply attaching a reader, compliant with Code128, Code39, QR Code standards.	<p>Please Clarify/Confirm:</p> <p>The EPS/ATM shall have capability only. In case SBI will require this feature which may require a Hardware upgrade, this will be at an extra cost to be decided mutually.</p>	Terms & Conditions applicable as per RFP.

126	19.5.0	Appendix C1	L-3 Certification with MasterCard, Visa, Rupay or any other provider to be done by the service provider	L3 Certification has to be done by the Bank (MVS Vendor). Request to Bank to acknowledge the same	Terms & Conditions applicable as per RFP.
126	19.5.0	Appendix C2	L-3 Certification with MasterCard, Visa, Rupay or any other provider to be done by the service provider	L3 Certification has to be done by the Bank (MVS Vendor). Request to Bank to acknowledge the same	Terms & Conditions applicable as per RFP.
126	19.5.0	Appendix-C1 → ATM Hardware Software Testing	L-3 Certification with MasterCard, Visa, Rupay or any other provider to be done by the service provider	As per ATM OEM 2 - L3 Certification has to be done by the Bank (MVS Vendor). Requesting Bank to acknowledge the same	Terms & Conditions applicable as per RFP.
126	Appendix C1	19.5.0	L-3 Certification with MasterCard, Visa, Rupay or any other provider to be done by the service provider	L3 Certification has to be done by the Bank (MVS Vendor). Request to Bank to acknowledge the same	Terms & Conditions applicable as per RFP.
126	Appendix C2	19.5.0	L-3 Certification with MasterCard, Visa, Rupay or any other provider to be done by the service provider	L3 Certification has to be done by the Bank (MVS Vendor). Request to Bank to acknowledge the same	Terms & Conditions applicable as per RFP.

126		Software Testing	L-3 Certification with MasterCard, Visa, Rupay or any other provider to be done by the service provider		Terms & Conditions applicable as per RFP.
127	21.1.0	Appendix C1	Co-ordinated LED Lights Indicators at Card Reader, Cash slot dispenser, Receipt printer, The LED Lights at these places will blink accordingly during the course of transaction attracting the attention of the customer to that part of the machine. These coordinated LED lights but can be explored at keypad area and FDK (if present) by the OEMs in future. Bank would like to have backlit keypad and FDK for its future procurements.	We request here to limit the LEDs to standard LEDs like Cash Dispense, Card Reader and Receipt. Also FDK as a module is optional anyway and not to be used from voice guidance perspective	Terms & Conditions applicable as per RFP.

127	21.1.0	Appendix C1	<p>Co-ordinated LED Lights Indicators at Card Reader, Cash slot dispenser, Receipt printer, The LED Lights at these places will blink accordingly during the course of transaction attracting the attention of the customer to that part of the machine. These coordinated LED lights but can be explored at keypad area and FDK (if present) by the OEMs in future. Bank would like to have backlit keypad and FDK for its future procurements.</p>	<p>We request here to limit the LEDs to standard LEDs like Cash Dispense, Card Reader and Receipt. Also FDK as a module is optional anyway and not to be used from voice guidance perspective</p>	<p>Terms &amp; Conditions applicable as per RFP.</p>
-----	--------	-------------	--	---	--

127	21.1.0	Appendix-C1 → ATM Hardware Hardware	Co-ordinated LED Lights Indicators at Card Reader, Cash slot dispenser, Receipt printer, The LED Lights at these places will blink accordingly during the course of transaction attracting the attention of the customer to that part of the machine. These coordinated LED lights but can be explored at keypad area and FDK (if present) by the OEMs in future. Bank would like to have backlit keypad and FDK for its future procurements.	As per ATM OEM 2 - We request Bank to limit the LEDs to standard LEDs like Cash Dispense, Card Reader and Receipt. Also FDK as a module is optional anyway and not to be used from voice guidance perspective	Terms & Conditions applicable as per RFP.
127	22.0.0	Interface for Banking software and & Switch Connectivity	Vendor to provide utility for converting the Cash Dispenser files, containing transaction details, into ASCII format.	All dispenser files can able to validated/Verified by vendor as and when requested by bank team. Please provide more clarity which files need to be convert into ASCII and purpose of the requireemnt.	Terms & Conditions applicable as per RFP.

127	Appendix C1	21.1.0	<p>Co-ordinated LED Lights Indicators at Card Reader, Cash slot dispenser, Receipt printer, The LED Lights at these places will blink accordingly during the course of transaction attracting the attention of the customer to that part of the machine. These coordinated LED lights but can be explored at keypad area and FDK (if present) by the OEMs in future. Bank would like to have backlit keypad and FDK for its future procurements.</p>	<p>We request here to limit the LEDs to standard LEDs like Cash Dispense, Card Reader and Receipt. Also FDK as a module is optional anyway and not to be used from voice guidance perspective</p>	<p>Terms &amp; Conditions applicable as per RFP.</p>
-----	-------------	--------	--	---	--

127	Appendix C1	21.1.0	<p>Co-ordinated LED Lights Indicators at Card Reader, Cash slot dispenser, Receipt printer, The LED Lights at these places will blink accordingly during the course of transaction attracting the attention of the customer to that part of the machine. These coordinated LED lights but can be explored at keypad area and FDK (if present) by the OEMs in future. Bank would like to have backlit keypad and FDK for its future procurements.</p>	<p>We request here to limit the LEDs to standard LEDs like Cash Dispense, Card Reader and Receipt. Also FDK as a module is optional anyway and not to be used from voice guidance perspective</p>	<p>Terms &amp; Conditions applicable as per RFP.</p>
-----	-------------	--------	--	---	--

128	24.0.0	Appendix C1	<p>The machine should have a self-powered GPS device within the machine, so that the machine can be tracked in case it has been uprooted and taken away. The GPS device should be capable of providing longitude and latitude coordinates.</p> <p>The GPS device should be integrated with the XFS layer so that its coordinates' data can be read through MVS.</p>	This clause should be deleted	<p>Terms &amp; Conditions applicable as per RFP.</p> <p>Clarification: Optional.</p>
128	24.0.0	Appendix C1	<p>The machine should have a self-powered GPS device within the machine, so that the machine can be tracked in case it has been uprooted and taken away. The GPS device should be capable of providing longitude and latitude coordinates.</p> <p>The GPS device should be integrated with the XFS layer so that its coordinates'</p>	This clause should be deleted	<p>Terms &amp; Conditions applicable as per RFP.</p> <p>Clarification: Optional.</p>



			data can be read through MVS.		
128	24.0.0	Appendix-C1 → ATM Hardware	The machine should have a self-powered GPS device within the machine, so that the machine can be tracked in case it has been uprooted and taken away. The GPS device should be capable of providing longitude and latitude coordinates. The GPS device should be integrated with the XFS layer so that its coordinates' data can be read through MVS.	We request Bank to remove this clause since this feature is not available in the machines.	Terms & Conditions applicable as per RFP. Clarification: Optional.

128	24.0.0	Appendix-C1 → ATM Hardware Location	<p>The machine should have a self-powered GPS device within the machine, so that the machine can be tracked in case it has been uprooted and taken away. The GPS device should be capable of providing longitude and latitude coordinates.</p> <p>The GPS device should be integrated with the XFS layer so that its coordinates' data can be read through MVS.</p>	As per ATM OEM 2 - This clause should be mandated	<p>Terms &amp; Conditions applicable as per RFP.</p> <p>Clarification: Optional.</p>
-----	--------	-------------------------------------	---	---	--

128	24.0.0	<p>The machine should have a self-powered GPS device within the machine, so that the machine can be tracked in case it has been uprooted and taken away. The GPS device should be capable of providing longitude and latitude coordinates. The GPS device should be integrated with the XFS layer so that its coordinates' data can be read through MVS.</p>	<p>The machine should have a self-powered GPS device within the machine, so that the machine can be tracked in case it has been uprooted and taken away. The GPS device should be capable of providing longitude and latitude coordinates. The GPS device should be integrated with the XFS layer so that its coordinates' data can be read through MVS.</p>	<p>We request Bank to remove this clause since this feature is not available in the machines.</p>	<p>Terms &amp; Conditions applicable as per RFP. Clarification: Optional.</p>
-----	--------	--	--	---	---

128	Appendix C1	24.0.0	<p>The machine should have a self-powered GPS device within the machine, so that the machine can be tracked in case it has been uprooted and taken away. The GPS device should be capable of providing longitude and latitude coordinates.</p> <p>The GPS device should be integrated with the XFS layer so that its coordinates' data can be read through MVS.</p>	This clause should be deleted	<p>Terms &amp; Conditions applicable as per RFP.</p> <p>Clarification: Optional.</p>
128	Appendix C1	24.0.0	<p>The machine should have a self-powered GPS device within the machine, so that the machine can be tracked in case it has been uprooted and taken away. The GPS device should be capable of providing longitude and latitude coordinates.</p> <p>The GPS device should be integrated with the XFS layer so that its coordinates'</p>	This clause should be deleted	<p>Terms &amp; Conditions applicable as per RFP.</p> <p>Clarification: Optional.</p>

			data can be read through MVS.		
131	AA.1.13	Appendix C1	Software to support ISO20022(XML) message emulation.	The ATM application designed to support NDC/912 cannot also support this protocol. Request the bank to remove the same.	Terms & Conditions applicable as per RFP.
131	AA.1.13	Appendix C2	Software to support ISO20022(XML) message emulation.	The ATM application designed to support NDC/912 cannot also support this protocol. Request the bank to remove the same.	Terms & Conditions applicable as per RFP.
131	AA.1.13	Appendix-C1 → ATM Hardware ATM APPL	Software to support ISO20022(XML) message emulation.	As per ATM OEM 2 - The ATM application designed to support NDC/912 cannot also support this protocol. Request the bank to amend the same.	Terms & Conditions applicable as per RFP.

131	Appendix C1	AA.1.13	Software to support ISO20022(XML) message emulation.	The ATM application designed to support NDC/912 cannot also support this protocol. Request the bank to remove the same.	Terms & Conditions applicable as per RFP.
131	Appendix C1	AA.1.13	Software to support ISO20022(XML) message emulation.	The ATM application designed to support NDC/912 cannot also support this protocol. Request the bank to remove the same.	Terms & Conditions applicable as per RFP.
132	C.1.11	Appendix-C	Support B 2 B	Request bank to clarify	Terms & Conditions applicable as per RFP.
132	C.1.3 to C.1.15 (PAGE 132 -134)	Appendix-C	Support FD/Card to Card transfer/ Card to account transfer/Visa Money Transfer/Utility Bill Payment	We request bank to clarify	Terms & Conditions applicable as per RFP.
137	D.1.1		Supports Windows 10 or the latest available Windows operating system	<u>In case Bank decides to go with Native application,</u> Request Bank to include Linux OS or modify clause as: Supports Windows 10 or the latest available Windows operating system or Linux OS in case bank decides to use Native application	Terms & Conditions applicable as per RFP.

137	D.1.1		Supports Windows 10 or the latest available Windows operating system	<u>In case Bank decides to go with Native application,</u> Request Bank to include Linux OS or modify clause as: Supports Windows 10 or the latest available Windows operating system or Linux OS in case bank decides to use Native application	Terms & Conditions applicable as per RFP.
137	D.1.3	ATM-APPL	Provide Text-to-Speech (TTS) support in English, Hindi and regional languages	As per the IBA guidelines TTS support required for English & Hindi only not for regional languages.	Terms & Conditions applicable as per RFP.
142	AD1.2.0	APPENDIX-C3 ATM SUPPORT Services	Tracking delivery of cash. Ability of MS tool to integrate with a generic tracking tool	There must be a security Concern. Would request the Bank to review it once again.	Terms & Conditions applicable as per RFP.
142	AD1.4.0	Appendix-C	Management Reports	Request bank to clarify	Terms & Conditions applicable as per RFP.
142	AD1.4.3	Appendix-C	Cost optimization	Request bank to clarify	Terms & Conditions applicable as per RFP.
142	AD2.1.0	APPENDIX-C3 ATM SUPPORT Services	ESR - Secure electronic interface between Management Centre, Bank and cash replenishment agencies	Need more clarity on the same	Terms & Conditions applicable as per RFP.

151	APPENDIX-C3 ATM SUPPORT Services AJ.5.0		Supply and replenish receipt printer rolls customized as per Bank's requirements. One side of the roll will have to be pre-printed with text provided by the Bank and printing at the ATM will be only on the blank side. Print matter may be changed as and when required	Request the bank to allow time to use up the existing stock before circulation of newly branded RP roll. This will help to save wastage of paper.	Terms & Conditions applicable as per RFP.
153	AK.5.0	CASH-REPL	There should be no cap to the number of cash runs performed per day / month	Max- 12 for regular loading and 10 for CS	Terms & Conditions applicable as per RFP.
153	APPENDIX-C3 ATM SUPPORT Services AK.5.0	AK.5.0	There should be no cap to the number of cash runs performed per day / month	Additional charges would be required in case the bank does not supply cash as per requirements	Terms & Conditions applicable as per RFP.
155	Appendix C4- Specification	Specifications of UPS and Batteries	8 Hrs backup and 8600VAh both mentioned	As in case of Lithium Batteries the Vah is different way calculated and 7200VAH is enough for 8 hrs backup against 8600VAh in SMF batteries as the DOD for SMF is 60% and Lithium is 90%.	Terms & Conditions applicable as per RFP.



155	Appendix-C4	Appendix C4	<p><b>UPS &amp; Batteries</b></p> <ul style="list-style-type: none"> <li>• The UPS &amp; Batteries are to be kept in Back room. A back room required for keeping all peripherals like UPS, Batteries, Modems, e-Surveillance panels etc.</li> <li>• The battery back-up capacity will depend on the main power supply in that area.</li> <li>• UPS should have Simple Network Management Protocol (SNMP) for polling, wherever SNMP cards are provided for UPS and necessary feed is received.</li> </ul>	<p><b>Please Clarify:</b></p> <p>At site where exist the UPS, this UPS will be part of ATM/Buyback item?</p> <p>If yes, SBI shall invoice as separate item in UPS and old batteries.</p> <p>Please clarify SBI's intentions.</p>	<p><b>Terms &amp; Conditions applicable as per RFP.</b></p>
-----	-------------	-------------	---	--	---

155	Appendix-C4	Appendix C4	<p><b>UPS &amp; Batteries</b></p> <ul style="list-style-type: none"> <li>• The UPS &amp; Batteries are to be kept in Back room. A back room required for keeping all peripherals like UPS, Batteries, Modems, e-Surveillance panels etc.</li> <li>• The battery back-up capacity will depend on the main power supply in that area.</li> <li>• UPS should have Simple Network Management Protocol (SNMP) for polling, wherever SNMP cards are provided for UPS and necessary feed is received.</li> </ul>	<p><b>Please Clarify:</b></p> <p>At site where exist the UPS, this UPS will be part of ATM/Buyback item?</p> <p>If yes, SBI shall invoice as separate item in UPS and old batteries.</p>	<p><b>Terms &amp; Conditions applicable as per RFP.</b></p>
-----	-------------	-------------	---	--	---

155	Appendix-C4	Appendix C4	<p><b>UPS &amp; Batteries</b></p> <ul style="list-style-type: none"> <li>• The UPS &amp; Batteries are to be kept in Back room. A back room required for keeping all peripherals like UPS, Batteries, Modems, e-Surveillance panels etc.</li> <li>• The battery back-up capacity will depend on the main power supply in that area.</li> <li>• UPS should have Simple Network Management Protocol (SNMP) for polling, wherever SNMP cards are provided for UPS and necessary feed is received.</li> </ul>	<p><b>Please Clarify:</b></p> <p>At site where exist the UPS, this UPS will be part of ATM/Buyback item?</p> <p>If yes, SBI shall invoice as separate item in UPS and old batteries.</p> <p>Please clarify SBI's intentions.</p>	<p><b>Terms &amp; Conditions applicable as per RFP.</b></p>
-----	-------------	-------------	---	--	---

155	Appendix-C4	Appendix C4	<p><b>UPS &amp; Batteries</b></p> <ul style="list-style-type: none"> <li>• The UPS &amp; Batteries are to be kept in Back room. A back room required for keeping all peripherals like UPS, Batteries, Modems, e-Surveillance panels etc.</li> <li>• The battery back-up capacity will depend on the main power supply in that area.</li> <li>• UPS should have Simple Network Management Protocol (SNMP) for polling, wherever SNMP cards are provided for UPS and necessary feed is received.</li> </ul>	<p><b>Please Clarify:</b></p> <p>At site where exist the UPS, this UPS will be part of ATM/Buyback item?</p> <p>If yes, SBI shall invoice as separate item in UPS and old batteries.</p> <p>Please clarify SBI's intentions.</p>	<p><b>Terms &amp; Conditions applicable as per RFP.</b></p>
-----	-------------	-------------	---	--	---

155	Appendix-C4	<p><b>UPS &amp; Batteries</b></p> <ul style="list-style-type: none"> <li>• The UPS &amp; Batteries are to be kept in Back room. A back room required for keeping all peripherals like UPS, Batteries, Modems, e-Surveillance panels etc.</li> <li>• The battery back-up capacity will depend on the main power supply in that area.</li> <li>• UPS should have Simple Network Management Protocol (SNMP) for polling, wherever SNMP cards are provided for UPS and necessary feed is received.</li> </ul>	<p><b>Please Clarify:</b></p> <p>At site where exist the UPS, this UPS will be part of ATM/Buyback item?</p>	<p><b>Terms &amp; Conditions applicable as per RFP.</b></p>
-----	-------------	---	--	---

155

**Appendix-C4 –  
Specifications of UPS &  
BATTERIES**

**UPS & Batteries**

- The UPS & Batteries are to be kept in Back room. A back room required for keeping all peripherals like UPS, Batteries, Modems, e-Surveillance panels etc.
- The battery back-up capacity will depend on the main power supply in that area.
- UPS should have Simple Network Management Protocol (SNMP) for polling, wherever SNMP cards are provided for UPS and necessary feed is received.

**As per ATM OEM 1 - Please Clarify:**

**Will existing UPS at site will be part of ATM/Buyback item?  
If yes, Bank shall invoice it as a separate line item under UPS and old batteries.**

**Please suggest, Bank's viewpoint on the same.**

**Terms & Conditions applicable as per RFP.**

157	Appendix E	IV	<p>All existing Compliances of Guidelines /Advisory/ Orders/ Instructions/SOP issued by Bank, State / District / Local Administration / GoI / IBA / RBI / MHA / NPCI or any other statutory authority etc. must be followed ab initio by successful bidders for each machine / site for all works / services under this RFP. <b>Any future guidelines/advisory by any statutory authority shall be complied without any cost to the Bank</b></p>	<p>The bidder will abide and meet all the regulatory and Compliance guidelines as on the date of bid submission. Bidder cannot evisege the future guidelines/advisory by statutoy authority and hence cannot estimate the impact of the same currently. So request bank to limit the compliance to only current and any future complainces to be discussed and agreed mutually based on its impact.</p> <p>For example when the MoF agreement was signed there was no cassette swap or MHA guidelines . These guidelines were introduced later and had huge impact on the overall operation and price.</p>	<p><b>CORRIGENDUM:</b> All existing Compliances of Guidelines /Advisory/ Orders/ Instructions/SOP issued by Bank, State / District / Local Administration / GoI / IBA / RBI / MHA / NPCI or any other statutory authority etc. must be followed ab initio by successful bidders for each machine / site for all works / services under this RFP. Any <b>new</b> future guidelines /advisory by any statutory / <b>regulatory</b> authority shall be complied <del>without any cost to the Bank</del> <b>with mutually agreed terms &amp; conditions and within the timeline advised by the authority.</b></p>
-----	------------	----	--	--	---

157	Appendix E, point IV	Appendix-E SCOPE OF WORK	<p>All existing Compliances of Guidelines /Advisory/ Orders/ Instructions/SOP issued by Bank, State / District / Local Administration / Gol / IBA / RBI / MHA / NPCI or any other statutory authority etc. must be followed ab initio by successful bidders for each machine / site for all works / services under this RFP. <b>Any future guidelines/advisory by any statutory authority shall be complied without any cost to the Bank. Few illustrative but not exhaustive guidelines are as under: -</b></p>	<p>We request Bank to consider all future upgrades at mutually agreed cost with successful bidder.</p>	<p><b>CORRIGENDUM:</b>  All existing Compliances of Guidelines /Advisory/ Orders/ Instructions/SOP issued by Bank, State / District / Local Administration / Gol / IBA / RBI / MHA / NPCI or any other statutory authority etc. must be followed ab initio by successful bidders for each machine / site for all works / services under this RFP. Any <b>new</b> future guidelines /advisory by any statutory / <b>regulatory</b> authority shall be complied <del>without any cost to the Bank</del> <b>with mutually agreed terms &amp; conditions and within the timeline advised by the authority.</b></p>
-----	----------------------	--------------------------	--	--	--



157	IV	Appendix E	<p>All existing Compliances of Guidelines /Advisory/ Orders/ Instructions/SOP issued by Bank, State / District / Local Administration / Gol / IBA / RBI / MHA / NPCI or any other statutory authority etc. must be followed ab initio by successful bidders for each machine / site for all works / services under this RFP. <b>Any future guidelines/advisory by any statutory authority shall be complied without any cost to the Bank</b></p>	<p>The bidder will abide and meet all the regulatory and Compliance guidelines as on the date of bid submission. Bidder cannot envisage the future guidelines/advisory by statutory authority and hence cannot estimate the impact of the same currently. So request bank to limit the compliance to only current and any future compliances to be discussed and agreed mutually based on its impact.</p>	<p><b>CORRIGENDUM:</b>  All existing Compliances of Guidelines /Advisory/ Orders/ Instructions/SOP issued by Bank, State / District / Local Administration / Gol / IBA / RBI / MHA / NPCI or any other statutory authority etc. must be followed ab initio by successful bidders for each machine / site for all works / services under this RFP. Any <b>new</b> future guidelines /advisory by any statutory / <b>regulatory</b> authority shall be complied <del>without any cost to the Bank</del> <b>with mutually agreed terms &amp; conditions and within the timeline advised by the authority.</b></p>
-----	----	------------	--	---	--

157	IV	Appendix E	<p>All existing Compliances of Guidelines /Advisory/ Orders/ Instructions/SOP issued by Bank, State / District / Local Administration / Gol / IBA / RBI / MHA / NPCI or any other statutory authority etc. must be followed ab initio by successful bidders for each machine / site for all works / services under this RFP. <b>Any future guidelines/advisory by any statutory authority shall be complied without any cost to the Bank</b></p>	<p>The bidder will abide and meet all the regulatory and Compliance guidelines as on the date of bid submission. Bidder cannot envisage the future guidelines/advisory by statutory authority and hence cannot estimate the impact of the same currently. So request bank to limit the compliance to only current and any future compliances to be discussed and agreed mutually based on its impact.</p>	<p><b>CORRIGENDUM:</b> All existing Compliances of Guidelines /Advisory/ Orders/ Instructions/SOP issued by Bank, State / District / Local Administration / Gol / IBA / RBI / MHA / NPCI or any other statutory authority etc. must be followed ab initio by successful bidders for each machine / site for all works / services under this RFP. Any <b>new</b> future guidelines /advisory by any statutory / <b>regulatory</b> authority shall be complied <del>without any cost to the Bank</del> <b>with mutually agreed terms &amp; conditions and within the timeline advised by the authority.</b></p>
-----	----	------------	--	---	---

157	IV	Appendix-E	<p>All existing Compliances of Guidelines /Advisory/ Orders/ Instructions/SOP issued by Bank, State / District / Local Administration / GoI / IBA / RBI / MHA / NPCI or any other statutory authority etc. must be followed ab initio by successful bidders for each machine / site for all works / services under this RFP. <b>Any future guidelines/advisory by any statutory authority shall be complied without any cost to the Bank.</b></p>	<p>We request bank Bidder cannot predict any future Regulatory compliance which may be issued later in next 7 years. Requesting bank to change this clause as vendor to upgrade physical devices/software/drivers till the submission of bid and any upgrade required after bid submission will be done in mutually agreed cost.</p>	<p><b>CORRIGENDUM:</b>  All existing Compliances of Guidelines /Advisory/ Orders/ Instructions/SOP issued by Bank, State / District / Local Administration / GoI / IBA / RBI / MHA / NPCI or any other statutory authority etc. must be followed ab initio by successful bidders for each machine / site for all works / services under this RFP. Any <b>new</b> future guidelines /advisory by any statutory / <b>regulatory</b> authority shall be complied <del>without any cost to the Bank</del> <b>with mutually agreed terms &amp; conditions and within the timeline advised by the authority.</b></p>
-----	----	------------	---	--	--

157	IV	Appendix-E SCOPE OF WORK	<p>All existing Compliances of Guidelines /Advisory/ Orders/ Instructions/SOP issued by Bank, State / District / Local Administration / Gol / IBA / RBI / MHA / NPCI or any other statutory authority etc. must be followed ab initio by successful bidders for each machine / site for all works / services under this RFP. <u>Any future guidelines/advisory by any statutory authority shall be complied without any cost to the Bank.</u> Few illustrative but not exhaustive guidelines are as under:</p>	<p>The bidder will abide and meet all the regulatory and Compliance guidelines as on the date of bid submission. Bidder cannot envisage the future guidelines/advisory by statutory authority and hence cannot estimate the impact of the same currently. So request bank to limit the compliance to only current and any future compliances to be discussed and agreed mutually based on its impact.</p> <p>Bidder would like to clarify that any additional costs involved in complying with this requirement, the cost will be borne by the Bank.</p>	<p><b>CORRIGENDUM:</b> All existing Compliances of Guidelines /Advisory/ Orders/ Instructions/SOP issued by Bank, State / District / Local Administration / Gol / IBA / RBI / MHA / NPCI or any other statutory authority etc. must be followed ab initio by successful bidders for each machine / site for all works / services under this RFP. Any <b>new</b> future guidelines /advisory by any statutory / <b>regulatory</b> authority shall be complied <del>without any cost to the Bank</del> <b>with mutually agreed terms &amp; conditions and within the timeline advised by the authority.</b></p>
-----	----	-----------------------------	--	--	---

157	IV	Scope of Work	<p>All existing Compliances of Guidelines /Advisory/ Orders/ Instructions/SOP issued by Bank, State / District / Local Administration / Gol / IBA / RBI / MHA / NPCI or any other statutory authority etc. must be followed ab initio by successful bidders for each machine / site for all works / services under this RFP. Any future guidelines/advisory by any statutory authority shall be complied without any cost to the Bank.</p>	<p>While compliance with all existing guidelines/ advisory is acceptable, any future guidelines/ advisory that are completely uncertain and cannot be accepted without any cost to the Bank. We request the Bank to keep the costs related to any future guidelines/ advisory based on mutual discussions between the Bank and Vendor.</p>	<p><b>CORRIGENDUM:</b> All existing Compliances of Guidelines /Advisory/ Orders/ Instructions/SOP issued by Bank, State / District / Local Administration / Gol / IBA / RBI / MHA / NPCI or any other statutory authority etc. must be followed ab initio by successful bidders for each machine / site for all works / services under this RFP. Any <b>new</b> future guidelines /advisory by any statutory / <b>regulatory</b> authority shall be complied <del>without any cost to the Bank</del> <b>with mutually agreed terms &amp; conditions and within the timeline advised by the authority.</b></p>
-----	----	---------------	--	--	---

157	IV.	Appendix E - Scope of Work - Note	<p>All existing Compliances of Guidelines /Advisory/ Orders/ Instructions/SOP issued by Bank, State / District / Local Administration / Gol / IBA / RBI / MHA / NPCI or any other statutory authority etc. must be followed ab initio by successful bidders for each machine / site for all works / services under this RFP. <b>Any future guidelines/advisory by any statutory authority shall be complied without any cost to the Bank</b></p>	<p>The bidder will abide and meet all the regulatory and Compliance guidelines as on the date of bid submission. We cannot envisage the future guidelines/advisory by statutory authority and hence cannot estimate the impact of the same currently. So request bank to limit the compliance to only current and any future compliances to be discussed and agreed mutually based on its impact.</p>	<p><b>CORRIGENDUM:</b>  All existing Compliances of Guidelines /Advisory/ Orders/ Instructions/SOP issued by Bank, State / District / Local Administration / Gol / IBA / RBI / MHA / NPCI or any other statutory authority etc. must be followed ab initio by successful bidders for each machine / site for all works / services under this RFP. Any <b>new</b> future guidelines /advisory by any statutory / <b>regulatory</b> authority shall be complied <del>without any cost to the Bank</del> <b>with mutually agreed terms &amp; conditions and within the timeline advised by the authority.</b></p>
-----	-----	-----------------------------------	--	---	--

158	IV. (I)	Appendix E - Scope of Work - Note	Manage/ perform the RD services (Device Registration, Key-Exchange/ Rotation Activity, etc.) as per the guidelines or directives received from UIDAI titled "AADHAAR REGISTERED DEVICES TECHNICAL SPECIFICATION - VERSION 2.0 (REVISION 1)" dated February 2017 or any amendments/ updates thereto, instructions/ guidelines of UIDAI/ RBI/ IBA regarding biometric authentication, in relation to the Fingerprint Biometric devices supplied with the ATMs/ CDs for the length of the contract, at no additional cost to the Bank etc.) for the RD services (incl. Key – Exchange / Rotation) is to be provided and maintained by the	Need more clarity on the same	Terms & Conditions applicable as per RFP
-----	---------	-----------------------------------	--	-------------------------------	--

			<p>Endpoint Provider/ OEM, at no additional cost to the Bank. The infrastructure (HW, SW, HSM, etc.) for the RD services (incl. Key- Exchange/ Rotation) is to be provided and maintained by the OEM, at no additional cost to the Bank</p>		
--	--	--	---	--	--



159	1	INSTALLATION OF BRAND-NEW ATMS:	c) The ATMs should be maintained by the Bidder / Vendor for the contract period of 7 years (2557 days) which can be extended upto 10 years (i.e., upto another three years in one or more tranches after base 7 years period), at the sole discretion of the Bank. The AMC shall be carried out by OEM or its authorized dealers for a period not less than 7 years and extensions thereof.	Request for clarity on AMC term mentioned here	Terms & Conditions applicable as per RFP
159	1 b	Appendix E	Bidder should provide all new ATMs (not refurbished) with biometric functionality of a particular OEM and particular model with OEM Native application	Bank to clarify whether Bank is looking at running these machines on MVS or Native application	Terms & Conditions applicable as per RFP

159	1. b)	Appendix E - Scope of Work INSTALLATION OF BRAND-NEW ATMS	Bidder should provide all new ATMs (not refurbished) with biometric functionality of a particular OEM and particular model with OEM Native application	As per ATM OEM 2 - Bank to clarify whether Bank is looking at running these machines on MVS or Native application	Terms & Conditions applicable as per RFP
159	Appendix E	1 b	Bidder should provide all new ATMs (not refurbished) with biometric functionality of a particular OEM and particular model with OEM Native application	Bank to clarify whether Bank is looking at running these machines on MVS or Native application	Terms & Conditions applicable as per RFP
159	Appendix E	1 b	Bidder should provide all new ATMs (not refurbished) with biometric functionality of a particular OEM and particular model with OEM Native application	Bank to clarify whether Bank is looking at running these machines on MVS or Native application. As in some places Bank has asked to supply MVS software and at other places Native software. If the Native software is to be provided then it should be done at an incremental price whenever the bank intend to deploy Native software	Terms & Conditions applicable as per RFP

159	INSTALLATION OF BRAND-NEW ATMS:		d) Cash Replenishment Services / Cash Evacuation Services with lockable cassettes swap method (mandatory ab-initio) for all machines, usage of OTC (One time Combination) in vault locks of machines ab-initio. Vendors to arrange and maintain (including replacement of faulty ones) for all set(s) of lockable cassettes + reject / retract / counterfeit bins, as and when required, during the entire contract period and extensions thereof.	Need clarity on lockable. It has to be sealable where one time seal can be tagged	Terms & Conditions applicable as per RFP
159	IV. (n)	Appendix E - Scope of Work- Note	RBI Cash out Penalty: RBI / 2021-22 / 84 – DCM (RMMT) No. S153 / 11.01.01 / 2021-22 dated 10.08.2021.	Kindly suggest the penalty amount decided by the Bank during RBI cash out penalty	Terms & Conditions applicable as per RFP

160	1 ( g )	INSTALLATION OF BRAND-NEW ATMS	<p>If during the Contract period and extensions thereof, an endpoint is frequently becoming out of order for technical reasons for more than three times in a month and for two consecutive months, the Bank may ask the bidder to replace the endpoint with another new endpoint of same model &amp; make with exactly same technical specifications as tested in the SBI ATM-Lab before the commencement of rollout under this RFP, at no extra cost to the Bank. <b>The selected bidder should update / supply / install necessary changes in endpoint, if any, due to regulatory compliance, the same should be available at no additional cost to the Bank irrespective whether it being</b></p>	<p>Any future regulatory compliances, and/or modifications whether major or minor (required to be followed by both Bank and the Bidder and/or any party), shall be as per mutually agreed cost</p>	<p>Terms &amp; Conditions applicable as per RFP</p>
-----	---------	--------------------------------	---	--	---

		minor or major modification.			
--	--	------------------------------	--	--	--

160	1 h ii	Appendix E	Bidder to provide all Licences, updated Softwares and OEM support required for the development, testing, and implementation of any feature using the Biometric Devices, without any cost to the Bank.	Bidder with provide the hardware and the drivers for the biometric device. It will be the responsibility of the application (Solution provider) to do the development testing and implementation of the functionality. Request Bank to please acknowledge the same.	Terms & Conditions applicable as per RFP
160	1 h ii	Appendix E	Bidder to provide all Licences, updated Softwares and OEM support required for the development, testing, and implementation of any feature using the Biometric Devices, without any cost to the Bank.	Bidder with provide the hardware and the drivers for the biometric device. It will be the responsibility of the application (Solution provider) to do the development testing and implementation of the functionality. Request Bank to please acknowledge the same.	Terms & Conditions applicable as per RFP

160	1. h).i	<p>Appendix E - Scope of Work  <b>INSTALLATION OF BRAND-NEW ATMS BIOMETRIC READERS / DEVICES</b></p>	<p>Endpoint Provider providing the Fingerprint Biometric device will also need to manage / perform the RD services (Device Registration, Key-Exchange / Rotation Activity, etc.) as per the guidelines or directives received from UIDAI titled "AADHAAR REGISTERED DEVICES TECHNICAL SPECIFICATION - VERSION 2.0 (REVISION 1)" dated February 2017 or any amendments/ updates thereto, and any other instructions/ guidelines of UIDAI/ RBI/ IBA regarding biometric authentication, in relation to the Fingerprint Biometric devices supplied with the Endpoints for the length of the contract, at no additional cost to the Bank etc.) for</p>	<p>As per ATM OEM 2 - RD service hosting done by the Fingerprint device OEM, as per the UIDAI guideline. Connectivity to RD server and necessary firewall will be the Bank's responsibility.</p>	<p>Terms &amp; Conditions applicable as per RFP</p>
-----	---------	--	--	--	---

			<p>the RD services (incl. Key - Exchange/ Rotation) is to be provided and maintained by the Endpoint Provider/ OEM, an no additional cost to the Bank. The infrastructure (HW, SW, HSM, etc.) for the RD services (incl. Key-Exchange/ Rotation) is to be provided and maintained by the Bidder, at no additional cost to the Bank</p>		
--	--	--	--	--	--



160	1. h).ii	Appendix E - Scope of Work INSTALLATION OF BRAND-NEW ATMS BIOMETRIC READERS / DEVICES	Bidder to provide all Licences, updated Softwares and OEM support required for the development, testing, and implementation of any feature using the Biometric Devices, without any cost to the Bank.	As per ATM OEM 2 - We will provide the hardware and the drivers for the biometric. However, it will be the responsibility of the application (Solution provider) to do the development testing and implementation of the functionality. Request Bank to please acknowledge the same	Terms & Conditions applicable as per RFP
-----	----------	--	---	--	--

160	1h i	Appendix E	<p>Endpoint Provider providing the Fingerprint Biometric device will also need to manage / perform the RD services (Device Registration, Key-Exchange / Rotation Activity, etc.) as per the guidelines or directives received from UIDAI titled "AADHAAR REGISTERED DEVICES TECHNICAL SPECIFICATION - VERSION 2.0 (REVISION 1)" dated February 2017 or any amendments/ updates thereto, and any other instructions/ guidelines of UIDAI/ RBI/ IBA regarding biometric authentication, in relation to the Fingerprint Biometric devices supplied with the Endpoints for the length of the contract, at no additional cost to the Bank etc.) for</p>	<p>RD service hosting done by the Fingerprint device OEM as per the UIDAI guideline. Connectivity to RD server and necessary firewall will be the Banks responsibility. This will work for all the ATM OEMs so that there is no burden to ATM OEMs and Bank to make connection to RD server per OEM</p>	<p>Terms &amp; Conditions applicable as per RFP</p>
-----	------	------------	--	---	---

			<p>the RD services (incl. Key - Exchange/ Rotation) is to be provided and maintained by the Endpoint Provider/ OEM, an no additional cost to the Bank. The infrastructure (HW, SW, HSM, etc.) for the RD services (incl. Key-Exchange/ Rotation) is to be provided and maintained by the Bidder, at no additional cost to the Bank.</p>		
--	--	--	---	--	--

160	1h i	Appendix E	<p>Endpoint Provider providing the Fingerprint Biometric device will also need to manage / perform the RD services (Device Registration, Key-Exchange / Rotation Activity, etc.) as per the guidelines or directives received from UIDAI titled "AADHAAR REGISTERED DEVICES TECHNICAL SPECIFICATION - VERSION 2.0 (REVISION 1)" dated February 2017 or any amendments/ updates thereto, and any other instructions/ guidelines of UIDAI/ RBI/ IBA regarding biometric authentication, in relation to the Fingerprint Biometric devices supplied with the Endpoints for the length of the contract, at no additional cost to the Bank etc.) for</p>	<p>RD service hosting done by the Fingerprint device OEM as per the UIDAI guideline. Connectivity to RD server and necessary firewall will be the Banks responsibility. This will work for all the ATM OEMs so that there is no burden to ATM OEMs and Bank to make connection to RD server per OEM</p>	<p>Terms &amp; Conditions applicable as per RFP</p>
-----	------	------------	--	---	---

			<p>the RD services (incl. Key - Exchange/ Rotation) is to be provided and maintained by the Endpoint Provider/ OEM, an no additional cost to the Bank. The infrastructure (HW, SW, HSM, etc.) for the RD services (incl. Key-Exchange/ Rotation) is to be provided and maintained by the Bidder, at no additional cost to the Bank.</p>		
--	--	--	---	--	--

160	Appendix E	1 h ii	Bidder to provide all Licences, updated Softwares and OEM support required for the development, testing, and implementation of any feature using the Biometric Devices, without any cost to the Bank.	Bidder with provide the hardware and the drivers for the biometric device. It will be the responsibility of the application (Solution provider) to do the development testing and implementation of the functionality. Request Bank to please acknowledge the same.	Terms & Conditions applicable as per RFP
160	Appendix E	1 h ii	Bidder to provide all Licences, updated Softwares and OEM support required for the development, testing, and implementation of any feature using the Biometric Devices, without any cost to the Bank.	Bidder with provide the hardware and the drivers for the biometric device. It will be the responsibility of the application (Solution provider) to do the development testing and implementation of the functionality. Request Bank to please acknowledge the same.	Terms & Conditions applicable as per RFP

160	Appendix E	1h i	<p>Endpoint Provider providing the Fingerprint Biometric device will also need to manage / perform the RD services (Device Registration, Key-Exchange / Rotation Activity, etc.) as per the guidelines or directives received from UIDAI titled "AADHAAR REGISTERED DEVICES TECHNICAL SPECIFICATION - VERSION 2.0 (REVISION 1)" dated February 2017 or any amendments/ updates thereto, and any other instructions/ guidelines of UIDAI/ RBI/ IBA regarding biometric authentication, in relation to the Fingerprint Biometric devices supplied with the Endpoints for the length of the contract, at no additional cost to the Bank etc.) for</p>	<p>RD service hosting done by the Fingerprint device OEM as per the UIDAI guideline. Connectivity to RD server and necessary firewall will be the Banks responsibility. This will work for all the ATM OEMs so that there is no burden to ATM OEMs and Bank to make connection to RD server per OEM</p>	<p>Terms &amp; Conditions applicable as per RFP</p>
-----	------------	------	--	---	---

			<p>the RD services (incl. Key - Exchange/ Rotation) is to be provided and maintained by the Endpoint Provider/ OEM, an no additional cost to the Bank. The infrastructure (HW, SW, HSM, etc.) for the RD services (incl. Key-Exchange/ Rotation) is to be provided and maintained by the Bidder, at no additional cost to the Bank.</p>		
--	--	--	---	--	--



160	Appendix E	1h i	<p>Endpoint Provider providing the Fingerprint Biometric device will also need to manage / perform the RD services (Device Registration, Key-Exchange / Rotation Activity, etc.) as per the guidelines or directives received from UIDAI titled "AADHAAR REGISTERED DEVICES TECHNICAL SPECIFICATION - VERSION 2.0 (REVISION 1)" dated February 2017 or any amendments/ updates thereto, and any other instructions/ guidelines of UIDAI/ RBI/ IBA regarding biometric authentication, in relation to the Fingerprint Biometric devices supplied with the Endpoints for the length of the contract, at no additional cost to the Bank etc.) for</p>	<p>RD service hosting done by the Fingerprint device OEM as per the UIDAI guideline. Connectivity to RD server and necessary firewall will be the Banks responsibility. This will work for all the ATM OEMs so that there is no burden to ATM OEMs and Bank to make connection to RD server per OEM</p>	<p>Terms &amp; Conditions applicable as per RFP</p>
-----	------------	------	--	---	---

			<p>the RD services (incl. Key - Exchange/ Rotation) is to be provided and maintained by the Endpoint Provider/ OEM, an no additional cost to the Bank. The infrastructure (HW, SW, HSM, etc.) for the RD services (incl. Key-Exchange/ Rotation) is to be provided and maintained by the Bidder, at no additional cost to the Bank.</p>		
--	--	--	---	--	--

160	f		<p>Bidders should offer model of ATMs with the Operating System Windows 11 and CEN XFS 3.1 or higher compliant layer, that is state of the art machines capable of running the Bank's Multi-Vendor Software and Endpoint Protection Solution and which will have to be supported for a minimum period of 7 years after installation / operationalization, extendable up to a period of 10 years at the discretion of the Bank. The Bank wants advanced, multifunctional, energy-efficient system. In case, endpoint with Windows 11 is not ready, bidder can submit the bid for model compatible with Windows 10 IoT Enterprise 2019</p>	<p><u>In case Bank decides to go with Native application,</u> Request Bank to include Linux OS Bidders should offer model of ATMs with the Operating System Windows 11 and CEN XFS 3.1 or higher compliant layer, that is state of the art machines capable of running the Bank's Multi-Vendor Software and Endpoint Protection Solution and which will have to be supported for a minimum period of 7 years after installation / operationalization, extendable up to a period of 10 years at the discretion of the Bank. The Bank wants advanced, multifunctional, energy-efficient system. In case, endpoint with Windows 11 is not ready, bidder can submit the bid for model compatible with Windows 10 IoT Enterprise 2019 or above (with a license of Windows11) or Linux subject to condition that endpoint supplied / installed should be upgraded with supported OS</p>	<p>Terms &amp; Conditions applicable as per RFP</p>
-----	---	--	--	---	---

			<p>or above (with a license of Windows11) subject to condition that endpoint supplied / installed should be upgraded with Windows 11 before end of life for Windows-10 by Microsoft without any cost to the Bank.</p>	<p>before end of life without any cost to the Bank.</p>	
--	--	--	---	---	--

160	f		<p>Bidders should offer model of ATMs with the Operating System Windows 11 and CEN XFS 3.1 or higher compliant layer, that is state of the art machines capable of running the Bank's Multi-Vendor Software and Endpoint Protection Solution and which will have to be supported for a minimum period of 7 years after installation / operationalization, extendable up to a period of 10 years at the discretion of the Bank. The Bank wants advanced, multifunctional, energy-efficient system. In case, endpoint with Windows 11 is not ready, bidder can submit the bid for model compatible with Windows 10 IoT Enterprise 2019</p>	<p><u>In case Bank decides to go with Native application,</u> Request Bank to include Linux OS Bidders should offer model of ATMs with the Operating System Windows 11 and CEN XFS 3.1 or higher compliant layer, that is state of the art machines capable of running the Bank's Multi-Vendor Software and Endpoint Protection Solution and which will have to be supported for a minimum period of 7 years after installation / operationalization, extendable up to a period of 10 years at the discretion of the Bank. The Bank wants advanced, multifunctional, energy-efficient system. In case, endpoint with Windows 11 is not ready, bidder can submit the bid for model compatible with Windows 10 IoT Enterprise 2019 or above (with a license of Windows11) or Linux subject to condition that endpoint supplied / installed should be upgraded with supported OS</p>	<p>Terms &amp; Conditions applicable as per RFP</p>
-----	---	--	--	---	---

			<p>or above (with a license of Windows11) subject to condition that endpoint supplied / installed should be upgraded with Windows 11 before end of life for Windows-10 by Microsoft without any cost to the Bank.</p>	<p>before end of life without any cost to the Bank.</p>	
--	--	--	---	---	--

161	1.h.	Appendix - E Scope of Work BIOMETRIC READERS / DEVICES:	A penalty of Rs.1,000 per day per non-complied machine shall be imposed for delay beyond the specified timeframe or for non-compliance of the Letter of Intent / Confirmation Letter	Maximum penalty in a month shall be capped.	Terms & Conditions applicable as per RFP
-----	------	--	--	---	--

161	Appendix E	i	<p>All endpoints should have anti-skimming devices / solutions, anti-shimming devices / solutions, anti-deep-insert-skimmers, any other device or solution etc. to prevent unauthorized reading and copying of card data (of card's magstripe or chip) from card-reader and contactless card reader, biometric data from biometric reader. Bidder to ensure that no cloning of card data to occur through machine. Bidder to upgrade the physical devices / components and applicable softwares / drivers whenever released by OEMs, without any cost to Bank. Any loss of the Bank in this regard shall be completely borne by the bidder. The Bank shall issue Letter of Intent / Confirmation Letter</p>	<p>We have inbuilt latest Anti-skimming solution available as per the all known type of skimming attacks. We will be making any changes if required at the later date as need comes. We cannot envisage what could happen and what changes needed which may take sometime for us to make changes. We request bank to look into this and provide a reasonable time to make changes if needed. Skimming is limited to Mag strip data and EMV, Contactless and Biometrics are not part of this skimming hence these should be kept out from the skimming scope. We wont be having any knowledge of evolving any such attacks if any.</p>	<p>Terms &amp; Conditions applicable as per RFP</p>
-----	------------	---	---	---	---



		<p>for installation of any such upgraded hardware / physical devices / components and applicable software or any standalone software after duly testing at its ATM-Lab. The rollout / installation of the upgrade (hardware and / or software, as applicable) should be done within the timeframe specified in the Letter of Intent / Confirmation Letter. A penalty of Rs.1,000 per day per non-complied machine shall be imposed for delay beyond the specified timeframe or for non-compliance of the Letter of Intent / Confirmation Letter.</p>		
--	--	--	--	--

161	Appendix E	i	<p>All endpoints should have anti-skimming devices / solutions, anti-shimming devices / solutions, anti-deep-insert-skimmers, any other device or solution etc. to prevent unauthorized reading and copying of card data (of card's magstripe or chip) from card-reader and contactless card reader, biometric data from biometric reader. Bidder to ensure that no cloning of card data to occur through machine. Bidder to upgrade the physical devices / components and applicable softwares / drivers whenever released by OEMs, without any cost to Bank. Any loss of the Bank in this regard shall be completely borne by the bidder. The Bank shall issue Letter of Intent / Confirmation Letter</p>	<p>if yes then "We have inbuilt latest Anti-skimming solution available as per the all known type of skimming attacks. We will be making any changes if required at the later date as need comes. We cannot envisage what could happen and what changes needed which may take sometime for us to make changes. We request bank to look into this and provide a reasonable time to make changes if needed. Skimming is limited to Mag strip data and EMV, Contactless and Biometrics are not part of this skimming hence these should be kept out from the skimming scope. We wont be having any knowledge of evolving any such attacks if any."</p>	<p>Terms &amp; Conditions applicable as per RFP</p>
-----	------------	---	---	---	---

		<p>for installation of any such upgraded hardware / physical devices / components and applicable software or any standalone software after duly testing at its ATM-Lab. The rollout / installation of the upgrade (hardware and / or software, as applicable) should be done within the timeframe specified in the Letter of Intent / Confirmation Letter. A penalty of Rs.1,000 per day per non-complied machine shall be imposed for delay beyond the specified timeframe or for non-compliance of the Letter of Intent / Confirmation Letter.</p>		
--	--	--	--	--

161	Appendix E	j	<p>All endpoints should be able to give the status of cash dispensed or not dispensed with 100% surety and the same should be recorded in the Electronic Journal (e) / machine logs / System log / switch. Internal Cash slot camera should be present to capture the movement of cash. Video / Image analytics or algorithms can be developed to ascertain the dispensation of cash. Failure to determine the cash dispensation status, the disputed amount / chargeback claim with any penalty imposed on Bank for that disputed transaction, if any, involved in such un-sure transactions will be made good by the vendor. The Bank shall support the bidder, at its own</p>	<p>All different test cases to be tested as part of UAT. In case any issue with regard to MVS application handling to be corrected along with OEM testing. Request bank to look into the same. Also in case of any new fraud that will be discussed and next course of action to handle the same.</p>	<p>Terms &amp; Conditions applicable as per RFP</p>
-----	------------	---	--	---	---

		<p>discretion, for any development required in Bank's MVS Solution or Bank's Switch. In case of any incorrect dispensation due to faulty functioning of the machine, the vendor should make good the loss within 30 days from the date of reporting of incidents and take corrective measures immediately. The Bank should not suffer loss due to any defect of the machine. The Bank's decision with regard to faulty functioning of the machine will be final and binding on the bidder. In case the defect resolution requires development / R&amp;D (Research and Development) from OEM of the endpoint, the bidder should ensure that the OEM does the required development within</p>		
--	--	---	--	--

		<p>the stipulated time agreed by the Bank. A penalty of Rs. 1,000 per day per non-complied machine shall be applicable for delay after the agreed stipulated timeframe.</p>		
--	--	---	--	--

161	Appendix E	j	<p>All endpoints should be able to give the status of cash dispensed or not dispensed with 100% surety and the same should be recorded in the Electronic Journal (eJ) / machine logs / System log / switch. Internal Cash slot camera should be present to capture the movement of cash. Video / Image analytics or algorithms can be developed to ascertain the dispensation of cash. Failure to determine the cash dispensation status, the disputed amount / chargeback claim with any penalty imposed on Bank for that disputed transaction, if any, involved in such un-sure transactions will be made good by the vendor. The Bank shall support the bidder, at its own</p>	<p>All different test cases to be tested as part of UAT. In case any issue with regard to MVS application handling to be corrected along with OEM testing. Request bank to look into the same. Also in case of any new fraud that will be discussed and next course of action to handle the same.</p>	<p>Terms &amp; Conditions applicable as per RFP</p>
-----	------------	---	---	---	---

		<p>discretion, for any development required in Bank's MVS Solution or Bank's Switch. In case of any incorrect dispensation due to faulty functioning of the machine, the vendor should make good the loss within 30 days from the date of reporting of incidents and take corrective measures immediately. The Bank should not suffer loss due to any defect of the machine. The Bank's decision with regard to faulty functioning of the machine will be final and binding on the bidder. In case the defect resolution requires development / R&amp;D (Research and Development) from OEM of the endpoint, the bidder should ensure that the OEM does the required development within</p>		
--	--	---	--	--



		<p>the stipulated time agreed by the Bank. A penalty of Rs. 1,000 per day per non-complied machine shall be applicable for delay after the agreed stipulated timeframe.</p>		
--	--	---	--	--

161	h)	BIOMETRIC READERS / DEVICES:	All endpoints should be able to give the status of cash dispensed or not dispensed with 100% surety and the same should be recorded in the Electronic Journal (eJ) / machine logs / System log / switch.	H/W error will print indicative codes to be processed by reconciliation	Terms & Conditions applicable as per RFP
-----	----	------------------------------	--	---	--

161	h)	BIOMETRIC READERS / DEVICES:	<p>j) All endpoints should be able to give the status of cash dispensed or not dispensed with 100% surety and the same should be recorded in the Electronic Journal (e) / machine logs / System log / switch. Internal Cash slot camera should be present to capture the movement of cash. Video / Image analytics or algorithms can be developed to ascertain the dispensation of cash. Failure to determine the cash dispensation status, the disputed amount / chargeback claim with any penalty imposed on Bank for that disputed transaction, if any, involved in such un-sure transactions will be made good by the vendor. The Bank shall support the bidder, at its own</p>	The Bidder request the Bank to reduce this penalty to Rs 100	Terms & Conditions applicable as per RFP
-----	----	------------------------------	---	--	--

		<p>discretion, for any development required in Bank's MVS Solution or Bank's Switch. In case of any incorrect dispensation due to faulty functioning of the machine, the vendor should make good the loss within 30 days from the date of reporting of incidents and take corrective measures immediately. The Bank should not suffer loss due to any defect of the machine. The Bank's decision with regard to faulty functioning of the machine will be final and binding on the bidder. In case the defect resolution requires development / R&amp;D (Research and Development) from OEM of the endpoint, the bidder should ensure that the OEM does the required development within</p>		
--	--	---	--	--

		<p>the stipulated time agreed by the Bank. A penalty of Rs. 1,000 per day per non-complied machine shall be applicable for delay after the agreed stipulated timeframe.</p>		
--	--	---	--	--

161	i	Appendix E	<p>All endpoints should have anti-skimming devices / solutions, anti-shimming devices / solutions, anti-deep-insert-skimmers, any other device or solution etc. to prevent unauthorized reading and copying of card data (of card's magstripe or chip) from card-reader and contactless card reader, biometric data from biometric reader. Bidder to ensure that no cloning of card data to occur through machine. Bidder to upgrade the physical devices / components and applicable softwares / drivers whenever released by OEMs, without any cost to Bank. Any loss of the Bank in this regard shall be completely borne by the bidder. The Bank shall issue Letter of Intent / Confirmation Letter</p>	<p>We have inbuilt latest Anti-skimming solution available as per the all known type of skimming attacks. We will be making any changes if required at the later date as need comes. We cannot envisage what could happen and what changes needed which may take sometime for us to make changes. We request bank to look into this and provide a reasonable time to make changes if needed. Skimming is limited to Mag strip data and EMV, Contactless and Biometrics are not part of this skimming hence these should be kept out from the skimming scope. We wont be having any knowledge of evolving any such attacks if any.</p>	<p>Terms &amp; Conditions applicable as per RFP</p>
-----	---	------------	---	---	---

		<p>for installation of any such upgraded hardware / physical devices / components and applicable software or any standalone software after duly testing at its ATM-Lab. The rollout / installation of the upgrade (hardware and / or software, as applicable) should be done within the timeframe specified in the Letter of Intent / Confirmation Letter. A penalty of Rs.1,000 per day per non-complied machine shall be imposed for delay beyond the specified timeframe or for non-compliance of the Letter of Intent / Confirmation Letter.</p>		
--	--	--	--	--

161	i	Appendix E	<p>All endpoints should have anti-skimming devices / solutions, anti-shimming devices / solutions, anti-deep-insert-skimmers, any other device or solution etc. to prevent unauthorized reading and copying of card data (of card's magstripe or chip) from card-reader and contactless card reader, biometric data from biometric reader. Bidder to ensure that no cloning of card data to occur through machine. Bidder to upgrade the physical devices / components and applicable softwares / drivers whenever released by OEMs, without any cost to Bank. Any loss of the Bank in this regard shall be completely borne by the bidder. The Bank shall issue Letter of Intent / Confirmation Letter</p>	<p>We have inbuilt latest Anti-skimming solution available as per the all known type of skimming attacks. We will be making any changes if required at the later date as need comes. We cannot envisage what could happen and what changes needed which may take sometime for us to make changes. We request bank to look into this and provide a reasonable time to make changes if needed. Skimming is limited to Mag strip data and EMV, Contactless and Biometrics are not part of this skimming hence these should be kept out from the skimming scope. We wont be having any knowledge of evolving any such attacks if any.</p>	<p>Terms &amp; Conditions applicable as per RFP</p>
-----	---	------------	---	---	---



		<p>for installation of any such upgraded hardware / physical devices / components and applicable software or any standalone software after duly testing at its ATM-Lab. The rollout / installation of the upgrade (hardware and / or software, as applicable) should be done within the timeframe specified in the Letter of Intent / Confirmation Letter. A penalty of Rs.1,000 per day per non-complied machine shall be imposed for delay beyond the specified timeframe or for non-compliance of the Letter of Intent / Confirmation Letter.</p>		
--	--	--	--	--

161	i)	<p>Appendix E - Scope of Work  <b>INSTALLATION OF BRAND-NEW ATMS</b></p>	<p>All endpoints should have anti-skimming devices / solutions, anti-shimming devices / solutions, anti-deep-insert-skimmers, any other device or solution etc. to prevent unauthorized reading and copying of card data (of card's magstripe or chip) from card-reader and contactless card reader, biometric data from biometric reader. Bidder to ensure that no cloning of card data to occur through machine. Bidder to upgrade the physical devices / components and applicable softwares / drivers whenever released by OEMs, without any cost to Bank. Any loss of the Bank in this regard shall be completely borne by the bidder. The Bank shall issue Letter of Intent / Confirmation Letter</p>	<p>As per ATM OEM 2 - We have inbuilt latest Anti-skimming solution available as per the all known type of skimming attacks. We will be making any changes if required at the later date as need comes. We cannot envisage what could happen and what changes needed which may take sometime for us to make changes. We request bank to look into this and provide a reasonable time to make changes if needed. Skimming is limited to Mag strip data and EMV, Contactless and Biometrics are not part of this skimming hence these should be kept out from the skimming scope. We wont be having any knowledge of evolving any such attacks, if any.</p>	<p>Terms &amp; Conditions applicable as per RFP</p>
-----	----	--	---	---	---

		<p>for installation of any such upgraded hardware / physical devices / components and applicable software or any standalone software after duly testing at its ATM-Lab. The rollout / installation of the upgrade (hardware and / or software, as applicable) should be done within the timeframe specified in the Letter of Intent / Confirmation Letter. A penalty of Rs.1,000 per day per non-complied machine shall be imposed for delay beyond the specified timeframe or for non-compliance of the Letter of Intent / Confirmation Letter</p>		
--	--	---	--	--

161	j	Appendix E	<p>All endpoints should be able to give the status of cash dispensed or not dispensed with 100% surety and the same should be recorded in the Electronic Journal (EJ) / machine logs / System log / switch. Internal Cash slot camera should be present to capture the movement of cash. Video / Image analytics or algorithms can be developed to ascertain the dispensation of cash. Failure to determine the cash dispensation status, the disputed amount / chargeback claim with any penalty imposed on Bank for that disputed transaction, if any, involved in such un-sure transactions will be made good by the vendor. The Bank shall support the bidder, at its own</p>	<p>All different test cases to be tested as part of UAT. In case any issue with regard to MVS application handling to be corrected along with OEM testing. Request bank to look into the same. Also in case of any new fraud that will be discussed and next course of action to handle the same.</p>	<p>Terms &amp; Conditions applicable as per RFP</p>
-----	---	------------	---	---	---

		<p>discretion, for any development required in Bank's MVS Solution or Bank's Switch. In case of any incorrect dispensation due to faulty functioning of the machine, the vendor should make good the loss within 30 days from the date of reporting of incidents and take corrective measures immediately. The Bank should not suffer loss due to any defect of the machine. The Bank's decision with regard to faulty functioning of the machine will be final and binding on the bidder. In case the defect resolution requires development / R&amp;D (Research and Development) from OEM of the endpoint, the bidder should ensure that the OEM does the required development within</p>		
--	--	---	--	--

		<p>the stipulated time agreed by the Bank. A penalty of Rs. 1,000 per day per non-complied machine shall be applicable for delay after the agreed stipulated timeframe.</p>		
--	--	---	--	--

161	j	Appendix E	<p>All endpoints should be able to give the status of cash dispensed or not dispensed with 100% surety and the same should be recorded in the Electronic Journal (eJ) / machine logs / System log / switch. Internal Cash slot camera should be present to capture the movement of cash. Video / Image analytics or algorithms can be developed to ascertain the dispensation of cash. Failure to determine the cash dispensation status, the disputed amount / chargeback claim with any penalty imposed on Bank for that disputed transaction, if any, involved in such un-sure transactions will be made good by the vendor. The Bank shall support the bidder, at its own</p>	<p>All different test cases to be tested as part of UAT. In case any issue with regard to MVS application handling to be corrected along with OEM testing. Request bank to look into the same. Also in case of any new fraud that will be discussed and next course of action to handle the same.</p>	<p>Terms &amp; Conditions applicable as per RFP</p>
-----	---	------------	---	---	---

		<p>discretion, for any development required in Bank's MVS Solution or Bank's Switch. In case of any incorrect dispensation due to faulty functioning of the machine, the vendor should make good the loss within 30 days from the date of reporting of incidents and take corrective measures immediately. The Bank should not suffer loss due to any defect of the machine. The Bank's decision with regard to faulty functioning of the machine will be final and binding on the bidder. In case the defect resolution requires development / R&amp;D (Research and Development) from OEM of the endpoint, the bidder should ensure that the OEM does the required development within</p>		
--	--	---	--	--



		<p>the stipulated time agreed by the Bank. A penalty of Rs. 1,000 per day per non-complied machine shall be applicable for delay after the agreed stipulated timeframe.</p>		
--	--	---	--	--

161	j)	<p>Appendix E - Scope of Work  <b>INSTALLATION OF BRAND-NEW ATMS</b></p>	<p>All endpoints should be able to give the status of cash dispensed or not dispensed with 100% surety and the same should be recorded in the Electronic Journal (e) / machine logs / System log / switch. Internal Cash slot camera should be present to capture the movement of cash. Video / Image analytics or algorithms can be developed to ascertain the dispensation of cash. Failure to determine the cash dispensation status, the disputed amount / chargeback claim with any penalty imposed on Bank for that disputed transaction, if any, involved in such un-sure transactions will be made good by the vendor. The Bank shall support the bidder, at its own</p>	<p>As per ATM OEM 2 - All different test cases to be tested as part of UAT. In case any issue with regard to MVS application handling to be corrected along with OEM testing. Request bank to look into the same. Also in case of any new fraud that will be discussed and next course of action to handle the same.</p>	<p>Terms &amp; Conditions applicable as per RFP</p>
-----	----	--	--	--	---

		<p>discretion, for any development required in Bank's MVS Solution or Bank's Switch. In case of any incorrect dispensation due to faulty functioning of the machine, the vendor should make good the loss within 30 days from the date of reporting of incidents and take corrective measures immediately. The Bank should not suffer loss due to any defect of the machine. The Bank's decision with regard to faulty functioning of the machine will be final and binding on the bidder. In case the defect resolution requires development / R&amp;D (Research and Development) from OEM of the endpoint, the bidder should ensure that the OEM does the required development within</p>		
--	--	---	--	--

		<p>the stipulated time agreed by the Bank. A penalty of Rs. 1,000 per day per non-complied machine shall be applicable for delay after the agreed stipulated timeframe.</p>		
--	--	---	--	--

163	Appendix -E Scope of Work	Scope of Work	I. Record the power events in EJ / machine logs / system logs.	This is the integration to be done by MVS vendor at his software, we will provide the SNMP traps from UPS and he should take and integrate with ATM	Terms & Conditions applicable as per RFP
163	h)	BIOMETRIC READERS / DEVICES:	n) Vendor should make arrangement for Installation and maintenance of UPS with minimum 8 hours fast charging SMF / Lithium-ion battery backup. However, it is responsibility of the Vendor to arrange for uninterrupted power supply for ATM functioning. In areas where there is load shedding, the Vendor should arrange for alternate Power supply arrangements like DG set, solar power, etc.	Since the Bidder wouldn't know the locations, The Bidder request the Bank to keep it outside the scope and work on a mutually agreed cost for such units wherever and whenever they are required	Terms & Conditions applicable as per RFP

163	n.	Scope of Work - 1. (n)	Vendor should make arrangement for Installation and maintenance of UPS with minimum 8 hours fast charging SMF / Lithium-ion battery backup. However, it is responsibility of the Vendor to arrange for uninterrupted power supply for ATM functioning. In areas where there is load shedding, the Vendor should arrange for alternate Power supply arrangements like DG set, solar power, etc. The UPS should be integrated with the Endpoint such that the Endpoint is able to: - i. Distinguish power supply from Mains or UPS. ii. Shut down / sleep / hibernate gracefully (after completing any on-going transaction) when running on UPS power and the UPS	However, it is responsibility of the Vendor to arrange for uninterrupted power supply for ATM functioning. In areas where there is load shedding, the Vendor should arrange for alternate Power supply arrangements like DG set, solar power, etc.  Request bank to reimburse/share the cost for such alternate power supply arrangements or exclude these from the downtime.	Terms & Conditions applicable as per RFP
-----	----	---------------------------	--	---	--

		<p>battery charge is low (say 10%- or 15- minutes available backup). Endpoint should be able to “wake-up” and start working automatically when adequate charge is available, or mains power restored.</p> <p>iii. Record the power events in EJ / machine logs / system logs.</p> <p>iv. Monitor the power status (voltage / current etc.), UPS Battery percentage.</p> <p>v. Should be able to switch to UPS Power from Mains power when Mains power is fluctuating / low voltage etc. and back to mains power when its stable. The intension is to protect machine from power surges etc.</p> <p>vi. The above functionalities to be tested in the ATM Lab, so the UPS with minimum 8 hours fast</p>		
--	--	--	--	--

		charging SMF / Lithium-ion battery to be provided along with the machine.		
--	--	--	--	--



164	1 ( T )	INSTALLATION OF BRAND-NEW ATMS	<p>The Bank desires to install endpoints with the latest technologies. The Bidder is liable to bear the full cost of upgrading the Hardware, Software (including Operating System) for any future Operating System Patch, Operating System Upgrade, security patches, Regulatory compliances etc. which require the Hardware or Software of the endpoint to be upgraded. All Such upgrades shall be without any additional cost to the Bank for the entire contract period of 7 years and extensions thereof.</p>	<p>All upgrades shall be charges as per costs decided mutually by the parties</p>	<p>Terms &amp; Conditions applicable as per RFP</p>
-----	---------	--------------------------------	---	---	---

164	1 (t)	<p>Appendix E - Scope of Work  <b>INSTALLATION OF BRAND-NEW ATMS</b></p>	<p>ATMs deployed should comply with GOI, RBI, IBA, EMV, NPCI / NFS guidelines etc. If any new guidelines are issued by these organizations, the bidder / vendor shall arrange for its compliance / upgradation and bear the cost for the same. All upgradations (including but not limited to Security, network, site related digital security) will be done by the vendor free of cost. Any new type of Hardware (with associated software / drivers for that Hardware) in the endpoint will be done at mutually agreed price between the Bank and the vendor. For example, if the endpoint needs to be installed with extra Hardware such as QR code reader, Bar code</p>	<p>As per ATM OEM 2 - We will be complied to all regulatory and statutory compliance at the date of bid submission. Any future guideline on compliance and regulatory/statutory requirement cannot be envisaged at the current moment and hence we cannot envisage the impact of the same.</p> <p>Also any change in the standards used for NFC or biometric in the future may require the hardware to be changed. In such scenario's these hardware would be considered as new hardware and will be agreed at a mutually agreed price. Bank to acknowledge the same</p>	<p>Terms &amp; Conditions applicable as per RFP</p>
-----	-------	--	---	--	---

		<p>reader, ink-stain technology in cassettes etc., as per regulatory guidelines, such installations can be done at mutually agreed price between the Bank and the vendor. If the endpoint needs to be upgraded on operating system or any other component etc. which is already a part of the end point (like RAM, card reader, anti-skimming solutions, Biometric, contactless reader, new features in DVSS cameras etc.), this must be done by the vendor free of cost.</p>		
--	--	---	--	--

164	1 (t)	Appendix E - Scope of Work INSTALLATION OF BRAND-NEW ATMS	t) The Bank desires to install endpoints with the latest technologies. The Bidder is liable to bear the full cost of upgrading the Hardware, Software (including Operating System) for any future Operating System Patch, Operating System Upgrade, security patches, Regulatory compliances etc. which require the Hardware or Software of the endpoint to be upgraded. All Such upgrades shall be without any additional cost to the Bank for the entire contract period of 7 years and extensions thereof. Non-compliance by bidders shall attract penalty of Rs. 5,000 per day per endpoint from the end date advised by the Bank for compliance.	This should be on mutually agreeable commercial terms	<b>CORRIGENDUM:</b> t) The Bank desires to install endpoints with the latest technologies. The Bidder is liable to bear the full cost of upgrading the Hardware, Software (including Operating System) for any future Operating System Patch, Operating System Upgrade, security patches, Regulatory compliances etc. which require the Hardware or Software of the endpoint to be upgraded. All Such upgrades shall be without any additional cost to the Bank for the entire contract period of 7 years and extensions thereof. Non-compliance by bidders shall attract penalty of Rs. <del>5,000</del> 1,000/- per day per endpoint from the end date advised by the Bank for compliance. Therefore, it is recommended that bidders install endpoints with higher configurations than the minimum specifications mentioned in this RFP
-----	-------	--	---	---	--

		<p>Therefore, it is recommended that bidders install endpoints with higher configurations than the minimum specifications mentioned in this RFP</p>		
--	--	---	--	--

164	1 s	Appendix E	<p>ATMs deployed should comply with GOI, RBI, IBA, EMV, NPCI / NFS guidelines etc. If any new guidelines are issued by these organizations, the bidder / vendor shall arrange for its compliance / upgradation and bear the cost for the same. All upgradations (including but not limited to Security, network, site related digital security) will be done by the vendor free of cost. Any new type of Hardware (with associated software / drivers for that Hardware) in the endpoint will be done at mutually agreed price between the Bank and the vendor. For example, if the endpoint needs to be installed with extra Hardware such as QR code reader, Bar code</p>	<p>Bidder will be in compliance to all regulatory and statutory compliance at the date of bid submission. Any future guideline on compliance and regulatory/statutory requirement cannot be envisaged at the current moment and hence bidder cannot envisage the impact of the same.</p> <p>Also any change in the standards used for NFC or biometric in the future may require the hardware to be changed. In such scenario's these hardware would be considered as new hardware and will be agreed at a mutually agreed price. Bank to acknowledge the same</p>	Terms & Conditions applicable as per RFP
-----	-----	------------	---	--	--

		<p>reader, ink-stain technology in cassettes etc., as per regulatory guidelines, such installations can be done at mutually agreed price between the Bank and the vendor. If the endpoint needs to be upgraded on operating system or any other component etc. which is already a part of the end point (like RAM, card reader, anti-skimming solutions, Biometric, contactless reader, new features in DVSS cameras etc.), this must be done by the vendor free of cost.</p>		
--	--	---	--	--

164	1 s	Appendix E	<p>ATMs deployed should comply with GOI, RBI, IBA, EMV, NPCI / NFS guidelines etc. If any new guidelines are issued by these organizations, the bidder / vendor shall arrange for its compliance / upgradation and bear the cost for the same. All upgradations (including but not limited to Security, network, site related digital security) will be done by the vendor free of cost. Any new type of Hardware (with associated software / drivers for that Hardware) in the endpoint will be done at mutually agreed price between the Bank and the vendor. For example, if the endpoint needs to be installed with extra Hardware such as QR code reader, Bar code</p>	<p>Bidder will be in compliance to all regulatory and statutory compliance at the date of bid submission. Any future guideline on compliance and regulatory/statutory requirement cannot be envisaged at the current moment and hence bidder cannot envisage the impact of the same.</p> <p>Also any change in the standards used for NFC or biometric in the future may require the hardware to be changed. In such scenerio's these hardware would be considered as new hardware and will be agreed at a mutually agreed price. Bank to acknowledge the same</p>	<p>Terms &amp; Conditions applicable as per RFP</p>
-----	-----	------------	---	--	---



		<p>reader, ink-stain technology in cassettes etc., as per regulatory guidelines, such installations can be done at mutually agreed price between the Bank and the vendor. If the endpoint needs to be upgraded on operating system or any other component etc. which is already a part of the end point (like RAM, card reader, anti-skimming solutions, Biometric, contactless reader, new features in DVSS cameras etc.), this must be done by the vendor free of cost.</p>		
--	--	---	--	--

164	1 s	Appendix-E	<p>ATMs deployed should comply with RBI, IBA, EMV, NPCI/NFS guidelines. If any new guidelines are issued by these organizations, the bidder/vendor shall arrange for its compliance / upgradation and bear the cost for the same. The Bank desires to install ATMs with the latest technologies. The Bidder is liable to bear the full cost of upgrading the Hardware, Software (including Operating System) for any future Operating System Patch, Operating System Upgrade, security patches, Regulatory compliances etc. which require the Hardware or Software of the endpoint to be upgraded. All Such upgrades shall be without any additional cost to the</p>	<p>The Compliances as on date of installation shall be carried out by successful bidder, implementation of any future guidelines shall be mutually discussed between parties. Recurring penalty shall have capping as bidder cannot assume unlimited liability.</p>	<p><b>CORRIGENDUM:</b>  t) The Bank desires to install endpoints with the latest technologies. The Bidder is liable to bear the full cost of upgrading the Hardware, Software (including Operating System) for any future Operating System Patch, Operating System Upgrade, security patches, Regulatory compliances etc. which require the Hardware or Software of the endpoint to be upgraded. All Such upgrades shall be without any additional cost to the Bank for the entire contract period of 7 years and extensions thereof. Non-compliance by bidders shall attract penalty of Rs. <del>5,000</del> 1,000/- per day per endpoint from the end date advised by the Bank for compliance. Therefore, it is recommended that bidders install endpoints with higher configurations than the minimum specifications mentioned in this RFP</p>
-----	-----	------------	--	---	---

		<p>Bank for the entire contract period of 7 years and 3 years' extensions thereof. Non-compliance by bidders shall attract penalty of ₹ 5,000 per day per endpoint from the end date advised by the Bank for compliance. Therefore, it is recommended that bidders install ATMs with higher configurations than the minimum specifications mentioned in this RFP.</p>		
--	--	---	--	--

164	Appendix E	1 s	<p>ATMs deployed should comply with GOI, RBI, IBA, EMV, NPCI / NFS guidelines etc. If any new guidelines are issued by these organizations, the bidder / vendor shall arrange for its compliance / upgradation and bear the cost for the same. All upgradations (including but not limited to Security, network, site related digital security) will be done by the vendor free of cost. Any new type of Hardware (with associated software / drivers for that Hardware) in the endpoint will be done at mutually agreed price between the Bank and the vendor. For example, if the endpoint needs to be installed with extra Hardware such as QR code reader, Bar code</p>	<p>Bidder will be in compliance to all regulatory and statutory compliance at the date of bid submission. Any future guideline on compliance and regulatory/statutory requirement cannot be envisaged at the current moment and hence bidder cannot envisage the impact of the same.</p> <p>Also any change in the standards used for NFC or biometric in the future may require the hardware to be changed. In such scenario's these hardware would be considered as new hardware and will be agreed at a mutually agreed price. Bank to acknowledge the same</p>	<p>Terms &amp; Conditions applicable as per RFP</p>
-----	------------	-----	---	--	---

		<p>reader, ink-stain technology in cassettes etc., as per regulatory guidelines, such installations can be done at mutually agreed price between the Bank and the vendor. If the endpoint needs to be upgraded on operating system or any other component etc. which is already a part of the end point (like RAM, card reader, anti-skimming solutions, Biometric, contactless reader, new features in DVSS cameras etc.), this must be done by the vendor free of cost.</p>		
--	--	---	--	--

164	Appendix E	1 s	<p>ATMs deployed should comply with GOI, RBI, IBA, EMV, NPCI / NFS guidelines etc. If any new guidelines are issued by these organizations, the bidder / vendor shall arrange for its compliance / upgradation and bear the cost for the same. All upgradations (including but not limited to Security, network, site related digital security) will be done by the vendor free of cost. Any new type of Hardware (with associated software / drivers for that Hardware) in the endpoint will be done at mutually agreed price between the Bank and the vendor. For example, if the endpoint needs to be installed with extra Hardware such as QR code reader, Bar code</p>	<p>Bidder will be in compliance to all regulatory and statutory compliance at the date of bid submission. <b>Any future guideline on compliance and regulatory/statutory requirement cannot be envisaged at the current moment and hence bidder cannot envisage the impact of the same.</b></p> <p>Also any change in the standards used for NFC or biometric in the future may require the hardware to be changed. In such scenerio's these hardware would be considered as new hardware and will be agreed at a mutually agreed price. Bank to acknowledge the same</p>	<p>Terms &amp; Conditions applicable as per RFP</p>
-----	------------	-----	---	---	---

		<p>reader, ink-stain technology in cassettes etc., as per regulatory guidelines, such installations can be done at mutually agreed price between the Bank and the vendor. If the endpoint needs to be upgraded on operating system or any other component etc. which is already a part of the end point (like RAM, card reader, anti-skimming solutions, Biometric, contactless reader, new features in DVSS cameras etc.), this must be done by the vendor free of cost.</p>		
--	--	---	--	--

164	H (s, t)	BIOMETRIC READERS / DEVICES:	<p>s) ATMs deployed should comply with GOI, RBI, IBA, EMV, NPCI / NFS guidelines etc. If any new guidelines are issued by these organizations, the bidder / vendor shall arrange for its <u>compliance / upgradation and bear the cost for the same.</u> <u>All upgradations (including but not limited to Security, network, site related digital security) will be done by the vendor free of cost.</u> Any new type of Hardware (with associated software / drivers for that Hardware) in the endpoint will be done at mutually agreed price between the Bank and the vendor. For example, if the endpoint needs to be installed with extra Hardware such as QR code reader, Bar code</p>	<p>Any new or additional updates/upgrades (both hardware and software), OS System patches requirement that are warranted due to change in regulatory guidelines on the existing and/or new ATMs after execution of the Agreement shall be complied by the Vendor on mutually agreed terms.</p>	<p>Terms &amp; Conditions applicable as per RFP</p>
-----	----------	------------------------------	--	--	---



reader, ink-stain technology in cassettes etc., as per regulatory guidelines, such installations can be done at mutually agreed price between the Bank and the vendor. If the endpoint needs to be upgraded on operating system or any other component etc. which is already a part of the end point (like RAM, card reader, anti-skimming solutions, Biometric, contactless reader, new features in DVSS cameras etc.), this must be done by the vendor free of cost.

t) The Bank desires to install endpoints with the latest technologies. The Bidder is liable to bear the full cost of upgrading the Hardware, Software (including Operating System) for any future Operating System

Patch, Operating System Upgrade, security patches, Regulatory compliances etc. which require the Hardware or Software of the endpoint to be upgraded. All Such upgrades shall be without any additional cost to the Bank for the entire contract period of 7 years and extensions thereof. Non-compliance by bidders shall attract penalty of Rs. 5,000 per day per endpoint from the end date advised by the Bank for compliance.

Therefore, it is recommended that bidders install endpoints with higher configurations than the minimum specifications mentioned in this RFP.

164

h)

BIOMETRIC READERS /  
DEVICES:

t) The Bank desires to install endpoints with the latest technologies. The Bidder is liable to bear the full cost of upgrading the Hardware, Software (including Operating System) for any future Operating System Patch, Operating System Upgrade, security patches, Regulatory compliances etc. which require the Hardware or Software of the endpoint to be upgraded. All Such upgrades shall be without any additional cost to the Bank for the entire contract period of 7 years and extensions thereof. Non-compliance by bidders shall attract penalty of Rs. 5,000 per day per endpoint from the end date advised by the Bank for compliance.

The Bidder requests the Bank to exclude from the scope and work with the Bidder for a mutually agreeable price for the Hardware upgrades/RBI Compliances that are not known today

**CORRIGENDUM:**

t) The Bank desires to install endpoints with the latest technologies. The Bidder is liable to bear the full cost of upgrading the Hardware, Software (including Operating System) for any future Operating System Patch, Operating System Upgrade, security patches, Regulatory compliances etc. which require the Hardware or Software of the endpoint to be upgraded. All Such upgrades shall be without any additional cost to the Bank for the entire contract period of 7 years and extensions thereof. Non-compliance by bidders shall attract penalty of Rs. ~~5,000~~ 1,000/- per day per endpoint from the end date advised by the Bank for compliance. Therefore, it is recommended that bidders install endpoints with higher configurations than the minimum specifications mentioned in this RFP

		<p>Therefore, it is recommended that bidders install endpoints with higher configurations than the minimum specifications mentioned in this RFP.</p>		
--	--	--	--	--

164	t	Appendix-E	<p>The Bank desires to install endpoints with the latest technologies. The Bidder is liable to bear the full cost of upgrading the Hardware, Software (including Operating System) for any future Operating System Patch, Operating System Upgrade, security patches, Regulatory compliances etc. which require the Hardware or Software of the endpoint to be upgraded. All Such upgrades shall be without any additional cost to the Bank for the entire contract period of 7 years and extensions thereof. Non-compliance by bidders shall attract penalty of Rs. 5,000 per day per endpoint from the end date advised by the Bank for compliance.</p>	<p>We request bank to allow mutual agreed time line for any upgradation.</p> <p>We request bank to remove the penalty amount. There many similar penalty incorporated in RFP</p> <p>We also request bank to mutually agree additional cost for any upgradation</p>	<p><b>CORRIGENDUM:</b></p> <p>t) The Bank desires to install endpoints with the latest technologies. The Bidder is liable to bear the full cost of upgrading the Hardware, Software (including Operating System) for any future Operating System Patch, Operating System Upgrade, security patches, Regulatory compliances etc. which require the Hardware or Software of the endpoint to be upgraded. All Such upgrades shall be without any additional cost to the Bank for the entire contract period of 7 years and extensions thereof. Non-compliance by bidders shall attract penalty of Rs. <del>5,000</del> 1,000/- per day per endpoint from the end date advised by the Bank for compliance. Therefore, it is recommended that bidders install endpoints with higher configurations than the minimum specifications mentioned in this RFP</p>
-----	---	------------	---	--	---

		<p>Therefore, it is recommended that bidders install endpoints with higher configurations than the minimum specifications mentioned in this RFP.</p>		
--	--	--	--	--

165	(w)	Installation of ATM	Vendor to replace Old / Vandalized / Non-working / Problematic machine within 30 days from the date of communication by Bank or date of incident (whichever applicable) with a new one, without any cost to the Bank. Whenever such machine is being replaced with a new one, the following should be facilitated by the Vendor: -	Request bank to exclude cases where police inquiry is going on and has not granted vendor access to the site	<b>CORRIGENDUM:</b> Vendor to replace Old / Vandalized / Non-working / Problematic machine within 30 days from the date of communication by Bank or date of incident (whichever applicable) with a new one, without any cost to the Bank. <b>Reasonable relaxation in time may be provided by Bank, where the site is sealed by Law-enforcement Agency(ies).</b> Whenever such machine is being replaced with a new one, the following should be facilitated by the Vendor: -
-----	-----	---------------------	--	--	--

165	i	Hard disk	<p>Hard disk of old machine should be taken over in the custody by the owner Branch &amp; preserved in an envelope with the details of the machine written on the envelope like Terminal ID, its Serial Number, OEM Make, Vendor Name, Site Address, Date of Handover, Last transaction date of the machine, Disposal date (180 days from Handover date) etc. (format in Annexure-7). The Hard disk to be kept in Branch Custody for 6 months i.e., 180 days from the handover date. Details of the Hard disk to be entered into the Branch Document Register and shall be subjected to audits. After disposal date, if there is no customer disputed transaction data in the hard disk,</p>	Requesting the Bank to modify the scope from individual ATM to consolidate declaration	Terms & Conditions applicable as per RFP
-----	---	-----------	--	--	--



		<p>it should be degaussed after permission from Branch Manager and disposed off as per the e-waste policy. Degaussing is simply a demagnetizing process to erase a hard disk. It is required to keep the hard disk for 180 days since that Hard disk contains the EJ, DVSS Images, machine logs etc. of the machine which may be required to resolve customer disputed transactions. The Hard disk to be retained beyond 180 days in case it contains the details of any disputed transaction logs / images / eJ till that disputed transaction is resolved. Hence before degaussing and disposal, Branch should check for any disputed transactions</p>		
--	--	--	--	--

from Complain  
Management Dept.

165	ii	EPP	Encrypted Pin Pad (EPP) of old machine: - The EPP of the old machine should be broken off in front of Bank Official and disposed off as per e-waste policy immediately. No need to retain the EPP. (Format in Annexure-7)	Requesting the Bank to modify the scope from individual ATM to consolidate declaration	Terms & Conditions applicable as per RFP
166	1 ( y )	INSTALLATION OF BRAND-NEW ATMS	Bank reserves the right to close the machine at its discretion for non-compliance of regulatory guidelines.	Bank to provide reasonable notice to the Vendor to rectify any issue to the machine, not caused due to any fault and after the machine has passed the UAT checks.	Terms & Conditions applicable as per RFP
166		1z	If in case, the Bank desires to run ATMs on native application instead of MVS, bidder will provide native software, electronic Journal (ej) services, others related services, without any cost to Bank.	The price for Native Software stack and support for native software stack Should be agreed at a mutually agreed incremental price	Terms & Conditions applicable as per RFP. Please refer Scope of work Para no. 1 b), page 159.

167	1.1 c	Appendix E	<p>Bidder to ensure that the Original Equipment Manufacturer (OEM) Engineer to run all test cases as applicable to the OEM's Native ATM Application Software in the Multi-Vendor Software (MVS) environment and certify that the results in MVS environment is same as in OEM's Native ATM Application software. The discrepancies observed, if any, should be communicated to the Bank and the necessary fixes / patches to be developed and deployed within the stipulated timeline advised by the Bank. Any financial loss suffered by the Bank due to non-resolution of these discrepancies will be borne by the bidder. The decision</p>	<p>ATM OEM will ensure all test cases works as per expectation and proper status of the transaction. However when MVS comes into play, it will be the MVS vendor responsibility to test and confirm if they are working correctly and take help of OEM if the fault at the ATM OEM end and get it closed.</p> <p>Also for functionalities which require the MVS vendor to modify their application or needs development the bidder should not be penalised for the same.</p>	<p>Terms &amp; Conditions applicable as per RFP</p>
-----	-------	------------	---	--	---

of the Bank in this regard will be binding on the bidder. The Bank reserves the discretion to waive off the financial loss amount.

167	1.1 c	Appendix E	<p>Bidder to ensure that the Original Equipment Manufacturer (OEM) Engineer to run all test cases as applicable to the OEM's Native ATM Application Software in the Multi-Vendor Software (MVS) environment and certify that the results in MVS environment is same as in OEM's Native ATM Application software. The discrepancies observed, if any, should be communicated to the Bank and the necessary fixes / patches to be developed and deployed within the stipulated timeline advised by the Bank. Any financial loss suffered by the Bank due to non-resolution of these discrepancies will be borne by the bidder. The decision</p>	<p>ATM OEM will ensure all test cases works as per expectation and proper status of the transaction. However when MVS comes into play, it will be the MVS vendor responsibility to test and confirm if they are working correctly and take help of OEM if the fault at the ATM OEM end and get it closed.</p> <p>Also for functionalites which require the MVS vendor to modify their application or needs development the bidder should not be penalised for the same.</p>	<p>Terms &amp; Conditions applicable as per RFP</p>
-----	-------	------------	---	---	---

		<p>of the Bank in this regard will be binding on the bidder. The Bank reserves the discretion to waive off the financial loss amount.</p>		
--	--	---	--	--

167	1.1 c)	Appendix E - Scope of Work INSTALLATION OF BRAND-NEW ATMS	Bidder to ensure that the Original Equipment Manufacturer (OEM) Engineer to run all test cases as applicable to the OEM's Native ATM Application Software in the Multi-Vendor Software (MVS) environment and certify that the results in MVS environment is same as in OEM's Native ATM Application software. The discrepancies observed, if any, should be communicated to the Bank and the necessary fixes / patches to be developed and deployed within the stipulated timeline advised by the Bank. Any financial loss suffered by the Bank due to non-resolution of these discrepancies will be borne by the bidder. The decision	As per ATM OEM 2 - We will ensure all test cases works as per expectation and proper status of the transaction. However when MVS comes into play, it will be the MVS vendor responsibility to test and confirm if they are working correctly and take help of OEM if the fault at the ATM OEM end and get it closed.  Also for functionalities which require the MVS vendor to modify their application or needs development the bidder should not be penalized for the same.	Terms & Conditions applicable as per RFP
-----	--------	--	--	---	--



of the Bank in this regard will be binding on the bidder. The Bank reserves the discretion to waive off the financial loss amount.

167	1.2(a)	Electronic Journal (EJ)	Bidder shall be responsible for terminal availability to enable EJ pulling by the ATM Applicant (MVS) Vendor. The responsibility of EJ pulling is of MVS vendor however, Bidder shall provide support to MVS team for EJ pulling and coordinate with them on regular basis.	Bank / MVS vendor should provide the status of EJ pulled / EJ not pulled / EJ disconnected with Issues faced ATM ID wise. In the event of no information from the Bank / MVS, Bidder will not be responsible for EJ not pulled and will not accept any deduction.	Terms & Conditions applicable as per RFP
167	1.2(b)	Electronic Journal (EJ)	In case of settlement of any claim of the Cardholder by the Bank in the event of non-availability of EJ due to fault of the vendor(s), the Bank reserves the right to recover the amount of transaction claim, alongwith RFP FOR TOM P-XVII 13,500 ATMs Page 168 of 421 award / penalty / losses if any, from the Vendor. Banks' decision in this regard is final and binding to vendor(s).	Bidder shall not be liable for any EJ disconnected / Disputed / incomplete/ incorrect / unavailable Ejs	Terms & Conditions applicable as per RFP

167	Appendix E	1.1 c	<p>Bidder to ensure that the Original Equipment Manufacturer (OEM) Engineer to run all test cases as applicable to the OEM's Native ATM Application Software in the Multi-Vendor Software (MVS) environment and certify that the results in MVS environment is same as in OEM's Native ATM Application software. The discrepancies observed, if any, should be communicated to the Bank and the necessary fixes / patches to be developed and deployed within the stipulated timeline advised by the Bank. Any financial loss suffered by the Bank due to non-resolution of these discrepancies will be borne by the bidder. The decision</p>	<p>ATM OEM will ensure all test cases works as per expectation and proper status of the transaction. However when MVS comes into play, it will be the MVS vendor responsibility to test and confirm if they are working correctly and take help of OEM if the fault at the ATM OEM end and get it closed.</p> <p>Also for functionalities which require the MVS vendor to modify their application or needs development the bidder should not be penalised for the same.</p>	<p>Terms &amp; Conditions applicable as per RFP</p>
-----	------------	-------	---	--	---

		<p>of the Bank in this regard will be binding on the bidder. The Bank reserves the discretion to waive off the financial loss amount.</p>		
--	--	---	--	--

167	Appendix E	1.1 c	<p>Bidder to ensure that the Original Equipment Manufacturer (OEM) Engineer to run all test cases as applicable to the OEM's Native ATM Application Software in the Multi-Vendor Software (MVS) environment and certify that the results in MVS environment is same as in OEM's Native ATM Application software. The discrepancies observed, if any, should be communicated to the Bank and the necessary fixes / patches to be developed and deployed within the stipulated timeline advised by the Bank. Any financial loss suffered by the Bank due to non-resolution of these discrepancies will be borne by the bidder. The decision</p>	<p>ATM OEM will ensure all test cases works as per expectation and proper status of the transaction. However when MVS comes into play, it will be the MVS vendor responsibility to test and confirm if they are working correctly and take help of OEM if the fault at the ATM OEM end and get it closed.</p> <p>Also for functionalitites which require the MVS vendor to modify their application or needs development the bidder should not be penalised for the same.</p>	<p>Terms &amp; Conditions applicable as per RFP</p>
-----	------------	-------	---	---	---

of the Bank in this regard will be binding on the bidder. The Bank reserves the discretion to waive off the financial loss amount.

168	1.2	Electronic Journal (EJ):	c) The following penalties shall be applicable for non-performance / delayed performance of EJ related activities due to fault of the vendor(s). Banks' decision in this regard is final and binding to vendor(s). Bank shall levy a penalty of Rs. 1,000/- per instance in case of:	The Bidder request the Bank to reduce this penalty to Rs 200	<b>CORRIGENDUM:</b> c) The following penalties shall be applicable for non-performance / delayed performance of EJ related activities due to fault of the vendor(s). Banks' decision in this regard is final and binding to vendor(s). Bank shall levy a penalty of Rs. <del>1,000/-</del> 500/- per <del>instance</del> transaction per day in case of:
168	1.3	Provision of DVSS Images / Footages:	If the vendor fails to provide the DVSS footage within 1 day when required by the Bank (within 180 days of the incident), for any reason including settlement of complaints within a reasonable time, the vendor will be liable to pay a penalty of Rs. 1,000/= per instance or the amount of penalty / loss suffered by the Bank on account of non-availability of such DVSS footage, whichever is higher.	48- Hours	Terms & Conditions applicable as per RFP

168	1.3	Provision of DVSS Images / Footages:	b) Endpoint Provider shall arrange to store DVSS footages up to a period of 180 days. DVSS images backup and EJ Backup as and when required by the Bank and during preventive maintenance shall be done by the Vendor without any additional cost to the Bank.	Bidder Requested Bank to make the time lines to 90 Days	Terms & Conditions applicable as per RFP
168	1.2 - C	1.2 Electronic Journal (EJ)	The following penalties shall be applicable for non-performance / delayed performance of EJ related activities due to fault of the vendor(s). Banks' decision in this regard is final and binding to vendor(s). Bank shall levy a penalty of Rs. 1,000/- per instance in case of	EJ penalty to be revised to Rs 200/- per instance/per day	<b>CORRIGENDUM:</b> c) The following penalties shall be applicable for non-performance / delayed performance of EJ related activities due to fault of the vendor(s). Banks' decision in this regard is final and binding to vendor(s). Bank shall levy a penalty of <del>Rs. 1,000/-</del> Rs. 500/- per <del>instance</del> transaction per day in case of:



168	1.2 b) and c)	Appendix E - Scope of Work Electronic Journal (EJ)	<p>b) In case of settlement of any claim of the Cardholder by the Bank in the event of non-availability of EJ due to fault of the vendor(s), the Bank reserves the right to recover the amount of transaction claim, alongwith award / penalty / losses if any, from the Vendor. Banks' decision in this regard is final and binding to vendor(s).</p> <p>c) The following penalties shall be applicable for non-performance / delayed performance of EJ related activities due to fault of the vendor(s). Banks' decision in this regard is final and binding to vendor(s). Bank shall levy a penalty of Rs. 1,000/- per instance</p>	<p>As Bidder has to align the engineer physically at site for fetching the EJ, would request the Bank to make this TAT as T+3 days, so as to ensure that the settlement timelines are also not impacted. Additionally have an exclusion for cases such as force majeure, vandalism, spare requirements, etc.</p> <p>Also there should not be any penalty since the disputed amount itself is a large enough penalty.</p>	Terms & Conditions applicable as per RFP
-----	---------------	---	--	--	--

168	1.2(c)	Electronic Journal (EJ)	The following penalties shall be applicable for non-performance / delayed performance of EJ related activities due to fault of the vendor(s). Banks' decision in this regard is final and binding to vendor(s). Bank shall levy a penalty of Rs. 1,000/- per instance in case of:	MVS vendor to provide All ATM EJs (full day) to Bidder on SFTP for dispute resolution	<b>CORRIGENDUM:</b> The following penalties shall be applicable for non-performance / delayed performance of EJ related activities due to fault of the vendor(s). Banks' decision in this regard is final and binding to vendor(s). Bank shall levy a penalty of Rs. <del>1,000/-</del> <b>500/-</b> per instance <del>transaction</del> per day in case of:
168	1.3(b)	Provision of DVSS Images / Footages	Endpoint Provider shall arrange to store DVSS footages up to a period of 180 days. DVSS images backup and EJ Backup as and when required by the Bank and during preventive maintenance shall be done by the Vendor without any additional cost to the Bank.	DVSS images & EJ will be pulled by MVS vendor. Storage for 180 days also should be the MVS vendor responsibility.	<b>CORRIGENDUM:</b> <del>Endpoint Provider shall arrange to store DVSS footages up to a period of 180 days. DVSS images backup and EJ Backup as and when required by the Bank and during preventive maintenance shall be done by the Vendor without any additional cost to the Bank.</del> Bidder shall be responsible for availability of all cameras in working condition 24x7x365 as well as sufficient store space in HDD for storage for minimum 180 days. The responsibility of DVSS footages retrieving is of MVS vendor however, Bidder shall provide support to MVS team for retrieving of DVSS footage(s) and coordinate with them on regular basis.

168	1.3(c)	Provision of DVSS Images / Footages	If the vendor fails to provide the DVSS footage within 1 day when required by the Bank (within 180 days of the incident), for any reason including settlement of complaints within a reasonable time, the vendor will be liable to pay a penalty of Rs. 1,000/= per instance or the amount of penalty / loss suffered by the Bank on account of non-availability of such DVSS footage, whichever is higher.	Bidder shall not be liable for DVSS not available within 180 days.	<b>CORRIGENDUM:</b> If the vendor fails to provide the DVSS footage within 1 day when required by the Bank (within 180 days of the incident), for any reason including settlement of complaints within a reasonable time, the vendor will be liable to pay a penalty of Rs. <del>1,000/=</del> 500 per <del>instance</del> transaction or the amount of award / penalty / loss suffered by the Bank on account of non-availability of such DVSS footage, whichever is higher.
169	1.3	Provision of DVSS Images / Footages:	c) If the vendor fails to provide the DVSS footage within 1 day when required by the Bank (within 180 days of the incident), for any reason including settlement of complaints within a reasonable time, the vendor will be liable to pay a penalty of Rs. 1,000/= per instance or the amount of	The Bidder Request the Bank to provide 3 Days timeline to provide the DVSS Footage	<b>CORRIGENDUM:</b> If the vendor fails to provide the DVSS footage within 1 day when required by the Bank (within 180 days of the incident), for any reason including settlement of complaints within a reasonable time, the vendor will be liable to pay a penalty of Rs. <del>1,000/=</del> 500 per <del>instance</del> transaction or the amount of award / penalty / loss suffered by the Bank on account of non-availability of such DVSS footage, whichever is higher.

			penalty / loss suffered by the Bank on account of non-availability of such DVSS footage, whichever is higher.		
169	2.1	NETWORKING / CONNECTIVITY OF ATMS	The Endpoints have to be interfaced with Bank's BASE 24 switch. However, the Bank reserves the right to change the switching interface at any point of time. In such cases it will be binding upon the selected Bidder to provide the required support to commission the Endpoints with new switching interface without any additional cost to the Bank.	Any additional requirements from the bank including support to commission the endpoints with new switching interface shall be charged by the Vendor as mutually agreed by the Parties	Terms & Conditions applicable as per RFP

169	2.2	Offsite Endpoints: c) i.	Combination of any 2 different modes like Dual 4G / 5G SIM (Primary) with auto switch over between the 2 SIMs + VSAT (secondary) OR Broadband (primary) + Dual 4G / 5G SIM (Secondary) with auto switch over between the 2 SIMs OR any other combinations. Dual 4G / 5G SIM connectivity should be provided from two different services providers.	Dual 4G/5G links should be on Active-Active switchover to ensure quick switchover amongst the two 4G/5G links of the two separate Telcos/Service providers.	<b>CORRIGENDUM:</b> i. Combination of any 2 different modes like Dual 4G / 5G SIM (Primary) with auto switch over between the 2 SIMs + VSAT (secondary) OR Broadband (primary) + Dual 4G / 5G SIM (Secondary) with auto switch over between the 2 SIMs OR any other combinations. Dual 4G / 5G SIM connectivity should be provided from two different services providers. <b>Dual 4G / 5G links should be on Active-Active with auto switchover to ensure seamless auto switchover amongst the two 4G / 5G links of the two separate Telcos / Service providers.</b>
169	2.2	Offsite Endpoints: c) i.	Combination of any 2 different modes like Dual 4G / 5G SIM (Primary) with auto switch over between the 2 SIMs + VSAT (secondary) OR Broadband (primary) + Dual 4G / 5G SIM (Secondary) with auto switch over between the 2 SIMs OR any other combinations. Dual 4G / 5G SIM connectivity should be provided from two	As RBI guidelines, incase of the Broadband option there should not be local internet break out otherwise, it require high end SDWAN solution with NGFW, IPS, IDS solution.	<b>CORRIGENDUM:</b> i. Combination of any 2 different modes like Dual 4G / 5G SIM (Primary) with auto switch over between the 2 SIMs + VSAT (secondary) OR Broadband (primary) + Dual 4G / 5G SIM (Secondary) with auto switch over between the 2 SIMs OR any other combinations. Dual 4G / 5G SIM connectivity should be provided from two different services providers. <b>Dual 4G / 5G links should be on Active-Active with auto switchover to ensure seamless auto switchover amongst the two 4G /</b>

			different services providers.		5G links of the two separate Telcos / Service providers.
169	2.2	Offsite Endpoints: c) ii.	Wherever (i) is not feasible and only single mode option like only VSAT is available at a location, then combination of 2 different service providers like Hughes VSAT (primary) + Tata Nelco VSAT (secondary) etc. with auto switchover facility between the two VSATs shall be provided by Vendor.	who will be responsible for autofailover configuration and management, it should be with the front bidder or bank.	<b>CORRIGENDUM:</b> Wherever (i) is not feasible and only single mode option like only VSAT is available at a location, then <del>combination of 2 different service providers like Hughes VSAT (primary) + Tata Nelco VSAT (secondary) etc. with auto switchover facility between the two</del> <b>one VSAT in extended C Band shall be provided by Vendor.</b>

169	2.2	Offsite Endpoints-C- i	<p>Combination of any 2 different modes like Dual 4G / 5G SIM (Primary) with auto switch over between the 2 SIMs + VSAT (secondary) OR Broadband (primary) + Dual 4G / 5G SIM (Secondary) with auto switch over between the 2 SIMs OR any other combinations. Dual 4G / 5G SIM connectivity should be provided from two different services providers.</p>	<p>In case of 4G the private APN solution is always prefer over open Internet SIM, for the reasons,</p> <ol style="list-style-type: none"> <li>1. As per DOT guidelines, the open Internet SIM can not be used for M2M connectivity (like ATM). The SIM should be private APN SIM.</li> <li>2. Security- In private APN the traffic moves in closed user group and not exposed to Internet</li> <li>3. In private APN traffic will handover using MPLS last mile redundant infra which gives better experience than Open Internet SIM which used public Internet cloud for traffic handover.</li> </ol> <p>Hence requesting bank to amend the requirement as , "  <i>Combination of any 2 different modes like Dual 4G / 5G SIM (Primary) with auto switch over between the 2 SIMs + VSAT (secondary) OR Broadband (primary) + Dual 4G / 5G SIM (Secondary) with auto switch over between the 2 SIMs OR any other combinations. Dual 4G / 5G SIM connectivity should be provided from two different services providers and</i></p>	<p><b>CORRIGENDUM:</b></p> <p>i. Combination of any 2 different modes like Dual 4G / 5G SIM (Primary) with auto switch over between the 2 SIMs + VSAT (secondary) OR Broadband (primary) + Dual 4G / 5G SIM (Secondary) with auto switch over between the 2 SIMs OR any other combinations. Dual 4G / 5G SIM connectivity should be provided from two different services providers. <b>Dual 4G / 5G links should be on Active-Active with auto switchover to ensure seamless auto switchover amongst the two 4G / 5G links of the two separate Telcos / Service providers.</b></p>
-----	-----	------------------------	---	--	--

*should use private APN. The traffic from remote ATM should be delivered using backhaul infra between service provider HUB and Bank DC and DR."*



169	2.2	Offsite Endpoints-C- ii	<p>Wherever (i) is not feasible and only single mode option like only VSAT is available at a location, then combination of 2 different service providers like Hughes VSAT (primary) + Tata Nelco VSAT (secondary) etc. with auto switchover facility between the two VSATs shall be provided by Vendor</p>	<p>There will be a practical challenge in terms of space requirement/ roof Top permission for the dual VSAT installations at remote ATM. The Remote ATM roof-top/ground, in most cases do not have space for installation of two VSAT Terminals.</p> <p>Technically also there is a lot of challenge in fallback if the VSAT are from different service providers. As every service provider has different infra for VSAT connectivity and there is no scope mention in RFP, which service provider will configure and manged the fallback between two of the VSAT.</p> <p>The standalone VSAT is capable to provide 99.5% SLA. Hence requesting bank to remove the dual VSAT requirement and amend the clause as, "Wherever (i) is not feasible bidder can provision VSAT connectivity. "</p>	<p><b>CORRIGENDUM:</b> Wherever (i) is not feasible and only single mode option like only VSAT is available at a location, then <del>combination of 2 different service providers like Hughes VSAT (primary) + Tata Nelco VSAT (secondary) etc. with auto switchover facility between the two</del> <b>one VSAT in extended C Band shall be provided by Vendor.</b></p>
-----	-----	-------------------------	--	--	---

169	2.2	Offsite Endpoints c) i.	Combination of any 2 different modes like Dual 4G / 5G SIM (Primary) with auto switch over between the 2 SIMs + VSAT (secondary) OR Broadband (primary) + Dual 4G / 5G SIM (Secondary) with auto switch over between the 2 SIMs OR any other combinations. Dual 4G / 5G SIM connectivity should be provided from two different services providers.	The bidder recommend that the bank should update the clause asking for an active-active switchover with-in the dual 4G/5G links to be provided. This would not only provide a quick switchover when one goes down but will also help balance the network traffic.	<b>CORRIGENDUM:</b> i. Combination of any 2 different modes like Dual 4G / 5G SIM (Primary) with auto switch over between the 2 SIMs + VSAT (secondary) OR Broadband (primary) + Dual 4G / 5G SIM (Secondary) with auto switch over between the 2 SIMs OR any other combinations. Dual 4G / 5G SIM connectivity should be provided from two different services providers. <b>Dual 4G / 5G links should be on Active-Active with auto switchover to ensure seamless auto switchover amongst the two 4G / 5G links of the two separate Telcos / Service providers.</b>
169	2.2	Offsite Endpoints c) i.	Combination of any 2 different modes like Dual 4G / 5G SIM (Primary) with auto switch over between the 2 SIMs + VSAT (secondary) OR Broadband (primary) + Dual 4G / 5G SIM (Secondary) with auto switch over between the 2 SIMs OR any other combinations. Dual 4G / 5G SIM connectivity should be provided from two	In order to comply to RBI guidelines, the bidder requests the bank to update the cause as "As RBI guidelines, incase of the Broadband option there should not be local internet break out otherwise, it require high end SDWAN solution with NGFW, IPS, IDS solution.	<b>CORRIGENDUM:</b> i. Combination of any 2 different modes like Dual 4G / 5G SIM (Primary) with auto switch over between the 2 SIMs + VSAT (secondary) OR Broadband (primary) + Dual 4G / 5G SIM (Secondary) with auto switch over between the 2 SIMs OR any other combinations. Dual 4G / 5G SIM connectivity should be provided from two different services providers. <b>Dual 4G / 5G links should be on Active-Active with auto switchover to ensure seamless auto switchover amongst the two 4G /</b>

			different services providers.		5G links of the two separate Telcos / Service providers.
169	2.2	Offsite Endpoints c) i.	Combination of any 2 different modes like Dual 4G / 5G SIM (Primary) with auto switch over between the 2 SIMs + VSAT (secondary) OR Broadband (primary) + Dual 4G / 5G SIM (Secondary) with auto switch over between the 2 SIMs OR any other combinations. Dual 4G / 5G SIM connectivity should be provided from two different services providers.	Wherever existing site is being retained, the bidder requests he bank to allow the bidder to retain the current VSAT network to ensure smooth switchover with zero downtime and no IP address change is required.	<b>CORRIGENDUM:</b> i. Combination of any 2 different modes like Dual 4G / 5G SIM (Primary) with auto switch over between the 2 SIMs + VSAT (secondary) OR Broadband (primary) + Dual 4G / 5G SIM (Secondary) with auto switch over between the 2 SIMs OR any other combinations. Dual 4G / 5G SIM connectivity should be provided from two different services providers. <b>Dual 4G / 5G links should be on Active-Active with auto switchover to ensure seamless auto switchover amongst the two 4G / 5G links of the two separate Telcos / Service providers.</b>

169	2.2	Offsite Endpoints c) i.	<p>Combination of any 2 different modes like Dual 4G / 5G SIM (Primary) with auto switch over between the 2 SIMs + VSAT (secondary) OR Broadband (primary) + Dual 4G / 5G SIM (Secondary) with auto switch over between the 2 SIMs OR any other combinations. Dual 4G / 5G SIM connectivity should be provided from two different services providers.</p>	<p>In case of VSAT connectivity, the MSPs should split the network across the different Geographic hubs of the Service provider.</p>	<p><b>CORRIGENDUM:</b>  i. Combination of any 2 different modes like Dual 4G / 5G SIM (Primary) with auto switch over between the 2 SIMs + VSAT (secondary) OR Broadband (primary) + Dual 4G / 5G SIM (Secondary) with auto switch over between the 2 SIMs OR any other combinations. Dual 4G / 5G SIM connectivity should be provided from two different services providers. <b>Dual 4G / 5G links should be on Active-Active with auto switchover to ensure seamless auto switchover amongst the two 4G / 5G links of the two separate Telcos / Service providers.</b></p>
-----	-----	-------------------------	---	--	--

169	2.2	Offsite Endpoints c) i.	<p>Combination of any 2 different modes like Dual 4G / 5G SIM (Primary) with auto switch over between the 2 SIMs + VSAT (secondary) OR Broadband (primary) + Dual 4G / 5G SIM (Secondary) with auto switch over between the 2 SIMs OR any other combinations. Dual 4G / 5G SIM connectivity should be provided from two different services providers.</p>	<p>The bidder requests the bank to update the clause stating that the "The primary Dual 4G/5G link and the secondary VSAT link should be provided by the same service provider."</p> <p>This helps ensure</p> <ol style="list-style-type: none"> <li>1. Smooth switchover between the primary and secondary links</li> <li>2. Ensure 100% ownership for the site uptime with one vendor</li> <li>3. Also the dashboard to be provided to the bank will be one dashboard with one ownership to avoid conflicting reasons from two different vendors</li> <li>4. One ownership of deciding the auto failover configuration.</li> </ol>	<p><b>CORRIGENDUM:</b></p> <p>i. Combination of any 2 different modes like Dual 4G / 5G SIM (Primary) with auto switch over between the 2 SIMs + VSAT (secondary) OR Broadband (primary) + Dual 4G / 5G SIM (Secondary) with auto switch over between the 2 SIMs OR any other combinations. Dual 4G / 5G SIM connectivity should be provided from two different services providers. <b>Dual 4G / 5G links should be on Active-Active with auto switchover to ensure seamless auto switchover amongst the two 4G / 5G links of the two separate Telcos / Service providers.</b></p>
-----	-----	-------------------------	---	--	--

169	2.2	Offsite Endpoints c) i.	<p>Combination of any 2 different modes like Dual 4G / 5G SIM (Primary) with auto switch over between the 2 SIMs + VSAT (secondary) OR Broadband (primary) + Dual 4G / 5G SIM (Secondary) with auto switch over between the 2 SIMs OR any other combinations. Dual 4G / 5G SIM connectivity should be provided from two different services providers.</p>	<p>Suggestion : The bidder requests the bank to modify the clause by adding the lines given below. This will help the bank achieve its purpose of true redundant connectivity</p> <p>There should be two separate routers/CPE at the ATM site, one for Dual 4G/5G link and the other for the VSAT. This will ensure that any equipment failure does not lead to entire site going down.</p>	<p><b>CORRIGENDUM:</b></p> <p>i. Combination of any 2 different modes like Dual 4G / 5G SIM (Primary) with auto switch over between the 2 SIMs + VSAT (secondary) OR Broadband (primary) + Dual 4G / 5G SIM (Secondary) with auto switch over between the 2 SIMs OR any other combinations. Dual 4G / 5G SIM connectivity should be provided from two different services providers. <b>Dual 4G / 5G links should be on Active-Active with auto switchover to ensure seamless auto switchover amongst the two 4G / 5G links of the two separate Telcos / Service providers.</b></p>
-----	-----	-------------------------	---	---	--

169	2.2	Offsite Endpoints c) ii.	<p>Wherever (i) is not feasible and only single mode option like only VSAT is available at a location, then combination of 2 different service providers like Hughes VSAT (primary) + Tata Nelco VSAT (secondary) etc. with auto switchover facility between the two VSATs shall be provided by Vendor.</p>	<p>Wherever (i) is not feasible and only single mode option like only VSAT is available at a location, then the bidder requests the bank to allow MSP have one VSAT vendor who can provide a combination of 2 different VSATs (operating on geographically separate Hubs with auto switchover). This still serves the same purpose of the redundancy. Also, VSAT is anyways a secondary link.</p> <p>FOR providing 2 VSATs, there will be a practical challenge in terms of space requirement/ roof Top permission for the dual VSAT installations at remote ATM. The Remote ATM roof-top/ground, in most cases do not have space for installation of two VSAT Terminals.</p> <p>Technically also there is a lot of challenge in fallback if the VSAT are from different service providers. As every service provider has different infra for VSAT connectivity and there is no scope mention in RFP, which service provider will configure and manage the</p>	<p><b>CORRIGENDUM:</b>  Wherever (i) is not feasible and only single mode option like only VSAT is available at a location, then <del>combination of 2 different service providers like Hughes VSAT (primary) + Tata Nelco VSAT (secondary) etc. with auto switchover facility between the two</del> <b>one VSAT in extended C Band shall be provided by Vendor.</b></p>
-----	-----	--------------------------	---	--	--

			<p>fallback between two of the VSAT.</p> <p>The standalone VSAT is capable to provide 99.5% SLA. Hence requesting bank to remove the dual VSAT requirement and amend the clause as, "Wherever (i) is not feasible bidder can provision VSAT connectivity. "</p>	
--	--	--	---	--



169	2.2	Offsite Endpoints: c) i.	Combination of any 2 different modes like Dual 4G / 5G SIM (Primary) with auto switch over between the 2 SIMs + VSAT (secondary) OR Broadband (primary) + Dual 4G / 5G SIM (Secondary) with auto switch over between the 2 SIMs OR any other combinations. Dual 4G / 5G SIM connectivity should be provided from two different services providers.	Wherever existing site is being retained, the MSP should use the current VSAT network to ensure smooth switchover with zero downtime and no IP address change is required.	<b>CORRIGENDUM:</b> i. Combination of any 2 different modes like Dual 4G / 5G SIM (Primary) with auto switch over between the 2 SIMs + VSAT (secondary) OR Broadband (primary) + Dual 4G / 5G SIM (Secondary) with auto switch over between the 2 SIMs OR any other combinations. Dual 4G / 5G SIM connectivity should be provided from two different services providers. <b>Dual 4G / 5G links should be on Active-Active with auto switchover to ensure seamless auto switchover amongst the two 4G / 5G links of the two separate Telcos / Service providers.</b>
169	2.2	Offsite Endpoints: c) i.	Combination of any 2 different modes like Dual 4G / 5G SIM (Primary) with auto switch over between the 2 SIMs + VSAT (secondary) OR Broadband (primary) + Dual 4G / 5G SIM (Secondary) with auto switch over between the 2 SIMs OR any other combinations. Dual 4G / 5G SIM connectivity should be provided from two	In case of VSAT connectivity, the MSPs should split the network across the different Geographic hubs of the Service provider.	<b>CORRIGENDUM:</b> i. Combination of any 2 different modes like Dual 4G / 5G SIM (Primary) with auto switch over between the 2 SIMs + VSAT (secondary) OR Broadband (primary) + Dual 4G / 5G SIM (Secondary) with auto switch over between the 2 SIMs OR any other combinations. Dual 4G / 5G SIM connectivity should be provided from two different services providers. <b>Dual 4G / 5G links should be on Active-Active with auto switchover to ensure seamless auto switchover amongst the two 4G /</b>

			different services providers.		5G links of the two separate Telcos / Service providers.
169	2.2	Offsite Endpoints: c) i.	Combination of any 2 different modes like Dual 4G / 5G SIM (Primary) with auto switch over between the 2 SIMs + VSAT (secondary) OR Broadband (primary) + Dual 4G / 5G SIM (Secondary) with auto switch over between the 2 SIMs OR any other combinations. Dual 4G / 5G SIM connectivity should be provided from two different services providers.	The primary Dual 4G/5G link and the secondary VSAT link should be provided by the same service provider to ensure smooth switchover between the primary and secondary links and to ensure 100% ownership for the site uptime.	<b>CORRIGENDUM:</b> i. Combination of any 2 different modes like Dual 4G / 5G SIM (Primary) with auto switch over between the 2 SIMs + VSAT (secondary) OR Broadband (primary) + Dual 4G / 5G SIM (Secondary) with auto switch over between the 2 SIMs OR any other combinations. Dual 4G / 5G SIM connectivity should be provided from two different services providers. <b>Dual 4G / 5G links should be on Active-Active with auto switchover to ensure seamless auto switchover amongst the two 4G / 5G links of the two separate Telcos / Service providers.</b>

169	2.2	Offsite Endpoints: c) i.	Combination of any 2 different modes like Dual 4G / 5G SIM (Primary) with auto switch over between the 2 SIMs + VSAT (secondary) OR Broadband (primary) + Dual 4G / 5G SIM (Secondary) with auto switch over between the 2 SIMs OR any other combinations. Dual 4G / 5G SIM connectivity should be provided from two different services providers.	There should be two separate routers/CPE at the ATM site, one for Dual 4G/5G link and the other for the VSAT. This will ensure that any equipment failure does not lead to entire site going down.	<b>CORRIGENDUM:</b> i. Combination of any 2 different modes like Dual 4G / 5G SIM (Primary) with auto switch over between the 2 SIMs + VSAT (secondary) OR Broadband (primary) + Dual 4G / 5G SIM (Secondary) with auto switch over between the 2 SIMs OR any other combinations. Dual 4G / 5G SIM connectivity should be provided from two different services providers. <b>Dual 4G / 5G links should be on Active-Active with auto switchover to ensure seamless auto switchover amongst the two 4G / 5G links of the two separate Telcos / Service providers.</b>
169	2.2	Offsite Endpoints: c) i.	Combination of any 2 different modes like Dual 4G / 5G SIM (Primary) with auto switch over between the 2 SIMs + VSAT (secondary) OR Broadband (primary) + Dual 4G / 5G SIM (Secondary) with auto switch over between the 2 SIMs OR any other combinations. Dual 4G / 5G SIM connectivity should be provided from two	Dual 4G/5G links should be on Active-Active switchover to ensure quick switchover amongst the two 4G/5G links of the two separate Telcos/Service providers.	<b>CORRIGENDUM:</b> i. Combination of any 2 different modes like Dual 4G / 5G SIM (Primary) with auto switch over between the 2 SIMs + VSAT (secondary) OR Broadband (primary) + Dual 4G / 5G SIM (Secondary) with auto switch over between the 2 SIMs OR any other combinations. Dual 4G / 5G SIM connectivity should be provided from two different services providers. <b>Dual 4G / 5G links should be on Active-Active with auto switchover to ensure seamless auto switchover amongst the two 4G /</b>

			different services providers.		5G links of the two separate Telcos / Service providers.
169	2.2	Offsite Endpoints: c) i.	Combination of any 2 different modes like Dual 4G / 5G SIM (Primary) with auto switch over between the 2 SIMs + VSAT (secondary) OR Broadband (primary) + Dual 4G / 5G SIM (Secondary) with auto switch over between the 2 SIMs OR any other combinations. Dual 4G / 5G SIM connectivity should be provided from two different services providers.	As RBI guidelines, incase of the Broadband option there should not be local internet break out otherwise, it require high end SDWAN solution with NGFW, IPS, IDS solution.	<b>CORRIGENDUM:</b> i. Combination of any 2 different modes like Dual 4G / 5G SIM (Primary) with auto switch over between the 2 SIMs + VSAT (secondary) OR Broadband (primary) + Dual 4G / 5G SIM (Secondary) with auto switch over between the 2 SIMs OR any other combinations. Dual 4G / 5G SIM connectivity should be provided from two different services providers. <b>Dual 4G / 5G links should be on Active-Active with auto switchover to ensure seamless auto switchover amongst the two 4G / 5G links of the two separate Telcos / Service providers.</b>

169	2.2	Offsite Endpoints: c) i.	Combination of any 2 different modes like Dual 4G / 5G SIM (Primary) with auto switch over between the 2 SIMs + VSAT (secondary) OR Broadband (primary) + Dual 4G / 5G SIM (Secondary) with auto switch over between the 2 SIMs OR any other combinations. Dual 4G / 5G SIM connectivity should be provided from two different services providers.	Wherever existing site is being retained, the MSP should use the current VSAT network to ensure smooth switchover with zero downtime and no IP address change is required.	<b>CORRIGENDUM:</b> i. Combination of any 2 different modes like Dual 4G / 5G SIM (Primary) with auto switch over between the 2 SIMs + VSAT (secondary) OR Broadband (primary) + Dual 4G / 5G SIM (Secondary) with auto switch over between the 2 SIMs OR any other combinations. Dual 4G / 5G SIM connectivity should be provided from two different services providers. <b>Dual 4G / 5G links should be on Active-Active with auto switchover to ensure seamless auto switchover amongst the two 4G / 5G links of the two separate Telcos / Service providers.</b>
169	2.2	Offsite Endpoints: c) i.	Combination of any 2 different modes like Dual 4G / 5G SIM (Primary) with auto switch over between the 2 SIMs + VSAT (secondary) OR Broadband (primary) + Dual 4G / 5G SIM (Secondary) with auto switch over between the 2 SIMs OR any other combinations. Dual 4G / 5G SIM connectivity should be provided from two	In case of VSAT connectivity, the MSPs should split the network across the different Geographic hubs of the Service provider.	<b>CORRIGENDUM:</b> i. Combination of any 2 different modes like Dual 4G / 5G SIM (Primary) with auto switch over between the 2 SIMs + VSAT (secondary) OR Broadband (primary) + Dual 4G / 5G SIM (Secondary) with auto switch over between the 2 SIMs OR any other combinations. Dual 4G / 5G SIM connectivity should be provided from two different services providers. <b>Dual 4G / 5G links should be on Active-Active with auto switchover to ensure seamless auto switchover amongst the two 4G /</b>

			different services providers.		5G links of the two separate Telcos / Service providers.
169	2.2	Offsite Endpoints: c) i.	Combination of any 2 different modes like Dual 4G / 5G SIM (Primary) with auto switch over between the 2 SIMs + VSAT (secondary) OR Broadband (primary) + Dual 4G / 5G SIM (Secondary) with auto switch over between the 2 SIMs OR any other combinations. Dual 4G / 5G SIM connectivity should be provided from two different services providers.	The primary Dual 4G/5G link and the secondary VSAT link should be provided by the same service provider to ensure smooth switchover between the primary and secondary links and to ensure 100% ownership for the site uptime.	<b>CORRIGENDUM:</b> i. Combination of any 2 different modes like Dual 4G / 5G SIM (Primary) with auto switch over between the 2 SIMs + VSAT (secondary) OR Broadband (primary) + Dual 4G / 5G SIM (Secondary) with auto switch over between the 2 SIMs OR any other combinations. Dual 4G / 5G SIM connectivity should be provided from two different services providers. <b>Dual 4G / 5G links should be on Active-Active with auto switchover to ensure seamless auto switchover amongst the two 4G / 5G links of the two separate Telcos / Service providers.</b>

169	2.2	Offsite Endpoints: c) i.	Combination of any 2 different modes like Dual 4G / 5G SIM (Primary) with auto switch over between the 2 SIMs + VSAT (secondary) OR Broadband (primary) + Dual 4G / 5G SIM (Secondary) with auto switch over between the 2 SIMs OR any other combinations. Dual 4G / 5G SIM connectivity should be provided from two different services providers.	There should be two separate routers/CPE at the ATM site, one for Dual 4G/5G link and the other for the VSAT. This will ensure that any equipment failure does not lead to entire site going down.	<b>CORRIGENDUM:</b> i. Combination of any 2 different modes like Dual 4G / 5G SIM (Primary) with auto switch over between the 2 SIMs + VSAT (secondary) OR Broadband (primary) + Dual 4G / 5G SIM (Secondary) with auto switch over between the 2 SIMs OR any other combinations. Dual 4G / 5G SIM connectivity should be provided from two different services providers. <b>Dual 4G / 5G links should be on Active-Active with auto switchover to ensure seamless auto switchover amongst the two 4G / 5G links of the two separate Telcos / Service providers.</b>
169	2.2	Offsite Endpoints: c) ii.	Wherever (i) is not feasible and only single mode option like only VSAT is available at a location, then combination of 2 different service providers like Hughes VSAT (primary) + Tata Nelco VSAT (secondary) etc. with auto switchover facility between the two VSATs shall be provided by Vendor.	Wherever (i) is not feasible and only single mode option like only VSAT is available at a location, then combination of 2 different VSATs operating on geographically separate Hubs with auto switchover to be provided by the vendor.	<b>CORRIGENDUM:</b> Wherever (i) is not feasible and only single mode option like only VSAT is available at a location, then <del>combination of 2 different service providers like Hughes VSAT (primary) + Tata Nelco VSAT (secondary) etc. with auto switchover facility between the two</del> <b>one VSAT in extended C Band shall be provided by Vendor.</b>

169	2.2	Offsite Endpoints: c) ii.	Wherever (i) is not feasible and only single mode option like only VSAT is available at a location, then combination of 2 different service providers like Hughes VSAT (primary) + Tata Nelco VSAT (secondary) etc. with auto switchover facility between the two VSATs shall be provided by Vendor.	Wherever (i) is not feasible and only single mode option like only VSAT is available at a location, then combination of 2 different VSATs operating on geographically separate Hubs with auto switchover to be provided by the vendor.	<b>CORRIGENDUM:</b> Wherever (i) is not feasible and only single mode option like only VSAT is available at a location, then <del>combination of 2 different service providers like Hughes VSAT (primary) + Tata Nelco VSAT (secondary) etc. with auto switchover facility between the two</del> <b>one VSAT in extended C Band shall be provided by Vendor.</b>
-----	-----	---------------------------	--	--	---



169	2.2	Offsite Endpoints-C- i	<p>Combination of any 2 different modes like Dual 4G / 5G SIM (Primary) with auto switch over between the 2 SIMs + VSAT (secondary) OR Broadband (primary) + Dual 4G / 5G SIM (Secondary) with auto switch over between the 2 SIMs OR any other combinations. Dual 4G / 5G SIM connectivity should be provided from two different services providers.</p>	<p>Bidder requests the bank to amend the requirement as , "<i>Combination of any 2 different modes like Dual 4G / 5G SIM (Primary) with auto switch over between the 2 SIMs + VSAT (secondary) OR Broadband (primary) + Dual 4G / 5G SIM (Secondary) with auto switch over between the 2 SIMs OR any other combinations. Dual 4G / 5G SIM connectivity should be provided from two different services providers and should use private APN. The traffic from remote ATM should be delivered using backhaul infra between service provider HUB and Bank DC and DR.</i>"</p> <p><i>The private APN solution is always prefer over open Internet SIM, for the security &amp; compliance reasons,</i></p>	<p><b>CORRIGENDUM:</b></p> <p>i. Combination of any 2 different modes like Dual 4G / 5G SIM (Primary) with auto switch over between the 2 SIMs + VSAT (secondary) OR Broadband (primary) + Dual 4G / 5G SIM (Secondary) with auto switch over between the 2 SIMs OR any other combinations. Dual 4G / 5G SIM connectivity should be provided from two different services providers. <b>Dual 4G / 5G links should be on Active-Active with auto switchover to ensure seamless auto switchover amongst the two 4G / 5G links of the two separate Telcos / Service providers.</b></p>
-----	-----	------------------------	---	---	--

169	2.2	Offsite Endpoints-C- i	<p>Combination of any 2 different modes like Dual 4G / 5G SIM (Primary) with auto switch over between the 2 SIMs + VSAT (secondary) OR Broadband (primary) + Dual 4G / 5G SIM (Secondary) with auto switch over between the 2 SIMs OR any other combinations. Dual 4G / 5G SIM connectivity should be provided from two different services providers.</p>	<p>In case of 4G the private APN solution is always prefer over open Internet SIM, for the reasons,</p> <ol style="list-style-type: none"> <li>1. As per DOT guidelines, the open Internet SIM can not be used for M2M connectivity (like ATM). The SIM should be private APN SIM.</li> <li>2. Security- In private APN the traffic moves in closed user group and not exposed to Internet</li> <li>3. In private APN traffic will handover using MPLS last mile redundant infra which gives better experience than Open Internet SIM which used public Internet cloud for traffic handover.</li> </ol> <p>Hence requesting bank to amend the requirement as , "  <i>Combination of any 2 different modes like Dual 4G / 5G SIM (Primary) with auto switch over between the 2 SIMs + VSAT (secondary) OR Broadband (primary) + Dual 4G / 5G SIM (Secondary) with auto switch over between the 2 SIMs OR any other combinations. Dual 4G / 5G SIM connectivity should be provided from two different services providers and</i></p>	<p><b>CORRIGENDUM:</b></p> <p>i. Combination of any 2 different modes like Dual 4G / 5G SIM (Primary) with auto switch over between the 2 SIMs + VSAT (secondary) OR Broadband (primary) + Dual 4G / 5G SIM (Secondary) with auto switch over between the 2 SIMs OR any other combinations. Dual 4G / 5G SIM connectivity should be provided from two different services providers. <b>Dual 4G / 5G links should be on Active-Active with auto switchover to ensure seamless auto switchover amongst the two 4G / 5G links of the two separate Telcos / Service providers.</b></p>
-----	-----	------------------------	---	--	--

*should use private APN. The traffic from remote ATM should be delivered using backhaul infra between service provider HUB and Bank DC and DR."*

169	2.2	Offsite Endpoints-C- ii	<p>Wherever (i) is not feasible and only single mode option like only VSAT is available at a location, then combination of 2 different service providers like Hughes VSAT (primary) + Tata Nelco VSAT (secondary) etc. with auto switchover facility between the two VSATs shall be provided by Vendor</p>	<p>There will be a practical challenge in terms of space requirement/ roof Top permission for the dual VSAT installations at remote ATM. The Remote ATM roof-top/ground, in most cases do not have space for installation of two VSAT Terminals.</p> <p>Technically also there is a lot of challenge in fallback if the VSAT are from different service providers. As every service provider has different infra for VSAT connectivity and there is no scope mention in RFP, which service provider will configure and manged the fallback between two of the VSAT.</p> <p>The standalone VSAT is capable to provide 99.5% SLA. Hence requesting bank to remove the dual VSAT requirement and amend the clause as, "Wherever (i) is not feasible bidder can provision VSAT connectivity. "</p>	<p><b>CORRIGENDUM:</b> Wherever (i) is not feasible and only single mode option like only VSAT is available at a location, then <del>combination of 2 different service providers like Hughes VSAT (primary) + Tata Nelco VSAT (secondary) etc. with auto switchover facility between the two</del> <b>one VSAT in extended C Band shall be provided by Vendor.</b></p>
-----	-----	-------------------------	--	--	---

169	2.2	Offsite Endpoints-e	<p>The vendor should provide reliable and uninterrupted connectivity for ATMs.</p> <p>Using any of the last mile like leased line Fiber / Copper, RF, UBR, Dual 4G / 5G SIM {Dual 4G / 5G SIM connectivity should be provided from two different services providers}, VSAT or any upcoming newer technologies will also be acceptable subject to the clearance from Bank's Information Security Department (if not already done). Preference to Dual 4G / 5G SIM based connectivity or optical fibre may be given over VSAT. VSATs should be installed only at locations where Dual 4G / 5G SIM based connectivity is not available. Dual 4G</p>	<p>The point is contradict with the requirement mention in point no - 2.2 Offsite Endpoints-C-i page no 169 where bank has asked Dual 4G with VSAT / broadband. Hence requesting bank to amend the requirement as, "The vendor should provide reliable and uninterrupted connectivity for ATMs. Using any of the last mile like leased line Fiber / Copper, RF, UBR, Dual 4G / 5G SIM {Dual 4G / 5G SIM backup by VSAT as per the clause no 2.2 Offsite Endpoints-C-i."</p>	<p>Terms &amp; Conditions applicable as per RFP</p>
-----	-----	---------------------	--	---	---

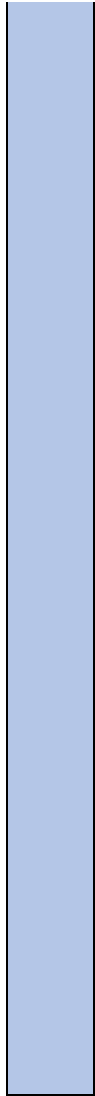

**/ 5G SIM based connectivity should be capable of providing multi-SIM connectivity which shall be delivered as per the Bank's requirement**

169	2.2	Offsite Endpoints-f	<p>The minimum bandwidth in case of VSAT last mile at each location for each ATM should be dedicated 64 Kbps with 100% concurrency (demand as on today) in extended C Band. Per ATM bandwidth requirement should match with the day-to-day requirement.</p>	<p>It is understood that the BW is required as 32 Kbps up and 32 kbps Down . Please confirm</p>	<p><b>CORRIGENDUM:</b>  <del>The minimum bandwidth in case of VSAT last mile at each location for each ATM should be dedicated 64 Kbps with 100% concurrency (demand as on today) in extended C Band. Per ATM bandwidth requirement should match with the day to day requirement.</del> <b>Minimum bandwidth in case of VSAT last mile at each location for each ATM should be dedicated 32 Kbps for upload &amp; download respectively with 100% concurrency (demand as on today). Further, if two or more ATMs are connected with same VSAT then bandwidth would be 64 kbps using (Number of ATMs X Bandwidth) formula. However, this is applicable for VSAT connectivity only. The dedicated bandwidth should be adequately provided to carry out transactions smoothly.</b></p>
-----	-----	---------------------	---	---	---

169	2.2	Offsite Endpoints-f	<p>The minimum bandwidth in case of VSAT last mile at each location for each ATM should be dedicated 64 Kbps with 100% concurrency (demand as on today) in extended C Band. Per ATM bandwidth requirement should match with the day-to-day requirement.</p>	<p>The KU band VSAT is capable to provide 99.5% uptime at remotest location. The Extended C band is recommended at the locations having high rain fall. Hence requesting bank to amend the clause as,  "The minimum bandwidth in case of VSAT last mile at each location for each ATM should be dedicated 64 Kbps with 100% concurrency (demand as on today) in combination of KU and extended c band.  minimum 5% VSAT should be installed in Extended C band. "</p>	<p><b>CORRIGENDUM:</b>  <del>The minimum bandwidth in case of VSAT last mile at each location for each ATM should be dedicated 64 Kbps with 100% concurrency (demand as on today) in extended C Band. Per ATM bandwidth requirement should match with the day to day requirement.</del> <b>Minimum bandwidth in case of VSAT last mile at each location for each ATM should be dedicated 32 Kbps for upload &amp; download respectively with 100% concurrency (demand as on today). Further, if two or more ATMs are connected with same VSAT then bandwidth would be 64 kbps using (Number of ATMs X Bandwidth) formula. However, this is applicable for VSAT connectivity only. The dedicated bandwidth should be adequately provided to carry out transactions smoothly.</b></p>
-----	-----	---------------------	---	---	---



169	2.2	Offsite Endpoints-f	<p>The minimum bandwidth in case of VSAT last mile at each location for each ATM should be dedicated 64 Kbps with 100% concurrency (demand as on today) in extended C Band. Per ATM bandwidth requirement should match with the day-to-day requirement.</p>	<p>The KU band VSAT is capable to provide 99.5% uptime at remotest location. The Extended C band is recommended at the locations having high rain fall. Hence requesting bank to amend the clause as,  "The minimum bandwidth in case of VSAT last mile at each location for each ATM should be dedicated 64 Kbps with 100% concurrency (demand as on today) in combination of KU and extended c band.  minimum 5% VSAT should be installed in Extended C band. "</p>	<p><b>CORRIGENDUM:</b>  <del>The minimum bandwidth in case of VSAT last mile at each location for each ATM should be dedicated 64 Kbps with 100% concurrency (demand as on today) in extended C Band. Per ATM bandwidth requirement should match with the day to day requirement.</del> <b>Minimum bandwidth in case of VSAT last mile at each location for each ATM should be dedicated 32 Kbps for upload &amp; download respectively with 100% concurrency (demand as on today). Further, if two or more ATMs are connected with same VSAT then bandwidth would be 64 kbps using (Number of ATMs X Bandwidth) formula. However, this is applicable for VSAT connectivity only. The dedicated bandwidth should be adequately provided to carry out transactions smoothly.</b></p>
-----	-----	---------------------	---	---	---

169	2.2	Offsite Endpoints-f	<p>The minimum bandwidth in case of VSAT last mile at each location for each ATM should be dedicated 64 Kbps with 100% concurrency (demand as on today) in extended C Band. Per ATM bandwidth requirement should match with the day-to-day requirement.</p>	<p>It is understood that the BW is required as 32 Kbps up and 32 kbps Down . Please confirm</p>	<p><b>CORRIGENDUM:</b>  <del>The minimum bandwidth in case of VSAT last mile at each location for each ATM should be dedicated 64 Kbps with 100% concurrency (demand as on today) in extended C Band. Per ATM bandwidth requirement should match with the day to day requirement.</del> <b>Minimum bandwidth in case of VSAT last mile at each location for each ATM should be dedicated 32 Kbps for upload &amp; download respectively with 100% concurrency (demand as on today). Further, if two or more ATMs are connected with same VSAT then bandwidth would be 64 kbps using (Number of ATMs X Bandwidth) formula. However, this is applicable for VSAT connectivity only. The dedicated bandwidth should be adequately provided to carry out transactions smoothly.</b></p>
-----	-----	---------------------	---	---	---

169	1.3 (c)	Appendix E - Scope of Work Provision of DVSS Images / Footages	If the vendor fails to provide the DVSS footage within 1 day when required by the Bank (within 180 days of the incident), for any reason including settlement of complaints within a reasonable time, the vendor will be liable to pay a penalty of Rs. 1,000/= per instance or the amount of penalty / loss suffered by the Bank on account of non-availability of such DVSS footage, whichever is higher.	As Bidder has to align the engineer physically at site for fetching the EJ, would request the Bank to make this TAT as T+3 days so as to ensure that the settlement timelines are also not impacted. Additionally have an exclusion for cases such as force majeure, vandalism, spare requirements, etc. Also there should not be any penalty since the disputed amount itself is a large enough penalty.	<b>CORRIGENDUM:</b> If the vendor fails to provide the DVSS footage within 1 day when required by the Bank (within 180 days of the incident), for any reason including settlement of complaints within a reasonable time, the vendor will be liable to pay a penalty of Rs. <del>1,000/=</del> <b>500</b> per <del>instance</del> <b>transaction</b> or the amount of <b>award</b> / penalty / loss suffered by the Bank on account of non-availability of such DVSS footage, whichever is higher.
-----	---------	---	---	---	---

169	2. NETWORKING / CONNECTIVITY OF ATMS: 2.2 Offsite Endpoints: c)		c) If the vendor fails to provide the DVSS footage within 1 day when required by the Bank (within 180 days of the incident), for any reason including settlement of complaints within a reasonable time, the vendor will be liable to pay a penalty of Rs. 1,000/= per instance or the amount of penalty / loss suffered by the Bank on account of non-availability of such DVSS footage, whichever is higher.	Footage submission timeframe should be as per regulator guidelines of resolving dispute onus/offus.	<b>CORRIGENDUM:</b> If the vendor fails to provide the DVSS footage within 1 day when required by the Bank (within 180 days of the incident), for any reason including settlement of complaints within a reasonable time, the vendor will be liable to pay a penalty of Rs. <del>1,000/=</del> 500 per instance transaction or the amount of award / penalty / loss suffered by the Bank on account of non-availability of such DVSS footage, whichever is higher.
-----	--	--	--	---	---

169	2.2 ( c)-i.	Appendix E - Scope of Work - Networking and Connectivity of ATMs	<p>Combination of any 2 different modes like Dual 4G / 5G SIM (Primary) with auto switch over between the 2 SIMs + VSAT (secondary) OR Broadband (primary) + Dual 4G / 5G SIM (Secondary) with auto switch over between the 2 SIMs OR any other combinations. Dual 4G / 5G SIM connectivity should be provided from two different services providers.</p>	<p>As per Network Service Provider 1 - Dual 4G/5G links should be on Active-Active switchover to ensure quick switchover amongst the two 4G/5G links of the two separate Telcos/Service providers.</p> <p>As RBI guidelines, incase of the Broadband option there should not be local internet break out otherwise, it require high end SDWAN solution with NGFW, IPS, IDS solution.</p> <p>Accordingly, we request the Bank for allowing the below recommendations:</p> <ol style="list-style-type: none"> <li>1. Wherever existing site is being retained, the MSP should use the current VSAT network to ensure smooth switchover with zero downtime and no IP address change is required.</li> <li>2. In case of VSAT connectivity, Bidder shall split the network across the different Geographic hubs of the Service Provider.</li> <li>3. The primary Dual 4G/5G link and the secondary VSAT link should be provided by the</li> </ol>	<p><b>CORRIGENDUM:</b></p> <p>i. Combination of any 2 different modes like Dual 4G / 5G SIM (Primary) with auto switch over between the 2 SIMs + VSAT (secondary) OR Broadband (primary) + Dual 4G / 5G SIM (Secondary) with auto switch over between the 2 SIMs OR any other combinations. Dual 4G / 5G SIM connectivity should be provided from two different services providers. <b>Dual 4G / 5G links should be on Active-Active with auto switchover to ensure seamless auto switchover amongst the two 4G / 5G links of the two separate Telcos / Service providers.</b></p>
-----	-------------	--	---	---	--

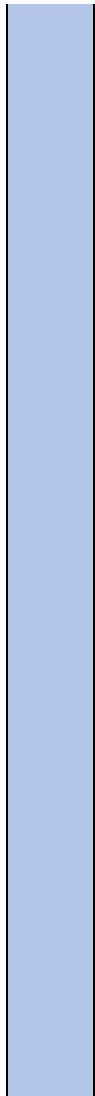

same service provider to ensure smooth switchover between the primary and secondary links and to ensure 100% ownership for the site uptime.

4. There shall be two separate routers/CPE at the ATM site, one for Dual 4G/5G link and the other for the VSAT. This will ensure that any equipment failure does not lead to entire site going down.

169	2.2 ( c)-i.	Appendix E - Scope of Work - Networking and Connectivity of ATMs	<p>Combination of any 2 different modes like Dual 4G / 5G SIM (Primary) with auto switch over between the 2 SIMs + VSAT (secondary) OR Broadband (primary) + Dual 4G / 5G SIM (Secondary) with auto switch over between the 2 SIMs OR any other combinations. Dual 4G / 5G SIM connectivity should be provided from two different services providers.</p>	<p>As per Network Service Provider 2 - As per DOT guidelines, the open Internet SIM can not be used for M2M connectivity (like ATM). The SIM should be private APN SIM. Hence, requesting bank to amend the requirement as :</p> <p><i>"Combination of any 2 different modes like Dual 4G / 5G SIM (Primary) with auto switch over between the 2 SIMs + VSAT (secondary) OR Broadband (primary) + Dual 4G / 5G SIM (Secondary) with auto switch over between the 2 SIMs OR any other combinations. Dual 4G / 5G SIM connectivity should be provided from two different services providers and should use private APN. The traffic from remote ATM should be delivered using backhaul infra between service provider HUB and Bank DC and DR."</i></p>	<p><b>CORRIGENDUM:</b></p> <p>i. Combination of any 2 different modes like Dual 4G / 5G SIM (Primary) with auto switch over between the 2 SIMs + VSAT (secondary) OR Broadband (primary) + Dual 4G / 5G SIM (Secondary) with auto switch over between the 2 SIMs OR any other combinations. Dual 4G / 5G SIM connectivity should be provided from two different services providers. <b>Dual 4G / 5G links should be on Active-Active with auto switchover to ensure seamless auto switchover amongst the two 4G / 5G links of the two separate Telcos / Service providers.</b></p>
-----	-------------	--	---	--	--

169	2.2 (c i)	Offsite Endpoints	<p>Combination of any 2 different modes like Dual 4G / 5G SIM (Primary) with auto switch over between the 2 SIMs + VSAT (secondary) OR Broadband (primary) + Dual 4G / 5G SIM (Secondary) with auto switch over between the 2 SIMs OR any other combinations. Dual 4G / 5G SIM connectivity should be provided from two different services providers.</p>	<p>As per DOT guidelines, the open Internet SIM can not be used for M2M connectivity (like ATM). The SIM should be private APN SIM. Hence requesting bank to amend the requirement as , " <i>Combination of any 2 different modes like Dual 4G / 5G SIM (Primary) with auto switch over between the 2 SIMs + VSAT (secondary) OR Broadband (primary) + Dual 4G / 5G SIM (Secondary) with auto switch over between the 2 SIMs OR any other combinations. Dual 4G / 5G SIM connectivity should be provided from two different services providers and should use private APN. The traffic from remote ATM should be delivered using backhaul infra between service provider HUB and Bank DC and DR.</i>"</p>	<p><b>CORRIGENDUM:</b>  i. Combination of any 2 different modes like Dual 4G / 5G SIM (Primary) with auto switch over between the 2 SIMs + VSAT (secondary) OR Broadband (primary) + Dual 4G / 5G SIM (Secondary) with auto switch over between the 2 SIMs OR any other combinations. Dual 4G / 5G SIM connectivity should be provided from two different services providers. <b>Dual 4G / 5G links should be on Active-Active with auto switchover to ensure seamless auto switchover amongst the two 4G / 5G links of the two separate Telcos / Service providers.</b></p>
-----	-----------	-------------------	---	---	--



169	2.2 (c ii)	Offsite Endpoints	<p>Wherever (i) is not feasible and only single mode option like only VSAT is available at a location, then combination of 2 different service providers like Hughes VSAT (primary) + Tata Nelco VSAT (secondary) etc. with auto switchover facility between the two VSATs shall be provided by Vendor</p>	<p>There will be a practical challenge in terms of space requirement/ roof Top permission for the dual VSAT installations at remote ATM. The Remote ATM roof-top/ground, in most cases do not have space for installation of two VSAT Terminals.</p> <p>Technically also there is a lot of challenge in fallback if the VSAT are from different service providers. As every service provider has different infra for VSAT connectivity and there is no scope mention in RFP, which service provider will configure and managed the fallback between two of the VSAT.</p> <p>The standalone VSAT is capable to provide 99.5% SLA. Hence requesting bank to remove the dual VSAT requirement and amend the clause as, "Wherever (i) is not feasible bidder can provision VSAT connectivity. "</p>	<p><b>CORRIGENDUM:</b> Wherever (i) is not feasible and only single mode option like only VSAT is available at a location, then <del>combination of 2 different service providers like Hughes VSAT (primary) + Tata Nelco VSAT (secondary) etc. with auto switchover facility between the two</del> <b>one VSAT in extended C Band shall be provided by Vendor.</b></p>
-----	------------	-------------------	--	---	---

169	2.2 (e)	Offsite Endpoints	<p>The vendor should provide reliable and uninterrupted connectivity for ATMs.</p> <p>Using any of the last mile like leased line Fiber / Copper, RF, UBR, Dual 4G / 5G SIM {Dual 4G / 5G SIM connectivity should be provided from two different services providers}, VSAT or any upcoming newer technologies will also be acceptable subject to the clearance from Bank's Information Security Department (if not already done). Preference to Dual 4G / 5G SIM based connectivity or optical fibre may be given over VSAT. VSATs should be installed only at locations where Dual 4G / 5G SIM based connectivity is not available. Dual 4G</p>	<p>The point is contradict with the requirement mention in point no - 2.2 Offsite Endpoints-C-i page no 169 where bank has asked Dual 4G with VSAT / broadband. Hence requesting bank to amend the requirement as, "The vendor should provide reliable and uninterrupted connectivity for ATMs. Using any of the last mile like leased line Fiber / Copper, RF, UBR, Dual 4G / 5G SIM {Dual 4G / 5G SIM backup by VSAT as per the clause no 2.2 Offsite Endpoints-C-i."</p>	<p>Terms &amp; Conditions applicable as per RFP</p>
-----	---------	-------------------	--	---	---

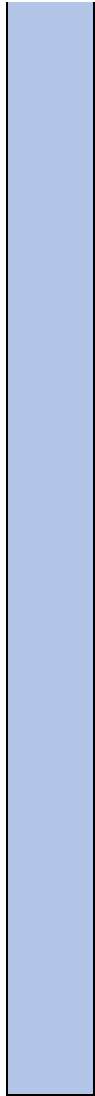

**/ 5G SIM based connectivity should be capable of providing multi-SIM connectivity which shall be delivered as per the Bank's requirement**

169	2.2 (f)	Offsite Endpoints	<p>The minimum bandwidth in case of VSAT last mile at each location for each ATM should be dedicated 64 Kbps with 100% concurrency (demand as on today) in extended C Band. Per ATM bandwidth requirement should match with the day-to-day requirement.</p>	<p>It is understood that the BW is required as 32 Kbps up and 32 kbps Down . Please confirm</p>	<p><b>CORRIGENDUM:</b>  <del>The minimum bandwidth in case of VSAT last mile at each location for each ATM should be dedicated 64 Kbps with 100% concurrency (demand as on today) in extended C Band. Per ATM bandwidth requirement should match with the day to day requirement.</del> <b>Minimum bandwidth in case of VSAT last mile at each location for each ATM should be dedicated 32 Kbps for upload &amp; download respectively with 100% concurrency (demand as on today). Further, if two or more ATMs are connected with same VSAT then bandwidth would be 64 kbps using (Number of ATMs X Bandwidth) formula. However, this is applicable for VSAT connectivity only. The dedicated bandwidth should be adequately provided to carry out transactions smoothly.</b></p>
-----	---------	-------------------	---	---	---

169	2.2 (f)	Offsite Endpoints	<p>The minimum bandwidth in case of VSAT last mile at each location for each ATM should be dedicated 64 Kbps with 100% concurrency (demand as on today) in extended C Band. Per ATM bandwidth requirement should match with the day-to-day requirement.</p>	<p>The KU band VSAT is capable to provide 99.5% uptime at remotest location. The Extended C band is recommended at the locations having high rain fall. Hence requesting bank to amend the clause as,  "The minimum bandwidth in case of VSAT last mile at each location for each ATM should be dedicated 64 Kbps with 100% concurrency (demand as on today) in combination of KU and extended c band. minimum 5% VSAT should be installed in Extended C band. "</p>	<p><b>CORRIGENDUM:</b>  <del>The minimum bandwidth in case of VSAT last mile at each location for each ATM should be dedicated 64 Kbps with 100% concurrency (demand as on today) in extended C Band. Per ATM bandwidth requirement should match with the day to day requirement.</del> <b>Minimum bandwidth in case of VSAT last mile at each location for each ATM should be dedicated 32 Kbps for upload &amp; download respectively with 100% concurrency (demand as on today). Further, if two or more ATMs are connected with same VSAT then bandwidth would be 64 kbps using (Number of ATMs X Bandwidth) formula. However, this is applicable for VSAT connectivity only. The dedicated bandwidth should be adequately provided to carry out transactions smoothly.</b></p>
-----	---------	-------------------	---	--	---

169	2.2 (g)	NETWORKING / CONNECTIVITY OF ATMS	Any software or application upgradation or network security requirements or application demands the bandwidth upgradation, the same should be made adequately available at no additional cost to the Bank to cater to the day-to-day requirement within the contract period. The same is applicable for other last mile also	Any additional upgrades or network security requirements shall be charged by the Vendor as mutually agreed by the Parties	Terms & Conditions applicable as per RFP
169	2.2 C (I & ii)		The Vendor should provide Integrated Dual Modes of connectivity for each ATM with Primary and Secondary mode of connectivity. The Switchover from Primary to Secondary and vice-verse should be automatic such that no connectivity disruption occurs. Dual Mode connectivity means: -	Network Connectivity , Is two sets of dual Sim connectivity required . If VSAT is the only mode are two different types on same rooftop required ?	Terms & Conditions applicable as per RFP

169	2.2 c) i.	Offsite Endpoints	<p>Combination of any 2 different modes like Dual 4G / 5G SIM (Primary) with auto switch over between the 2 SIMs + VSAT (secondary) OR Broadband (primary) + Dual 4G / 5G SIM (Secondary) with auto switch over between the 2 SIMs OR any other combinations. Dual 4G / 5G SIM connectivity should be provided from two different services providers.</p>	<p>Dual 4G/5G links should be on Active-Active switchover to ensure quick switchover amongst the two 4G/5G links of the two separate Telcos/Service providers. As RBI guidelines, incase of the Broadband option there should not be local internet break out otherwise, it require high end SDWAN solution with NGFW, IPS, IDS solution.</p>	<p><b>CORRIGENDUM:</b> i. Combination of any 2 different modes like Dual 4G / 5G SIM (Primary) with auto switch over between the 2 SIMs + VSAT (secondary) OR Broadband (primary) + Dual 4G / 5G SIM (Secondary) with auto switch over between the 2 SIMs OR any other combinations. Dual 4G / 5G SIM connectivity should be provided from two different services providers. <b>Dual 4G / 5G links should be on Active-Active with auto switchover to ensure seamless auto switchover amongst the two 4G / 5G links of the two separate Telcos / Service providers.</b></p>
169	2.2 c) i.	Offsite Endpoints	<p>Combination of any 2 different modes like Dual 4G / 5G SIM (Primary) with auto switch over between the 2 SIMs + VSAT (secondary) OR Broadband (primary) + Dual 4G / 5G SIM (Secondary) with auto switch over between the 2 SIMs OR any other combinations. Dual 4G / 5G SIM connectivity should be provided from two</p>	<p>Wherever existing site is being retained, the MSP should use the current VSAT network to ensure smooth switchover with zero downtime and no IP address change is required.</p>	<p><b>CORRIGENDUM:</b> i. Combination of any 2 different modes like Dual 4G / 5G SIM (Primary) with auto switch over between the 2 SIMs + VSAT (secondary) OR Broadband (primary) + Dual 4G / 5G SIM (Secondary) with auto switch over between the 2 SIMs OR any other combinations. Dual 4G / 5G SIM connectivity should be provided from two different services providers. <b>Dual 4G / 5G links should be on Active-Active with auto switchover to ensure seamless auto switchover amongst the two 4G /</b></p>

			different services providers.		5G links of the two separate Telcos / Service providers.
169	2.2 c) ii.	Offsite Endpoints	Wherever (i) is not feasible and only single mode option like only VSAT is available at a location, then combination of 2 different service providers like Hughes VSAT (primary) + Tata Nelco VSAT (secondary) etc. with auto switchover facility between the two VSATs shall be provided by Vendor.	who will be responsible for auto failover configuration and management, it should be with the front bidder or bank. Wherever (i) is not feasible and only single mode option like only VSAT is available at a location, then combination of 2 different VSATs operating on geographically separate Hubs with auto switchover to be provided by the vendor.	<b>CORRIGENDUM:</b> Wherever (i) is not feasible and only single mode option like only VSAT is available at a location, then <del>combination of 2 different service providers like Hughes VSAT (primary) + Tata Nelco VSAT (secondary) etc. with auto switchover facility between the two</del> <b>one VSAT in extended C Band shall be provided by Vendor.</b>



169	2.2 Offsite Endpoints:	c) i	<p>. Dual Mode connectivity means: -</p> <p>i. Combination of any 2 different modes like Dual 4G / 5G SIM (Primary) with auto switch over between the 2 SIMs + VSAT (secondary) OR Broadband (primary) + Dual 4G / 5G SIM (Secondary) with auto switch over between the 2 SIMs OR any other combinations. Dual 4G / 5G SIM connectivity should be provided from two different services providers.</p>	<p>Currently 5G SIM not supported requesting Bank to remove the 5G option.</p>	<p><b>CORRIGENDUM:</b></p> <p>i. Combination of any 2 different modes like Dual 4G / 5G SIM (Primary) with auto switch over between the 2 SIMs + VSAT (secondary) OR Broadband (primary) + Dual 4G / 5G SIM (Secondary) with auto switch over between the 2 SIMs OR any other combinations. Dual 4G / 5G SIM connectivity should be provided from two different services providers. <b>Dual 4G / 5G links should be on Active-Active with auto switchover to ensure seamless auto switchover amongst the two 4G / 5G links of the two separate Telcos / Service providers.</b></p>
-----	------------------------	------	---	--	--

169

2.2 Offsite  
Endpoints: c)  
i.

Combination of any 2 different modes like Dual 4G / 5G SIM (Primary) with auto switch over between the 2 SIMs + VSAT (secondary) OR Broadband (primary) + Dual 4G / 5G SIM (Secondary) with auto switch over between the 2 SIMs OR any other combinations. Dual 4G / 5G SIM connectivity should be provided from two different services providers.

Combination of any 2 different modes like Dual 4G / 5G SIM (Primary) with auto switch over between the 2 SIMs + VSAT (secondary) OR Broadband (primary) + Dual 4G / 5G SIM (Secondary) with auto switch over between the 2 SIMs OR any other combinations. Dual 4G / 5G SIM connectivity should be provided from two different services providers.

Dual 4G/5G links should be on Active-Active switchover to ensure quick switchover amongst the two 4G links of the two separate Telcos/Service providers.

**CORRIGENDUM:**

i. Combination of any 2 different modes like Dual 4G / 5G SIM (Primary) with auto switch over between the 2 SIMs + VSAT (secondary) OR Broadband (primary) + Dual 4G / 5G SIM (Secondary) with auto switch over between the 2 SIMs OR any other combinations. Dual 4G / 5G SIM connectivity should be provided from two different services providers. **Dual 4G / 5G links should be on Active-Active with auto switchover to ensure seamless auto switchover amongst the two 4G / 5G links of the two separate Telcos / Service providers.**

169	2.2 Offsite Endpoints: c) i.	Combination of any 2 different modes like Dual 4G / 5G SIM (Primary) with auto switch over between the 2 SIMs + VSAT (secondary) OR Broadband (primary) + Dual 4G / 5G SIM (Secondary) with auto switch over between the 2 SIMs OR any other combinations. Dual 4G / 5G SIM connectivity should be provided from two different services providers.	Combination of any 2 different modes like Dual 4G / 5G SIM (Primary) with auto switch over between the 2 SIMs + VSAT (secondary) OR Broadband (primary) + Dual 4G / 5G SIM (Secondary) with auto switch over between the 2 SIMs OR any other combinations. Dual 4G / 5G SIM connectivity should be provided from two different services providers.	As RBI guidelines, in case of the Broadband option there should not be local internet break out otherwise, it require high end SDWAN solution with NGFW, IPS, IDS solution.	<b>CORRIGENDUM:</b> i. Combination of any 2 different modes like Dual 4G / 5G SIM (Primary) with auto switch over between the 2 SIMs + VSAT (secondary) OR Broadband (primary) + Dual 4G / 5G SIM (Secondary) with auto switch over between the 2 SIMs OR any other combinations. Dual 4G / 5G SIM connectivity should be provided from two different services providers. <b>Dual 4G / 5G links should be on Active-Active with auto switchover to ensure seamless auto switchover amongst the two 4G / 5G links of the two separate Telcos / Service providers.</b>
-----	------------------------------	--	--	---	---

169	2.2 Offsite Endpoints: c) i.	Combination of any 2 different modes like Dual 4G / 5G SIM (Primary) with auto switch over between the 2 SIMs + VSAT (secondary) OR Broadband (primary) + Dual 4G / 5G SIM (Secondary) with auto switch over between the 2 SIMs OR any other combinations. Dual 4G / 5G SIM connectivity should be provided from two different services providers.	Combination of any 2 different modes like Dual 4G / 5G SIM (Primary) with auto switch over between the 2 SIMs + VSAT (secondary) OR Broadband (primary) + Dual 4G / 5G SIM (Secondary) with auto switch over between the 2 SIMs OR any other combinations. Dual 4G / 5G SIM connectivity should be provided from two different services providers.	Wherever existing site is being retained, the MSP should use the current VSAT network to ensure smooth switchover with zero downtime and no IP address change is required.	<b>CORRIGENDUM:</b> i. Combination of any 2 different modes like Dual 4G / 5G SIM (Primary) with auto switch over between the 2 SIMs + VSAT (secondary) OR Broadband (primary) + Dual 4G / 5G SIM (Secondary) with auto switch over between the 2 SIMs OR any other combinations. Dual 4G / 5G SIM connectivity should be provided from two different services providers. <b>Dual 4G / 5G links should be on Active-Active with auto switchover to ensure seamless auto switchover amongst the two 4G / 5G links of the two separate Telcos / Service providers.</b>
-----	------------------------------	--	--	--	---

169	2.2 Offsite Endpoints: c) i.	Combination of any 2 different modes like Dual 4G / 5G SIM (Primary) with auto switch over between the 2 SIMs + VSAT (secondary) OR Broadband (primary) + Dual 4G / 5G SIM (Secondary) with auto switch over between the 2 SIMs OR any other combinations. Dual 4G / 5G SIM connectivity should be provided from two different services providers.	Combination of any 2 different modes like Dual 4G / 5G SIM (Primary) with auto switch over between the 2 SIMs + VSAT (secondary) OR Broadband (primary) + Dual 4G / 5G SIM (Secondary) with auto switch over between the 2 SIMs OR any other combinations. Dual 4G / 5G SIM connectivity should be provided from two different services providers.	The primary Dual 4G link and the secondary VSAT link should be provided by the same service provider to ensure smooth switchover between the primary and secondary links and to ensure 100% ownership for the site uptime.	<b>CORRIGENDUM:</b> i. Combination of any 2 different modes like Dual 4G / 5G SIM (Primary) with auto switch over between the 2 SIMs + VSAT (secondary) OR Broadband (primary) + Dual 4G / 5G SIM (Secondary) with auto switch over between the 2 SIMs OR any other combinations. Dual 4G / 5G SIM connectivity should be provided from two different services providers. <b>Dual 4G / 5G links should be on Active-Active with auto switchover to ensure seamless auto switchover amongst the two 4G / 5G links of the two separate Telcos / Service providers.</b>
-----	------------------------------	--	--	--	---

169	2.2 Offsite Endpoints: c) i.		Combination of any 2 different modes like Dual 4G / 5G SIM (Primary) with auto switch over between the 2 SIMs + VSAT (secondary) OR Broadband (primary) + Dual 4G / 5G SIM (Secondary) with auto switch over between the 2 SIMs OR any other combinations. Dual 4G / 5G SIM connectivity should be provided from two different services providers.	Wherever existing site is being retained, the MSP should use the current VSAT network to ensure smooth switchover with zero downtime and no IP address change is required.	<b>CORRIGENDUM:</b> i. Combination of any 2 different modes like Dual 4G / 5G SIM (Primary) with auto switch over between the 2 SIMs + VSAT (secondary) OR Broadband (primary) + Dual 4G / 5G SIM (Secondary) with auto switch over between the 2 SIMs OR any other combinations. Dual 4G / 5G SIM connectivity should be provided from two different services providers. <b>Dual 4G / 5G links should be on Active-Active with auto switchover to ensure seamless auto switchover amongst the two 4G / 5G links of the two separate Telcos / Service providers.</b>
169	2.2 Offsite Endpoints: c) ii.		Wherever (i) is not feasible and only single mode option like only VSAT is available at a location, then combination of 2 different service providers like Hughes VSAT (primary) + Tata Nelco VSAT (secondary) etc. with auto switchover facility between the two VSATs shall be provided by Vendor.	who will be responsible for autofailover configuration and management, it should be with the front bidder or bank.	<b>CORRIGENDUM:</b> Wherever (i) is not feasible and only single mode option like only VSAT is available at a location, then <del>combination of 2 different service providers like Hughes VSAT (primary) + Tata Nelco VSAT (secondary) etc. with auto switchover facility between the two</del> <b>one VSAT in extended C Band shall be provided by Vendor.</b>

169	2.2 Offsite Endpoints: c) ii.	Wherever (i) is not feasible and only single mode option like only VSAT is available at a location, then combination of 2 different service providers like Hughes VSAT (primary) + Tata Nelco VSAT (secondary) etc. with auto switchover facility between the two VSATs shall be provided by Vendor.	Wherever (i) is not feasible and only single mode option like only VSAT is available at a location, then combination of 2 different VSATs operating on geographically separate Hubs with auto switchover to be provided by the vendor.	<b>CORRIGENDUM:</b> Wherever (i) is not feasible and only single mode option like only VSAT is available at a location, then <del>combination of 2 different service providers like Hughes VSAT (primary) + Tata Nelco VSAT (secondary) etc. with auto switchover facility between the two</del> <b>one VSAT in extended C Band shall be provided by Vendor.</b>
-----	-------------------------------	--	--	---

169	2.2 Offsite Endpoints-C-i	<p>Combination of any 2 different modes like Dual 4G / 5G SIM (Primary) with auto switch over between the 2 SIMs + VSAT (secondary) OR Broadband (primary) + Dual 4G / 5G SIM (Secondary) with auto switch over between the 2 SIMs OR any other combinations. Dual 4G / 5G SIM connectivity should be provided from two different services providers.</p>	<p>Combination of any 2 different modes like Dual 4G / 5G SIM (Primary) with auto switch over between the 2 SIMs + VSAT (secondary) OR Broadband (primary) + Dual 4G / 5G SIM (Secondary) with auto switch over between the 2 SIMs OR any other combinations. Dual 4G / 5G SIM connectivity should be provided from two different services providers.</p>	<p>In case of 4G the private APN solution is always prefer over open Internet SIM, for the reasons,</p> <ol style="list-style-type: none"> <li>1. As per DOT guidelines, the open Internet SIM can not be used for M2M connectivity (like ATM). The SIM should be private APN SIM.</li> <li>2. Security- In private APN the traffic moves in closed user group and not exposed to Internet</li> <li>3. In private APN traffic will handover using MPLS last mile redundant infra which gives better experience than Open Internet SIM which used public Internet cloud for traffic handover.</li> </ol> <p>Hence requesting bank to amend the requirement as , "  <i>Combination of any 2 different modes like Dual 4G / 5G SIM (Primary) with auto switch over between the 2 SIMs + VSAT (secondary) OR Broadband (primary) + Dual 4G / 5G SIM (Secondary) with auto switch over between the 2 SIMs OR any other combinations. Dual 4G / 5G SIM connectivity should be provided from two different services providers and</i></p>	<p>Terms &amp; Conditions applicable as per RFP. Further bidder has to comply Bank's IT security policy meticulously.</p>
-----	---------------------------	---	---	--	---



*should use private APN. The traffic from remote ATM should be delivered using backhaul infra between service provider HUB and Bank DC and DR."*

169	2.2 Offsite Endpoints-C-i	Networking connectivity	<p>Combination of any 2 different modes like Dual 4G / 5G SIM (Primary) with auto switch over between the 2 SIMs + VSAT (secondary) OR Broadband (primary) + Dual 4G / 5G SIM (Secondary) with auto switch over between the 2 SIMs OR any other combinations. Dual 4G / 5G SIM connectivity should be provided from two different services providers.</p>	<p>In case of 4G the private APN solution is always prefer over open Internet SIM, for the reasons,</p> <ol style="list-style-type: none"> <li>1. As per DOT guidelines, the open Internet SIM can not be used for M2M connectivity (like ATM). The SIM should be private APN SIM.</li> <li>2. Security- In private APN the traffic moves in closed user group and not exposed to Internet</li> <li>3. In private APN traffic will handover using MPLS last mile redundant infra which gives better experience than Open Internet SIM which used public Internet cloud for traffic handover.</li> </ol> <p>Hence requesting bank to amend the requirement as , "  <i>Combination of any 2 different modes like Dual 4G / 5G SIM (Primary) with auto switch over between the 2 SIMs + VSAT (secondary) OR Broadband (primary) + Dual 4G / 5G SIM (Secondary) with auto switch over between the 2 SIMs OR any other combinations. Dual 4G / 5G SIM connectivity should be provided from two different services providers and</i></p>	<p>Terms &amp; Conditions applicable as per RFP. . Further bidder has to comply Bank's IT security policy meticulously.</p>
-----	---------------------------	-------------------------	---	--	---

*should use private APN. The traffic from remote ATM should be delivered using backhaul infra between service provider HUB and Bank DC and DR."*

169	2.2 Offsite Endpoints-C-ii	Networking connectivity	<p>Wherever (i) is not feasible and only single mode option like only VSAT is available at a location, then combination of 2 different service providers like Hughes VSAT (primary) + Tata Nelco VSAT (secondary) etc. with auto switchover facility between the two VSATs shall be provided by Vendor</p>	<p>There will be a practical challenge in terms of space requirement/ roof Top permission for the dual VSAT installations at remote ATM. The Remote ATM roof-top/ground, in most cases do not have space for installation of two VSAT Terminals.</p> <p>Technically also there is a lot of challenge in fallback if the VSAT are from different service providers. As every service provider has different infra for VSAT connectivity and there is no scope mention in RFP, which service provider will configure and managed the fallback between two of the VSAT.</p> <p>The standalone VSAT is capable to provide 99.5% SLA. Hence requesting bank to remove the dual VSAT requirement and amend the clause as, "Wherever (i) is not feasible bidder can provision VSAT connectivity. "</p>	<p><b>CORRIGENDUM:</b> Wherever (i) is not feasible and only single mode option like only VSAT is available at a location, then <del>combination of 2 different service providers like Hughes VSAT (primary) + Tata Nelco VSAT (secondary) etc. with auto switchover facility between the two</del> <b>one VSAT in extended C Band shall be provided by Vendor.</b></p>
-----	----------------------------	-------------------------	--	---	---

169	2.2 Offsite Endpoints-C-ii	Wherever (i) is not feasible and only single mode option like only VSAT is available at a location, then combination of 2 different service providers like Hughes VSAT (primary) + Tata Nelco VSAT (secondary) etc. with auto switchover facility between the two VSATs shall be provided by Vendor	Wherever (i) is not feasible and only single mode option like only VSAT is available at a location, then combination of 2 different service providers like Hughes VSAT (primary) + Tata Nelco VSAT (secondary) etc. with auto switchover facility between the two VSATs shall be provided by Vendor	<p>There will be a practical challenge in terms of space requirement/ roof Top permission for the dual VSAT installations at remote ATM. The Remote ATM roof-top/ground, in most cases do not have space for installation of two VSAT Terminals.</p> <p>Technically also there is a lot of challenge in fallback if the VSAT are from different service providers. As every service provider has different infra for VSAT connectivity and there is no scope mention in RFP, which service provider will configure and manged the fallback between two of the VSAT.</p> <p>The standalone VSAT is capable to provide 99.5% SLA. Hence requesting bank to remove the dual VSAT requirement and amend the clause as, "Wherever (i) is not feasible bidder can provision VSAT connectivity. "</p>	<p><b>CORRIGENDUM:</b> Wherever (i) is not feasible and only single mode option like only VSAT is available at a location, then <del>combination of 2 different service providers like Hughes VSAT (primary) + Tata Nelco VSAT (secondary) etc. with auto switchover facility between the two</del> <b>one VSAT in extended C Band shall be provided by Vendor.</b></p>
-----	----------------------------	---	---	--	---

169	2.2 Offsite Endpoints-e	Networking connectivity	<p>The vendor should provide reliable and uninterrupted connectivity for ATMs.</p> <p>Using any of the last mile like leased line Fiber / Copper, RF, UBR, Dual 4G / 5G SIM {Dual 4G / 5G SIM connectivity should be provided from two different services providers}, VSAT or any upcoming newer technologies will also be acceptable subject to the clearance from Bank's Information Security Department (if not already done). Preference to Dual 4G / 5G SIM based connectivity or optical fiber may be given over VSAT. VSATs should be installed only at locations where Dual 4G / 5G SIM based connectivity is not available. Dual 4G</p>	<p>The point is contradict with the requirement mention in point no - 2.2 Offsite Endpoints-C-i page no 169 where bank has asked Dual 4G with VSAT / broadband. Hence requesting bank to amend the requirement as, "The vendor should provide reliable and uninterrupted connectivity for ATMs. Using any of the last mile like leased line Fiber / Copper, RF, UBR, Dual 4G / 5G SIM {Dual 4G / 5G SIM backup by VSAT as per the clause no 2.2 Offsite Endpoints-C-i."</p>	<p>Terms &amp; Conditions applicable as per RFP</p>
-----	-------------------------	-------------------------	--	---	---

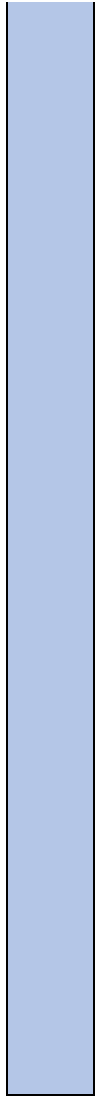

**/ 5G SIM based connectivity should be capable of providing multi-SIM connectivity which shall be delivered as per the Bank's requirement**

169	2.2 Offsite Endpoints-e	<p>The vendor should provide reliable and uninterrupted connectivity for ATMs. Using any of the last mile like leased line Fiber / Copper, RF, UBR, Dual 4G / 5G SIM {Dual 4G / 5G SIM connectivity should be provided from two different services providers}, VSAT or any upcoming newer technologies will also be acceptable subject to the clearance from Bank's Information Security Department (if not already done). Preference to Dual 4G / 5G SIM based connectivity or optical fibre may be given over VSAT. VSATs should be installed only at locations where Dual 4G / 5G SIM based connectivity is not available. Dual 4G / 5G SIM based connectivity should be capable of providing multi-SIM connectivity which shall be delivered as per the Bank's requirement</p>	<p>The vendor should provide reliable and uninterrupted connectivity for ATMs. Using any of the last mile like leased line Fiber / Copper, RF, UBR, Dual 4G / 5G SIM {Dual 4G / 5G SIM connectivity should be provided from two different services providers}, VSAT or any upcoming newer technologies will also be acceptable subject to the clearance from Bank's Information Security Department (if not already done). Preference to Dual 4G / 5G SIM based connectivity or optical fibre may be given over VSAT. VSATs should be installed only at locations where Dual 4G / 5G SIM based connectivity is not available. Dual 4G</p>	<p>The point is contradict with the requirement mention in point no - 2.2 Offsite Endpoints-C-i page no 169 where bank has asked Dual 4G with VSAT / broadband. Hence requesting bank to amend the requirement as, "The vendor should provide reliable and uninterrupted connectivity for ATMs. Using any of the last mile like leased line Fiber / Copper, RF, UBR, Dual 4G / 5G SIM {Dual 4G / 5G SIM backup by VSAT as per the clause no 2.2 Offsite Endpoints-C-i."</p>	<p>Terms &amp; Conditions applicable as per RFP</p>
-----	-------------------------	--	---	---	---



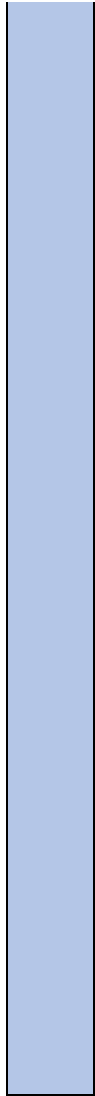

**/ 5G SIM based connectivity should be capable of providing multi-SIM connectivity which shall be delivered as per the Bank's requirement**

169	2.2 Offsite Endpoints-f	2.2 Offsite Endpoints-f	<p>The minimum bandwidth in case of VSAT last mile at each location for each ATM should be dedicated 64 Kbps with 100% concurrency (demand as on today) in extended C Band. Per ATM bandwidth requirement should match with the day-to-day requirement.</p>	<p>The KU band VSAT is capable to provide 99.5% uptime at remotest location. The Extended C band is recommended at the locations having high rain fall. Hence requesting bank to amend the clause as,          "The minimum bandwidth in case of VSAT last mile at each location for each ATM should be dedicated 64 Kbps with 100% concurrency (demand as on today) in combination of KU and extended c band.          minimum 5% VSAT should be installed in Extended C band. "</p>	<p><b>CORRIGENDUM:</b>  <del>The minimum bandwidth in case of VSAT last mile at each location for each ATM should be dedicated 64 Kbps with 100% concurrency (demand as on today) in extended C Band. Per ATM bandwidth requirement should match with the day to day requirement.</del> <b>Minimum bandwidth in case of VSAT last mile at each location for each ATM should be dedicated 32 Kbps for upload &amp; download respectively with 100% concurrency (demand as on today). Further, if two or more ATMs are connected with same VSAT then bandwidth would be 64 kbps using (Number of ATMs X Bandwidth) formula. However, this is applicable for VSAT connectivity only. The dedicated bandwidth should be adequately provided to carry out transactions smoothly.</b></p>
-----	-------------------------	-------------------------	---	---	---

169	2.2 Offsite Endpoints-f	The minimum bandwidth in case of VSAT last mile at each location for each ATM should be dedicated 64 Kbps with 100% concurrency (demand as on today) in extended C Band. Per ATM bandwidth requirement should match with the day-to-day requirement.	The minimum bandwidth in case of VSAT last mile at each location for each ATM should be dedicated 64 Kbps with 100% concurrency (demand as on today) in extended C Band. Per ATM bandwidth requirement should match with the day-to-day requirement.	It is understood that the BW is required as 32 Kbps up and 32 kbps Down . Please confirm	<p><b>CORRIGENDUM:</b>  <del>The minimum bandwidth in case of VSAT last mile at each location for each ATM should be dedicated 64 Kbps with 100% concurrency (demand as on today) in extended C Band. Per ATM bandwidth requirement should match with the day to day requirement.</del> <b>Minimum bandwidth in case of VSAT last mile at each location for each ATM should be dedicated 32 Kbps for upload &amp; download respectively with 100% concurrency (demand as on today). Further, if two or more ATMs are connected with same VSAT then bandwidth would be 64 kbps using (Number of ATMs X Bandwidth) formula. However, this is applicable for VSAT connectivity only. The dedicated bandwidth should be adequately provided to carry out transactions smoothly.</b></p>
-----	-------------------------	--	--	--	---

169

2.2 Offsite Endpoints-f

The minimum bandwidth in case of VSAT last mile at each location for each ATM should be dedicated 64 Kbps with 100% concurrency (demand as on today) in extended C Band. Per ATM bandwidth requirement should match with the day-to-day requirement.

The minimum bandwidth in case of VSAT last mile at each location for each ATM should be dedicated 64 Kbps with 100% concurrency (demand as on today) in extended C Band. Per ATM bandwidth requirement should match with the day-to-day requirement.

The KU band VSAT is capable to provide 99.5% uptime at remotest location. The Extended C band is recommended at the locations having high rain fall. Hence requesting bank to amend the clause as, "The minimum bandwidth in case of VSAT last mile at each location for each ATM should be dedicated 64 Kbps with 100% concurrency (demand as on today) in combination of KU and extended c band. minimum 5% VSAT should be installed in Extended C band. "

**CORRIGENDUM:**

~~The minimum bandwidth in case of VSAT last mile at each location for each ATM should be dedicated 64 Kbps with 100% concurrency (demand as on today) in extended C Band. Per ATM bandwidth requirement should match with the day to day requirement.~~ **Minimum bandwidth in case of VSAT last mile at each location for each ATM should be dedicated 32 Kbps for upload & download respectively with 100% concurrency (demand as on today). Further, if two or more ATMs are connected with same VSAT then bandwidth would be 64 kbps using (Number of ATMs X Bandwidth) formula. However, this is applicable for VSAT connectivity only. The dedicated bandwidth should be adequately provided to carry out transactions smoothly.**

169	2.2.i	Networking connectivity	<p>Combination of any 2 different modes like Dual 4G / 5G SIM (Primary) with auto switch over between the 2 SIMs + VSAT (secondary) OR Broadband (primary) + Dual 4G / 5G SIM (Secondary) with auto switch over between the 2 SIMs OR any other combinations. Dual 4G / 5G SIM connectivity should be provided from two different services providers.</p>	<p>We request bank to consider only one V-sat connectivity for all sites which is sufficient and SIM based connectivity for the site where V-sat is not feasible. Putting dual connectivity will not solve the problem because the weather affects all V-sat</p>	<p><b>CORRIGENDUM:</b>  i. Combination of any 2 different modes like Dual 4G / 5G SIM (Primary) with auto switch over between the 2 SIMs + VSAT (secondary) OR Broadband (primary) + Dual 4G / 5G SIM (Secondary) with auto switch over between the 2 SIMs OR any other combinations. Dual 4G / 5G SIM connectivity should be provided from two different services providers. <b>Dual 4G / 5G links should be on Active-Active with auto switchover to ensure seamless auto switchover amongst the two 4G / 5G links of the two separate Telcos / Service providers.</b></p>
-----	-------	-------------------------	---	--	--

170	2.2	2.2	Offsite Endpoints: e)	<p>The vendor should provide reliable and uninterrupted connectivity for ATMs. Using any of the last mile like leased line Fiber / Copper, RF, UBR, Dual 4G / 5G SIM {Dual 4G / 5G SIM connectivity should be provided from two different services providers}, VSAT or any upcoming newer technologies will also be acceptable subject to the clearance from Bank's Information Security Department (if not already done). Preference to Dual 4G / 5G SIM based connectivity or optical fibre may be given over VSAT. VSATs should be installed only at locations where Dual 4G / 5G SIM based connectivity is not available. Dual 4G / 5G SIM based connectivity should be capable of providing multi-SIM connectivity which shall be delivered as per the Bank's requirement.</p>	Terms & Conditions applicable as per RFP
-----	-----	-----	-----------------------	---	--

170	2.2	Offsite Endpoints: f)	The minimum bandwidth in case of VSAT last mile at each location for each ATM should be dedicated 64 Kbps with 100% concurrency (demand as on today) in extended C Band. Per ATM bandwidth requirement should match with the day-to-day requirement.	64 Kbps is combination of Upload and Download (32 +32) bandwidth or its 64 kbps Upload and 64 Kbps Download?	<p><b>CORRIGENDUM:</b>  <del>The minimum bandwidth in case of VSAT last mile at each location for each ATM should be dedicated 64 Kbps with 100% concurrency (demand as on today) in extended C Band. Per ATM bandwidth requirement should match with the day to day requirement.</del> <b>Minimum bandwidth in case of VSAT last mile at each location for each ATM should be dedicated 32 Kbps for upload &amp; download respectively with 100% concurrency (demand as on today). Further, if two or more ATMs are connected with same VSAT then bandwidth would be 64 kbps using (Number of ATMs X Bandwidth) formula. However, this is applicable for VSAT connectivity only. The dedicated bandwidth should be adequately provided to carry out transactions smoothly.</b></p>
-----	-----	-----------------------	--	--	---

170	2.2	Offsite Endpoints	<p>e) The vendor should provide reliable and uninterrupted connectivity for ATMs. Using any of the last mile like leased line Fiber / Copper, RF, UBR, Dual 4G / 5G SIM {Dual 4G / 5G SIM connectivity should be provided from two different services providers}, VSAT or any upcoming newer technologies will also be acceptable subject to the clearance from Bank's Information Security Department (if not already done). Preference to Dual 4G / 5G SIM based connectivity or optical fibre may be given over VSAT. VSATs should be installed only at locations where Dual 4G / 5G SIM based connectivity is not available. Dual 4G / 5G SIM based</p>	<p>The bidder requests the bank to clarify if 4G/5G connectivity is available and dual 4G/5G connectivity is provided, is it OK to not provide the VSAT or any other alternate connectivity as asked in the clause C1 of the same clause 2.2 in the RFP</p>	<p>Terms &amp; Conditions applicable as per RFP</p>
-----	-----	-------------------	---	---	---



		<p>connectivity should be capable of providing multi-SIM connectivity which shall be delivered as per the Bank's requirement.</p>		
--	--	---	--	--

170	2.2	Offsite Endpoints e	<p>The vendor should provide reliable and uninterrupted connectivity for ATMs. Using any of the last mile like leased line Fiber / Copper, RF, UBR, Dual 4G / 5G SIM {Dual 4G / 5G SIM connectivity should be provided from two different services providers}, VSAT or any upcoming newer technologies will also be acceptable subject to the clearance from Bank's Information Security Department (if not already done). Preference to Dual 4G / 5G SIM based connectivity or optical fibre may be given over VSAT. VSATs should be installed only at locations where Dual 4G / 5G SIM based connectivity is not available. Dual 4G / 5G SIM based connectivity should</p>	<p>The bidder recommends the bank to include " Private APN for 4G/5G connectivity, to ensure security and static IP addressing. Also, the 4G/5G SIMs should be without Voice, internet, SMS.</p>	<p>Terms &amp; Conditions applicable as per RFP. . Further bidder has to comply Bank's IT security policy meticulously.</p>
-----	-----	---------------------	--	--	---

		be capable of providing multi-SIM connectivity which shall be delivered as per the Bank's requirement.		
--	--	--	--	--

170	2.2	Offsite Endpoints f	<p>The minimum bandwidth in case of VSAT last mile at each location for each ATM should be dedicated 64 Kbps with 100% concurrency (demand as on today) in extended C Band.</p>	<p>Bidder requests the bank to have flexibility to choose the VSAT from Ex-C Band, Ku Band or Ka Band. for the following reasons. There are limited number of Ex-C band satellites provided by ISRO. Since network has to be maintained for 10 years, this should not become a limiting factor. 2. Moreover, Ex-C band VSATs cost twice the price of Ku Band VSATs. 3. Lastly, since Dual 4G is already a primary link the alternate Ku Band or Ka Band VSAT will meet Bank's uptime requirement at an optimal cost.</p>	<p><b>CORRIGENDUM:</b>  <del>The minimum bandwidth in case of VSAT last mile at each location for each ATM should be dedicated 64 Kbps with 100% concurrency (demand as on today) in extended C Band. Per ATM bandwidth requirement should match with the day to day requirement.</del> <b>Minimum bandwidth in case of VSAT last mile at each location for each ATM should be dedicated 32 Kbps for upload &amp; download respectively with 100% concurrency (demand as on today). Further, if two or more ATMs are connected with same VSAT then bandwidth would be 64 kbps using (Number of ATMs X Bandwidth) formula. However, this is applicable for VSAT connectivity only. The dedicated bandwidth should be adequately provided to carry out transactions smoothly.</b></p>
-----	-----	---------------------	---	--	---

170	2.2	Offsite Endpoints f	<p>The minimum bandwidth in case of VSAT last mile at each location for each ATM should be dedicated 64 Kbps with 100% concurrency (demand as on today) in extended C Band. Per ATM bandwidth requirement should match with the day-to-day requirement.</p>	<p>The bidder requests the bank to clarify if 64 Kbps is combination of Upload and Download (32 +32) bandwidth or its 64 kbps Upload and 64 Kbps Download?</p>	<p><b>CORRIGENDUM:</b>  <del>The minimum bandwidth in case of VSAT last mile at each location for each ATM should be dedicated 64 Kbps with 100% concurrency (demand as on today) in extended C Band. Per ATM bandwidth requirement should match with the day to day requirement.</del> <b>Minimum bandwidth in case of VSAT last mile at each location for each ATM should be dedicated 32 Kbps for upload &amp; download respectively with 100% concurrency (demand as on today). Further, if two or more ATMs are connected with same VSAT then bandwidth would be 64 kbps using (Number of ATMs X Bandwidth) formula. However, this is applicable for VSAT connectivity only. The dedicated bandwidth should be adequately provided to carry out transactions smoothly.</b></p>
-----	-----	---------------------	---	--	---

170	2.2	Offsite Endpoints f	The minimum bandwidth in case of VSAT last mile at each location for each ATM should be dedicated 64 Kbps with 100% concurrency (demand as on today) in extended C Band.	Bidder assumed that Bank wats 64Kbps for each ATM even for multiple ATMs that are deployed at site.	<p><b>CORRIGENDUM:</b>  <del>The minimum bandwidth in case of VSAT last mile at each location for each ATM should be dedicated 64 Kbps with 100% concurrency (demand as on today) in extended C Band. Per ATM bandwidth requirement should match with the day to day requirement.</del> Minimum bandwidth in case of VSAT last mile at each location for each ATM should be dedicated 32 Kbps for upload &amp; download respectively with 100% concurrency (demand as on today). Further, if two or more ATMs are connected with same VSAT then bandwidth would be 64 kbps using (Number of ATMs X Bandwidth) formula. However, this is applicable for VSAT connectivity only. The dedicated bandwidth should be adequately provided to carry out transactions smoothly.</p>
-----	-----	---------------------	--	---	--

170	2.2	Offsite Endpoints g	<p>Any software or application upgradation or network security requirements or application demands the bandwidth upgradation, the same should be made adequately available at no additional cost to the Bank to cater to the day-to-day requirement within the contract period. The same is applicable for other last mile also.</p>	<p>The bidder requests the bank to consider the BW higher than 64kbps as chargeable. To cater to any large size remote upgrades or future SW changes if any, BW of 128Kbps and 256 Kbps may be required. Request Bank to include the same</p>	<p>Terms &amp; Conditions applicable as per RFP</p>
-----	-----	---------------------	--	---	---

170	2.2	Offsite Endpoints: e)	<p>The vendor should provide reliable and uninterrupted connectivity for ATMs. Using any of the last mile like leased line Fiber / Copper, RF, UBR, Dual 4G / 5G SIM {Dual 4G / 5G SIM connectivity should be provided from two different services providers}, VSAT or any upcoming newer technologies will also be acceptable subject to the clearance from Bank's Information Security Department (if not already done). Preference to Dual 4G / 5G SIM based connectivity or optical fibre may be given over VSAT. VSATs should be installed only at locations where Dual 4G / 5G SIM based connectivity is not available. Dual 4G / 5G SIM based connectivity should</p>	<p>For the 4G/5G connectivity, it should be on Private APN to ensure security and static IP addressing. There will be no internet SIMs with local breakout as it will need high end SDWAN solution with NGFW, IPS, IDS solution. Also, the 4G/5G SIMs should be without Voice, internet, SMS.</p>	<p>Terms &amp; Conditions applicable as per RFP</p>
-----	-----	-----------------------	--	---	---



		be capable of providing multi-SIM connectivity which shall be delivered as per the Bank's requirement.		
--	--	--	--	--

170	2.2	Offsite Endpoints: f)	<p>The minimum bandwidth in case of VSAT last mile at each location for each ATM should be dedicated 64 Kbps with 100% concurrency (demand as on today) in extended C Band.</p>	<p>Bidders should have flexibility to choose the secondary VSAT from Ex-C Band, Ku Band or Ka Band. There are limited number of Ex-C band satellites provided by ISRO. Since network has to be maintained for 10 years, this should not become a limiting factor. Moreover, Ex-C band VSATs cost twice the price of Ku Band VSATs. Lastly, since Dual 4G is already provided as an alternative media at every ATM, Ku Band or Ka Band VSAT will meet Bank's uptime requirement at an optimal cost.</p>	<p><b>CORRIGENDUM:</b>  <del>The minimum bandwidth in case of VSAT last mile at each location for each ATM should be dedicated 64 Kbps with 100% concurrency (demand as on today) in extended C Band. Per ATM bandwidth requirement should match with the day to day requirement.</del> <b>Minimum bandwidth in case of VSAT last mile at each location for each ATM should be dedicated 32 Kbps for upload &amp; download respectively with 100% concurrency (demand as on today). Further, if two or more ATMs are connected with same VSAT then bandwidth would be 64 kbps using (Number of ATMs X Bandwidth) formula. However, this is applicable for VSAT connectivity only. The dedicated bandwidth should be adequately provided to carry out transactions smoothly.</b></p>
-----	-----	-----------------------	---	--	---

170	2.2	Offsite Endpoints: f)	The minimum bandwidth in case of VSAT last mile at each location for each ATM should be dedicated 64 Kbps with 100% concurrency (demand as on today) in extended C Band.	64Kbps for each ATM . In case multiple ATMs are deployed at site then the Bandwidth will be multiple of 64Kbps.	<p><b>CORRIGENDUM:</b>  <del>The minimum bandwidth in case of VSAT last mile at each location for each ATM should be dedicated 64 Kbps with 100% concurrency (demand as on today) in extended C Band. Per ATM bandwidth requirement should match with the day to day requirement.</del> Minimum bandwidth in case of VSAT last mile at each location for each ATM should be dedicated 32 Kbps for upload &amp; download respectively with 100% concurrency (demand as on today). Further, if two or more ATMs are connected with same VSAT then bandwidth would be 64 kbps using (Number of ATMs X Bandwidth) formula. However, this is applicable for VSAT connectivity only. The dedicated bandwidth should be adequately provided to carry out transactions smoothly.</p>
-----	-----	-----------------------	--	---	--

170	2.2	Offsite Endpoints: f)	<p>The minimum bandwidth in case of VSAT last mile at each location for each ATM should be dedicated 64 Kbps with 100% concurrency (demand as on today) in extended C Band.</p>	<p>Bidders should have flexibility to choose the secondary VSAT from Ex-C Band, Ku Band or Ka Band. There are limited number of Ex-C band satellites provided by ISRO. Since network has to be maintained for 10 years, this should not become a limiting factor. Moreover, Ex-C band VSATs cost twice the price of Ku Band VSATs. Lastly, since Dual 4G is already provided as an alternative media at every ATM, Ku Band or Ka Band VSAT will meet Bank's uptime requirement at an optimal cost.</p>	<p><b>CORRIGENDUM:</b>  <del>The minimum bandwidth in case of VSAT last mile at each location for each ATM should be dedicated 64 Kbps with 100% concurrency (demand as on today) in extended C Band. Per ATM bandwidth requirement should match with the day to day requirement.</del> <b>Minimum bandwidth in case of VSAT last mile at each location for each ATM should be dedicated 32 Kbps for upload &amp; download respectively with 100% concurrency (demand as on today). Further, if two or more ATMs are connected with same VSAT then bandwidth would be 64 kbps using (Number of ATMs X Bandwidth) formula. However, this is applicable for VSAT connectivity only. The dedicated bandwidth should be adequately provided to carry out transactions smoothly.</b></p>
-----	-----	-----------------------	---	--	---

170	2.2	Offsite Endpoints: f)	<p>The minimum bandwidth in case of VSAT last mile at each location for each ATM should be dedicated 64 Kbps with 100% concurrency (demand as on today) in extended C Band. Per ATM bandwidth requirement should match with the day-to-day requirement.</p>	<p>64 Kbps is combination of Upload and Download (32 +32) bandwidth or its 64 kbps Upload and 64 Kbps Download?</p>	<p><b>CORRIGENDUM:</b>  <del>The minimum bandwidth in case of VSAT last mile at each location for each ATM should be dedicated 64 Kbps with 100% concurrency (demand as on today) in extended C Band. Per ATM bandwidth requirement should match with the day to day requirement.</del> <b>Minimum bandwidth in case of VSAT last mile at each location for each ATM should be dedicated 32 Kbps for upload &amp; download respectively with 100% concurrency (demand as on today). Further, if two or more ATMs are connected with same VSAT then bandwidth would be 64 kbps using (Number of ATMs X Bandwidth) formula. However, this is applicable for VSAT connectivity only. The dedicated bandwidth should be adequately provided to carry out transactions smoothly.</b></p>
-----	-----	-----------------------	---	---	---

170	2.2	Offsite Endpoints: f)	The minimum bandwidth in case of VSAT last mile at each location for each ATM should be dedicated 64 Kbps with 100% concurrency (demand as on today) in extended C Band.	64Kbps for each ATM . In case multiple ATMs are deployed at site then the Bandwidth will be multiple of 64Kbps.	<p><b>CORRIGENDUM:</b>  <del>The minimum bandwidth in case of VSAT last mile at each location for each ATM should be dedicated 64 Kbps with 100% concurrency (demand as on today) in extended C Band. Per ATM bandwidth requirement should match with the day to day requirement.</del> <b>Minimum bandwidth in case of VSAT last mile at each location for each ATM should be dedicated 32 Kbps for upload &amp; download respectively with 100% concurrency (demand as on today). Further, if two or more ATMs are connected with same VSAT then bandwidth would be 64 kbps using (Number of ATMs X Bandwidth) formula. However, this is applicable for VSAT connectivity only. The dedicated bandwidth should be adequately provided to carry out transactions smoothly.</b></p>
-----	-----	-----------------------	--	---	---

170	2.2	Offsite Endpoints: g)	Any software or application upgradation or network security requirements or application demands the bandwidth upgradation, the same should be made adequately available at no additional cost to the Bank to cater to the day-to-day requirement within the contract period. The same is applicable for other last mile also.	The Contracted BW will be 64 Kbps per ATM. In case of extra bandwidth is required by bank for any purpose, that will be chargeable. Since Bank is looking for 7 year contract and during this period Bank may come up with new applications and security requirement which may demand higher Bandwidth per site. To cater this requirement it is required to discover the higher Bandwidth costs like 128Kbps and 256 Kbps. Request Bank to include the same	Terms & Conditions applicable as per RFP
170	2.2	Offsite Endpoints: g)	Any software or application upgradation or network security requirements or application demands the bandwidth upgradation, the same should be made adequately available at no additional cost to the Bank to cater to the day-to-day requirement within the contract period. The same is applicable	The Contracted BW will be 64 Kbps per ATM. In case of extra bandwidth is required by bank for any purpose, that will be chargeable. Since Bank is looking for 7 year contract and during this period Bank may come up with new applications and security requirement which may demand higher Bandwidth per site. To cater this requirement it is required to discover the higher Bandwidth costs like 128Kbps and 256 Kbps.	Terms & Conditions applicable as per RFP

			for other last mile also.	Request Bank to include the same	
170	2.2	Offsite Endpoints: h)	Bidder should also arrange for backhaul (from service providers BSNL, Bharti Airtel, Vodafone, TCL, Reliance JIO, Sify, Hughes, Tatanet, Railtel etc.), backhauls for connecting to the Bank's ATM Switch and DR.	Existing service providers may use the Backhaul links by upgrading the Bandwidth as needed.	Terms & Conditions applicable as per RFP
170	2.2	Offsite Endpoints: s)	If rack is required at DC / DR location the rack specification should match with SBI DC standard rack specifications.	We would recommend SBI to provide rack space for equipments, in case SBI cannot provide the same, please share the approved standard rack specifications.	Terms & Conditions applicable as per RFP



170	2.2	Offsite Endpoints-e	<p>The vendor should provide reliable and uninterrupted connectivity for ATMs.</p> <p>Using any of the last mile like leased line Fiber / Copper, RF, UBR, Dual 4G / 5G SIM {Dual 4G / 5G SIM connectivity should be provided from two different services providers}, VSAT or any upcoming newer technologies will also be acceptable subject to the clearance from Bank's Information Security Department (if not already done). Preference to Dual 4G / 5G SIM based connectivity or optical fibre may be given over VSAT. VSATs should be installed only at locations where Dual 4G / 5G SIM based connectivity is not available. Dual 4G</p>	<p>The point is contradict with the requirement mention in point no - 2.2 Offsite Endpoints-C-i page no 169 where bank has asked Dual 4G with VSAT / broadband. Hence requesting bank to amend the requirement as, "The vendor should provide reliable and uninterrupted connectivity for ATMs. Using any of the last mile like leased line Fiber / Copper, RF, UBR, Dual 4G / 5G SIM {Dual 4G / 5G SIM backup by VSAT as per the clause no 2.2 Offsite Endpoints-C-i."</p>	<p>Terms &amp; Conditions applicable as per RFP</p>
-----	-----	---------------------	--	---	---

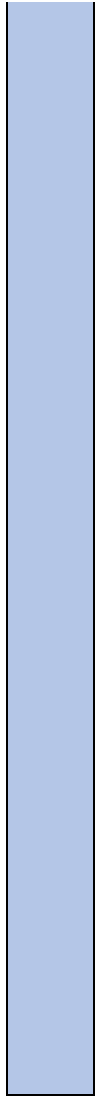

**/ 5G SIM based connectivity should be capable of providing multi-SIM connectivity which shall be delivered as per the Bank's requirement**

170	2.2	Offsite Endpointsh	Bidder should also arrange for backhaul (from service providers BSNL, Bharti Airtel, Vodafone, TCL, Reliance JIO, Sify, Hughes, Tatanet, Railtel etc.), backhauls for connecting to the Bank's ATM Switch and DR.	The bidder assumed that bank will have no objection allowing existing service providers to use the existin backhaul links by upgrading the Bandwidth as needed.	Terms & Conditions applicable as per RFP
170	2.2 ( c)-ii.	Appendix E - Scope of Work - Networking and Connectivity of ATMs	Wherever (i) is not feasible and only single mode option like only VSAT is available at a location, then combination of 2 different service providers like Hughes VSAT (primary) + Tata Nelco VSAT (secondary) etc. with auto switchover facility between the two VSATs shall be provided by Vendor.	As per Network Service Provider 1 - Please suggest, who will be responsible for auto failover configuration and its management, Bidder or Bank.  We also recommend that wherever c (i) option is not feasible and only single mode option like only VSAT is available at a location, then combination of 2 different VSATs operating on geographically separate Hubs, with auto switchover to be provided by the Vendor.	<b>CORRIGENDUM:</b> Wherever (i) is not feasible and only single mode option like only VSAT is available at a location, then <del>combination of 2 different service providers like Hughes VSAT (primary) + Tata Nelco VSAT (secondary) etc. with auto switchover facility between the two</del> <b>one VSAT in extended C Band shall be provided by Vendor.</b>

170	2.2 ( c)-ii.	Appendix E - Scope of Work - Networking and Connectivity of ATMs	Wherever (i) is not feasible and only single mode option like only VSAT is available at a location, then combination of 2 different service providers like Hughes VSAT (primary) + Tata Nelco VSAT (secondary) etc. with auto switchover facility between the two VSATs shall be provided by Vendor.	<p>As per Network Service Provider 2 - There will be a practical challenge in terms of space requirement/ roof Top permission for the dual VSAT installations at remote ATM. The Remote ATM roof-top/ground, in most cases do not have space for installation of two VSAT Terminals.</p> <p>Technically also there is a lot of challenge in fallback if the VSAT are from different service providers. As every service provider has different infra for VSAT connectivity and there is no scope mention in RFP, which service provider will configure and managed the fallback between two of the VSAT.</p> <p>The standalone VSAT is capable to provide 99.5% SLA. Hence requesting bank to remove the dual VSAT requirement and amend the clause as, "Wherever (i) is not feasible bidder can provision VSAT connectivity. "</p>	<p><b>CORRIGENDUM:</b> Wherever (i) is not feasible and only single mode option like only VSAT is available at a location, then <del>combination of 2 different service providers like Hughes VSAT (primary) + Tata Nelco VSAT (secondary) etc. with auto switchover facility between the two</del> <b>one VSAT in extended C Band shall be provided by Vendor.</b></p>
-----	--------------	--	--	---	---

170	2.2 e)	Offsite Endpoints	<p>The vendor should provide reliable and uninterrupted connectivity for ATMs. Using any of the last mile like leased line Fiber / Copper, RF, UBR, Dual 4G / 5G SIM {Dual 4G / 5G SIM connectivity should be provided from two different services providers}, VSAT or any upcoming newer technologies will also be acceptable subject to the clearance from Bank's Information Security Department (if not already done). Preference to Dual 4G / 5G SIM based connectivity or optical fibre may be given over VSAT. VSATs should be installed only at locations where Dual 4G / 5G SIM based connectivity is not available. Dual 4G / 5G SIM based connectivity should</p>	<p>For the 4G/5G connectivity, it should be on Private APN to ensure security and static IP addressing. There will be no internet SIMs with local breakout as it will need high end SDWAN solution with NGFW, IPS, IDS solution. Also, the 4G/5G SIMs should be without Voice, internet, SMS.</p>	<p>Terms &amp; Conditions applicable as per RFP. . Further bidder has to comply Bank's IT security policy meticulously.</p>
-----	--------	-------------------	--	---	---

		<p>be capable of providing multi-SIM connectivity which shall be delivered as per the Bank's requirement.</p>		
--	--	---	--	--

170	2.2 f)	Offsite Endpoints	<p>The minimum bandwidth in case of VSAT last mile at each location for each ATM should be dedicated 64 Kbps with 100% concurrency (demand as on today) in extended C Band.</p>	<p>Bidders should have flexibility to choose the secondary VSAT from Ex-C Band, Ku Band or Ka Band. There are limited number of Ex-C band satellites provided by ISRO. Since network has to be maintained for 10 years, this should not become a limiting factor. Moreover, Ex-C band VSATs cost twice the price of Ku Band VSATs. Lastly, since Dual 4G is already provided as an alternative media at every ATM, Ku Band or Ka Band VSAT will meet Bank's uptime requirement at an optimal cost.</p>	<p><b>CORRIGENDUM:</b>  <del>The minimum bandwidth in case of VSAT last mile at each location for each ATM should be dedicated 64 Kbps with 100% concurrency (demand as on today) in extended C Band. Per ATM bandwidth requirement should match with the day to day requirement.</del> <b>Minimum bandwidth in case of VSAT last mile at each location for each ATM should be dedicated 32 Kbps for upload &amp; download respectively with 100% concurrency (demand as on today). Further, if two or more ATMs are connected with same VSAT then bandwidth would be 64 kbps using (Number of ATMs X Bandwidth) formula. However, this is applicable for VSAT connectivity only. The dedicated bandwidth should be adequately provided to carry out transactions smoothly.</b></p>
-----	--------	-------------------	---	--	---

170	2.2 f)	Offsite Endpoints	<p>The minimum bandwidth in case of VSAT last mile at each location for each ATM should be dedicated 64 Kbps with 100% concurrency (demand as on today) in extended C Band. Per ATM bandwidth requirement should match with the day-to-day requirement.</p>	<p>64 Kbps is combination of Upload and Download (32 +32) bandwidth or its 64 kbps Upload and 64 Kbps Download? Incase multiple ATMs are deployed at site then the Bandwidth will be multiple of 64Kbps.</p>	<p><b>CORRIGENDUM:</b>  <del>The minimum bandwidth in case of VSAT last mile at each location for each ATM should be dedicated 64 Kbps with 100% concurrency (demand as on today) in extended C Band. Per ATM bandwidth requirement should match with the day to day requirement.</del> <b>Minimum bandwidth in case of VSAT last mile at each location for each ATM should be dedicated 32 Kbps for upload &amp; download respectively with 100% concurrency (demand as on today). Further, if two or more ATMs are connected with same VSAT then bandwidth would be 64 kbps using (Number of ATMs X Bandwidth) formula. However, this is applicable for VSAT connectivity only. The dedicated bandwidth should be adequately provided to carry out transactions smoothly.</b></p>
-----	--------	-------------------	---	--	---



170	2.2 g)	Offsite Endpoints	Any software or application upgradation or network security requirements or application demands the bandwidth upgradation, the same should be made adequately available at no additional cost to the Bank to cater to the day-to-day requirement within the contract period. The same is applicable for other last mile also.	The Contracted BW will be 64 Kbps per ATM. In case of extra bandwidth is required by bank for any purpose, that will be chargeable. Since Bank is looking for 7 year contract and during this period Bank may come up with new applications and security requirement which may demand higher Bandwidth per site. To cater this requirement it is required to discover the higher Bandwidth costs like 128Kbps and 256 Kbps. Request Bank to include the same	Terms & Conditions applicable as per RFP. Further bidder has to comply Bank's IT security policy meticulously.
170	2.2 h)	Offsite Endpoints	Bidder should also arrange for backhaul (from service providers BSNL, Bharti Airtel, Vodafone, TCL, Reliance JIO, Sify, Hughes, Tatanet, Railtel etc.), backhails for connecting to the Bank's ATM Switch and DR.	Existing service providers may use the Backhaul links by upgrading the Bandwidth as needed.	Terms & Conditions applicable as per RFP. Further bidder has to comply Bank's IT security policy meticulously.

170	2.2 Offsite Endpoints: e)	2.2 Offsite Endpoints: e)	<p>The vendor should provide reliable and uninterrupted connectivity for ATMs. Using any of the last mile like leased line Fiber / Copper, RF, UBR, Dual 4G / 5G SIM {Dual 4G / 5G SIM connectivity should be provided from two different services providers}, VSAT or any upcoming newer technologies will also be acceptable subject to the clearance from Bank's Information Security Department (if not already done). Preference to Dual 4G / 5G SIM based connectivity or optical fibre may be given over VSAT. VSATs should be installed only at locations where Dual 4G / 5G SIM based connectivity is not available. Dual 4G / 5G SIM based connectivity should</p>	<p>For the 4G/5G connectivity, it should be on Private APN to ensure security and static IP addressing. There will be no internet SIMs with local breakout as it will need high end SDWAN solution with NGFW, IPS, IDS solution. Also, the 4G/5G SIMs should be without Voice, internet, SMS.</p>	<p>Terms &amp; Conditions applicable as per RFP. . Further bidder has to comply Bank's IT security policy meticulously.</p>
-----	---------------------------	---------------------------	--	---	---

		<p>be capable of providing multi-SIM connectivity which shall be delivered as per the Bank's requirement.</p>		
--	--	---	--	--

170

2.2 Offsite  
Endpoints: e)

The vendor should provide reliable and uninterrupted connectivity for ATMs. Using any of the last mile like leased line Fiber / Copper, RF, UBR, Dual 4G / 5G SIM {Dual 4G / 5G SIM connectivity should be provided from two different services providers}, VSAT or any upcoming newer technologies will also be acceptable subject to the clearance from Bank's Information Security Department (if not already done). Preference to Dual 4G / 5G SIM based connectivity or optical fibre may be given over VSAT. VSATs should be installed only at locations where Dual 4G / 5G SIM based connectivity is not available. Dual 4G / 5G SIM based connectivity should be capable of providing multi-SIM connectivity which shall be delivered as per the Bank's requirement.

The vendor should provide reliable and uninterrupted connectivity for ATMs. Using any of the last mile like leased line Fiber / Copper, RF, UBR, Dual 4G / 5G SIM {Dual 4G / 5G SIM connectivity should be provided from two different services providers}, VSAT or any upcoming newer technologies will also be acceptable subject to the clearance from Bank's Information Security Department (if not already done). Preference to Dual 4G / 5G SIM based connectivity or optical fibre may be given over VSAT. VSATs should be installed only at locations where Dual 4G / 5G SIM based connectivity is not available. Dual 4G / 5G SIM based connectivity should

For the 4G/5G connectivity, it should be on Private APN to ensure security and static IP addressing. There will be no internet SIMs with local breakout as it will need high end SDWAN solution with NGFW, IPS, IDS solution. Also, the 4G/5G SIMs should be without Voice, internet, SMS.

Terms & Conditions applicable as per RFP. . Further bidder has to comply Bank's IT security policy meticulously.

		<p>be capable of providing multi-SIM connectivity which shall be delivered as per the Bank's requirement.</p>		
--	--	---	--	--

170	2.2 Offsite Endpoints: f)	2.2 Offsite Endpoints: f)	<p>The minimum bandwidth in case of VSAT last mile at each location for each ATM should be dedicated 64 Kbps with 100% concurrency (demand as on today) in extended C Band.</p>	<p>Bidders should have flexibility to choose the secondary VSAT from Ex-C Band, Ku Band or Ka Band. There are limited number of Ex-C band satellites provided by ISRO. Since network has to be maintained for 10 years, this should not become a limiting factor. Moreover, Ex-C band VSATs cost twice the price of Ku Band VSATs. Lastly, since Dual 4G is already provided as an alternative media at every ATM, Ku Band or Ka Band VSAT will meet Bank's uptime requirement at an optimal cost.</p>	<p><b>CORRIGENDUM:</b>  <del>The minimum bandwidth in case of VSAT last mile at each location for each ATM should be dedicated 64 Kbps with 100% concurrency (demand as on today) in extended C Band. Per ATM bandwidth requirement should match with the day to day requirement.</del> <b>Minimum bandwidth in case of VSAT last mile at each location for each ATM should be dedicated 32 Kbps for upload &amp; download respectively with 100% concurrency (demand as on today). Further, if two or more ATMs are connected with same VSAT then bandwidth would be 64 kbps using (Number of ATMs X Bandwidth) formula. However, this is applicable for VSAT connectivity only. The dedicated bandwidth should be adequately provided to carry out transactions smoothly.</b></p>
-----	---------------------------	---------------------------	---	--	---

170	2.2 Offsite Endpoints: f)	2.2 Offsite Endpoints: f)	The minimum bandwidth in case of VSAT last mile at each location for each ATM should be dedicated 64 Kbps with 100% concurrency (demand as on today) in extended C Band. Per ATM bandwidth requirement should match with the day-to-day requirement.	64 Kbps is combination of Upload and Download (32 +32) bandwidth or its 64 kbps Upload and 64 Kbps Download?	<p><b>CORRIGENDUM:</b>  <del>The minimum bandwidth in case of VSAT last mile at each location for each ATM should be dedicated 64 Kbps with 100% concurrency (demand as on today) in extended C Band. Per ATM bandwidth requirement should match with the day to day requirement.</del> <b>Minimum bandwidth in case of VSAT last mile at each location for each ATM should be dedicated 32 Kbps for upload &amp; download respectively with 100% concurrency (demand as on today). Further, if two or more ATMs are connected with same VSAT then bandwidth would be 64 kbps using (Number of ATMs X Bandwidth) formula. However, this is applicable for VSAT connectivity only. The dedicated bandwidth should be adequately provided to carry out transactions smoothly.</b></p>
-----	---------------------------	---------------------------	--	--	---

170	2.2 Offsite Endpoints: f)	2.2 Offsite Endpoints: f)	The minimum bandwidth in case of VSAT last mile at each location for each ATM should be dedicated 64 Kbps with 100% concurrency (demand as on today) in extended C Band.	64Kbps for each ATM . In case multiple ATMs are deployed at site then the Bandwidth will be multiple of 64Kbps.	<p><b>CORRIGENDUM:</b>  <del>The minimum bandwidth in case of VSAT last mile at each location for each ATM should be dedicated 64 Kbps with 100% concurrency (demand as on today) in extended C Band. Per ATM bandwidth requirement should match with the day to day requirement.</del> <b>Minimum bandwidth in case of VSAT last mile at each location for each ATM should be dedicated 32 Kbps for upload &amp; download respectively with 100% concurrency (demand as on today). Further, if two or more ATMs are connected with same VSAT then bandwidth would be 64 kbps using (Number of ATMs X Bandwidth) formula. However, this is applicable for VSAT connectivity only. The dedicated bandwidth should be adequately provided to carry out transactions smoothly.</b></p>
-----	---------------------------	---------------------------	--	---	---



170	2.2 Offsite Endpoints: f)	The minimum bandwidth in case of VSAT last mile at each location for each ATM should be dedicated 64 Kbps with 100% concurrency (demand as on today) in extended C Band.	The minimum bandwidth in case of VSAT last mile at each location for each ATM should be dedicated 64 Kbps with 100% concurrency (demand as on today) in extended C Band.	Bidders should have flexibility to choose the secondary VSAT from Ex-C Band, Ku Band or Ka Band. There are limited number of Ex-C band satellites provided by ISRO. Since network has to be maintained for 10 years, this should not become a limiting factor. Moreover, Ex-C band VSATs cost twice the price of Ku Band VSATs. Lastly, since Dual 4G is already provided as an alternative media at every ATM, Ku Band or Ka Band VSAT will meet Bank's uptime requirement at an optimal cost.	<p><b>CORRIGENDUM:</b>  <del>The minimum bandwidth in case of VSAT last mile at each location for each ATM should be dedicated 64 Kbps with 100% concurrency (demand as on today) in extended C Band. Per ATM bandwidth requirement should match with the day to day requirement.</del> <b>Minimum bandwidth in case of VSAT last mile at each location for each ATM should be dedicated 32 Kbps for upload &amp; download respectively with 100% concurrency (demand as on today). Further, if two or more ATMs are connected with same VSAT then bandwidth would be 64 kbps using (Number of ATMs X Bandwidth) formula. However, this is applicable for VSAT connectivity only. The dedicated bandwidth should be adequately provided to carry out transactions smoothly.</b></p>
-----	---------------------------	--	--	---	---

170	2.2 Offsite Endpoints: f)	The minimum bandwidth in case of VSAT last mile at each location for each ATM should be dedicated 64 Kbps with 100% concurrency (demand as on today) in extended C Band. Per ATM bandwidth requirement should match with the day-to-day requirement.	The minimum bandwidth in case of VSAT last mile at each location for each ATM should be dedicated 64 Kbps with 100% concurrency (demand as on today) in extended C Band. Per ATM bandwidth requirement should match with the day-to-day requirement.	Requesting Bank to recheck the dedicated 64Kbps Bandwidth as in current operation it's need to revised.	<p><b>CORRIGENDUM:</b>  <del>The minimum bandwidth in case of VSAT last mile at each location for each ATM should be dedicated 64 Kbps with 100% concurrency (demand as on today) in extended C Band. Per ATM bandwidth requirement should match with the day to day requirement.</del> <b>Minimum bandwidth in case of VSAT last mile at each location for each ATM should be dedicated 32 Kbps for upload &amp; download respectively with 100% concurrency (demand as on today). Further, if two or more ATMs are connected with same VSAT then bandwidth would be 64 kbps using (Number of ATMs X Bandwidth) formula. However, this is applicable for VSAT connectivity only. The dedicated bandwidth should be adequately provided to carry out transactions smoothly.</b></p>
-----	---------------------------	--	--	---	---

170	2.2 Offsite Endpoints: f)		<p>The minimum bandwidth in case of VSAT last mile at each location for each ATM should be dedicated 64 Kbps with 100% concurrency (demand as on today) in extended C Band.</p>	<p>Bidders should have flexibility to choose the secondary VSAT from Ex-C Band, Ku Band or Ka Band. There are limited number of Ex-C band satellites provided by ISRO. Since network has to be maintained for 10 years, this should not become a limiting factor. Moreover, Ex-C band VSATs cost twice the price of Ku Band VSATs. Lastly, since Dual 4G is already provided as an alternative media at every ATM, Ku Band or Ka Band VSAT will meet Bank's uptime requirement at an optimal cost.</p>	<p><b>CORRIGENDUM:</b>  <del>The minimum bandwidth in case of VSAT last mile at each location for each ATM should be dedicated 64 Kbps with 100% concurrency (demand as on today) in extended C Band. Per ATM bandwidth requirement should match with the day to day requirement.</del> <b>Minimum bandwidth in case of VSAT last mile at each location for each ATM should be dedicated 32 Kbps for upload &amp; download respectively with 100% concurrency (demand as on today). Further, if two or more ATMs are connected with same VSAT then bandwidth would be 64 kbps using (Number of ATMs X Bandwidth) formula. However, this is applicable for VSAT connectivity only. The dedicated bandwidth should be adequately provided to carry out transactions smoothly.</b></p>
-----	---------------------------	--	---	--	---

170	2.2 Offsite Endpoints: f)		<p>The minimum bandwidth in case of VSAT last mile at each location for each ATM should be dedicated 64 Kbps with 100% concurrency (demand as on today) in extended C Band. Per ATM bandwidth requirement should match with the day-to-day requirement.</p>	<p>64 Kbps is combination of Upload and Download (32 +32) bandwidth or its 64 kbps Upload and 64 Kbps Download?</p>	<p><b>CORRIGENDUM:</b>  <del>The minimum bandwidth in case of VSAT last mile at each location for each ATM should be dedicated 64 Kbps with 100% concurrency (demand as on today) in extended C Band. Per ATM bandwidth requirement should match with the day to day requirement.</del> <b>Minimum bandwidth in case of VSAT last mile at each location for each ATM should be dedicated 32 Kbps for upload &amp; download respectively with 100% concurrency (demand as on today). Further, if two or more ATMs are connected with same VSAT then bandwidth would be 64 kbps using (Number of ATMs X Bandwidth) formula. However, this is applicable for VSAT connectivity only. The dedicated bandwidth should be adequately provided to carry out transactions smoothly.</b></p>
-----	---------------------------	--	---	---	---

170	2.2 Offsite Endpoints: g)	2.2 Offsite Endpoints: g)	Any software or application upgradation or network security requirements or application demands the bandwidth upgradation, the same should be made adequately available at no additional cost to the Bank to cater to the day-to-day requirement within the contract period. The same is applicable for other last mile also.	The Contracted BW will be 64 Kbps per ATM. In case of extra bandwidth is required by bank for any purpose, that will be chargeable. Since Bank is looking for 7 year contract and during this period Bank may come up with new applications and security requirement which may demand higher Bandwidth per site. To cater this requirement it is required to discover the higher Bandwidth costs like 128Kbps and 256 Kbps. Request Bank to include the same	Terms & Conditions applicable as per RFP. Further bidder has to comply Bank's IT security policy meticulously.
-----	---------------------------	---------------------------	---	--	--

170	2.2 Offsite Endpoints: g)	Any software or application upgradation or network security requirements or application demands the bandwidth upgradation, the same should be made adequately available at no additional cost to the Bank to cater to the day-to-day requirement within the contract period. The same is applicable for other last mile also.	Any software or application upgradation or network security requirements or application demands the bandwidth upgradation, the same should be made adequately available at no additional cost to the Bank to cater to the day-to-day requirement within the contract period. The same is applicable for other last mile also.	The Contracted BW will be 64 Kbps per ATM. In case of extra bandwidth is required by bank for any purpose, that will be chargeable. Since Bank is looking for 7 year contract and during this period Bank may come up with new applications and security requirement which may demand higher Bandwidth per site. To cater this requirement it is required to discover the higher Bandwidth costs like 128Kbps and 256 Kbps. Request Bank to include the same	Terms & Conditions applicable as per RFP. Clarification: bidder has to comply Bank's IT security policy meticulously.
-----	---------------------------	---	---	--	---

170	2.2 Offsite Endpoints: g)		Any software or application upgradation or network security requirements or application demands the bandwidth upgradation, the same should be made adequately available at no additional cost to the Bank to cater to the day-to-day requirement within the contract period. The same is applicable for other last mile also.	The Contracted BW will be 64 Kbps per ATM. In case of extra bandwidth is required by bank for any purpose, that will be chargeable. Since Bank is looking for 7 year contract and during this period Bank may come up with new applications and security requirement which may demand higher Bandwidth per site. To cater this requirement it is required to discover the higher Bandwidth costs like 128Kbps and 256 Kbps. Request Bank to include the same	Terms & Conditions applicable as per RFP. Clarification: bidder has to comply Bank's IT security policy meticulously.
170	2.2 Offsite Endpoints: h)	2.2 Offsite Endpoints: h)	Bidder should also arrange for backhaul (from service providers BSNL, Bharti Airtel, Vodafone, TCL, Reliance JIO, Sify, Hughes, Tatanet, Railtel etc.), backhails for connecting to the Bank's ATM Switch and DR.	Existing service providers may use the Backhaul links by upgrading the Bandwidth as needed.	Terms & Conditions applicable as per RFP. Clarification: bidder has to comply Bank's IT security policy meticulously.

170	2.2 Offsite Endpoints: h)	Bidder should also arrange for backhaul (from service providers BSNL, Bharti Airtel, Vodafone, TCL, Reliance JIO, Sify, Hughes, Tatanet, Railtel etc.), backhauls for connecting to the Bank's ATM Switch and DR.	Bidder should also arrange for backhaul (from service providers BSNL, Bharti Airtel, Vodafone, TCL, Reliance JIO, Sify, Hughes, Tatanet, Railtel etc.), backhauls for connecting to the Bank's ATM Switch and DR.	Existing service providers may use the Backhaul links by upgrading the Bandwidth as needed.	Terms & Conditions applicable as per RFP. Clarification: bidder has to comply Bank's IT security policy meticulously.
170	2.2 Offsite Endpoints: h)		Bidder should also arrange for backhaul (from service providers BSNL, Bharti Airtel, Vodafone, TCL, Reliance JIO, Sify, Hughes, Tatanet, Railtel etc.), backhauls for connecting to the Bank's ATM Switch and DR.	Existing service providers may use the Backhaul links by upgrading the Bandwidth as needed.	Terms & Conditions applicable as per RFP. Clarification: bidder has to comply Bank's IT security policy meticulously.



170	2.2(e)	Appendix E - Scope of Work - Networking and Connectivity of ATMs	<p>The vendor should provide reliable and uninterrupted connectivity for ATMs. Using any of the last mile like leased line Fiber / Copper, RF, UBR, Dual 4G / 5G SIM {Dual 4G / 5G SIM connectivity should be provided from two different services providers}, VSAT or any upcoming newer technologies will also be acceptable subject to the clearance from Bank's Information Security Department (if not already done). Preference to Dual 4G / 5G SIM based connectivity or optical fiber may be given over VSAT. VSATs should be installed only at locations where Dual 4G / 5G SIM based connectivity is not available. Dual 4G / 5G SIM based connectivity should</p>	<p>As per Network Service Provider 1 - For the 4G/5G connectivity, it should be on Private APN to ensure security and static IP addressing. There will be no internet SIMs with local breakout as it will need high end SDWAN solution with NGFW, IPS, IDS solution. Also, the 4G/5G SIMs should be without Voice, internet, SMS. Please clarify the same.</p>	<p>Terms &amp; Conditions applicable as per RFP. Clarification: bidder has to comply Bank's IT security policy meticulously.</p>
-----	--------	--	--	--	--

		<p>be capable of providing multi-SIM connectivity which shall be delivered as per the Bank's requirement.</p>		
--	--	---	--	--

170	2.2(e)	Appendix E - Scope of Work - Networking and Connectivity of ATMs	<p>The vendor should provide reliable and uninterrupted connectivity for ATMs. Using any of the last mile like leased line Fiber / Copper, RF, UBR, Dual 4G / 5G SIM {Dual 4G / 5G SIM connectivity from two different services providers}, VSAT or any upcoming newer technologies will also be acceptable subject to the clearance from Bank's Information Security Department (if not already done). Preference to Dual 4G / 5G SIM based connectivity or optical fiber may be given over VSAT. VSATs should be installed only at locations where Dual 4G / 5G SIM based connectivity is not available. Dual 4G / 5G SIM based connectivity should</p>	<p>As per Network Service Provider 2 - The point is contradict with the requirement mention in point no - 2.2 Offsite Endpoints-C-i page no 169 where bank has asked Dual 4G with VSAT / broadband. Hence requesting bank to amend the requirement as, "The vendor should provide reliable and uninterrupted connectivity for ATMs. Using any of the last mile like leased line Fiber / Copper, RF, UBR, Dual 4G / 5G SIM {Dual 4G / 5G SIM backup by VSAT as per the clause no 2.2 Offsite Endpoints-C-i."</p>	<p>Terms &amp; Conditions applicable as per RFP</p>
-----	--------	--	---	---	---

		<p>be capable of providing multi-SIM connectivity which shall be delivered as per the Bank's requirement.</p>		
--	--	---	--	--

170	2.2(f)	Appendix E - Scope of Work- - Networking and Connectivity of ATMs	<p>The minimum bandwidth in case of VSAT last mile at each location for each ATM should be dedicated 64 Kbps with 100% concurrency (demand as on today) in extended C Band. Per ATM bandwidth requirement should match with the day-to-day requirement.</p>	<p>As per Network Service Provider 1 - We request the Bank to have flexibility for choosing the secondary VSAT from Ex-C Band, Ku Band or Ka Band.</p> <p>There are limited number of Ex-C band satellites provided by ISRO.</p> <p>Since, the network has to be maintained for 10 years, this should not become a limiting factor.</p> <p>Also, Ex-C band VSATs cost twice the price of Ku Band VSATs and Dual 4G is already provided as an alternative media at every ATM, Ku Band or Ka Band VSAT will meet the Bank's uptime requirement at an optimal cost, which in turn can help the bidder to quote the better pricing.</p> <p>Whether 64 Kbps is a combination of Upload and Download (32 +32) bandwidth or its 64 kbps Upload and 64 Kbps Download, please clarify.</p> <p>Also clarify that 64Kbps bandwidth is required for each ATM and What will be the</p>	<p><b>CORRIGENDUM:</b></p> <p><del>The minimum bandwidth in case of VSAT last mile at each location for each ATM should be dedicated 64 Kbps with 100% concurrency (demand as on today) in extended C Band. Per ATM bandwidth requirement should match with the day to day requirement.</del> <b>Minimum bandwidth in case of VSAT last mile at each location for each ATM should be dedicated 32 Kbps for upload &amp; download respectively with 100% concurrency (demand as on today). Further, if two or more ATMs are connected with same VSAT then bandwidth would be 64 kbps using (Number of ATMs X Bandwidth) formula. However, this is applicable for VSAT connectivity only. The dedicated bandwidth should be adequately provided to carry out transactions smoothly.</b></p>
-----	--------	---	---	---	---

			expectation for the sites having multiple ATMs.	
--	--	--	---	--

170	2.2(f)	Appendix E - Scope of Work- - Networking and Connectivity of ATMs	The minimum bandwidth in case of VSAT last mile at each location for each ATM should be dedicated 64 Kbps with 100% concurrency (demand as on today) in extended C Band. Per ATM bandwidth requirement should match with the day-to-day requirement.	<p>As per Network Service Provider 2 - It is understood that the Bandwidth is required as 32 Kbps up and 32 kbps Down . Please confirm</p> <p>Also the KU band VSAT is capable to provide 99.5% uptime at remotest location. The Extended C band is recommended at the locations having high rain fall. Hence requesting bank to amend the clause as,          "The minimum bandwidth in case of VSAT last mile at each location for each ATM should be dedicated 64 Kbps with 100% concurrency (demand as on today) in combination of KU and extended c band. minimum 5% VSAT should be installed in Extended C band. "</p>	<p><b>CORRIGENDUM:</b>  <del>The minimum bandwidth in case of VSAT last mile at each location for each ATM should be dedicated 64 Kbps with 100% concurrency (demand as on today) in extended C Band. Per ATM bandwidth requirement should match with the day to day requirement.</del> <b>Minimum bandwidth in case of VSAT last mile at each location for each ATM should be dedicated 32 Kbps for upload &amp; download respectively with 100% concurrency (demand as on today). Further, if two or more ATMs are connected with same VSAT then bandwidth would be 64 kbps using (Number of ATMs X Bandwidth) formula. However, this is applicable for VSAT connectivity only. The dedicated bandwidth should be adequately provided to carry out transactions smoothly.</b></p>
-----	--------	---	--	--	---

170	2.2(g)	Appendix E - Scope of Work- - Networking and Connectivity of ATMs	Any software or application upgradation or network security requirements or application demands the bandwidth upgradation, the same should be made adequately available at no additional cost to the Bank to cater to the day-to-day requirement within the contract period. The same is applicable for other last mile also.	<p>As per Network Service Provider 1 - Bandwidth will be 64 Kbps per ATM as per requirement of this project. However, in case of extra bandwidth requirement by the Bank for any purpose, then it will be on chargeable basis on mutual agreed terms.</p> <p>Since Bank is looking for 7 year contract and during this period Bank may come up with new applications and security requirement which may demand higher Bandwidth per site. To cater this requirement it is required to discover the higher Bandwidth costs like 128Kbps and 256 Kbps.</p> <p>We request Bank to include the same.</p>	Terms & Conditions applicable as per RFP
170	2.2(h)	Appendix E - Scope of Work- - Networking and Connectivity of ATMs	Bidder should also arrange for backhaul (from service providers BSNL, Bharti Airtel, Vodafone, TCL, Reliance JIO, Sify, Hughes, Tatanet, Railtel etc.), backhauls for connecting to the	As per Network Service Provider 1 - We request the Bank for allowing the existing network service providers to use the Backhaul links by upgrading the Bandwidth as needed.	Terms & Conditions applicable as per RFP



			Bank's ATM Switch and DR.		
170	2.2.f	Networking connectivity	The minimum bandwidth in case of VSAT last mile at each location for each ATM should be dedicated 64 Kbps with 100% concurrency (demand as on today) in extended C Band. Per ATM bandwidth requirement should match with the day-to-day requirement.	We request bank that it is understood that the BW is required as 32 Kbps up and 32 kbps Down. Kindly clarify the requirement.	<b>CORRIGENDUM:</b> <del>The minimum bandwidth in case of VSAT last mile at each location for each ATM should be dedicated 64 Kbps with 100% concurrency (demand as on today) in extended C Band. Per ATM bandwidth requirement should match with the day-to-day requirement.</del> <b>Minimum bandwidth in case of VSAT last mile at each location for each ATM should be dedicated 32 Kbps for upload &amp; download respectively with 100% concurrency (demand as on today). Further, if two or more ATMs are connected with same VSAT then bandwidth would be 64 kbps using (Number of ATMs X Bandwidth) formula. However, this is applicable for VSAT connectivity only. The dedicated bandwidth should be adequately provided to carry out transactions smoothly.</b>

170	2.2.h	Networking connectivity	Bidder should also arrange for backhaul (from service providers BSNL, Bharti Airtel, Vodafone, TCL, Reliance JIO, Sify, Hughes, Tatanet, Railtel etc.) and other communication devices at bank PR and DR site and also ensure ATMs to Bank's Servers connectivity	We request bank , all network providers like Hughes ,Nelco ,Airtel ,Vodafone are having there backhuals at SBI DC & DR with redundancy. We request bank to clarify can we utilized same or we need to ask our network /VSAT providers to install new links .	Terms & Conditions applicable as per RFP. Clarification: bidder has to comply Bank's IT security policy meticulously.
170	2.2.i	Networking connectivity	The backhaul link each between Networks service provider's Hub / NOC, to Banks' Data Centers and Disaster Recovery Centers should be configured with end-to-end IP Sec should support AES, GCM, SHA2 or any latest encryption which Bank may ask as per requirement during the contract period.	Encryption (AES, GCM, SHA2) are this mandatory requirement; Would request bank to Please clarify	Terms & Conditions applicable as per RFP. Clarification: bidder has to comply Bank's IT security policy meticulously.

170	2.2 Offsite Endpoints: h)	Bidder should also arrange for backhaul (from service providers BSNL, Bharti Airtel, Vodafone, TCL, Reliance JIO, Sify, Hughes, Tatanet, Railtel etc.), backhauls for connecting to the Bank's ATM Switch and DR.	Existing service providers may use the Backhaul links by upgrading the Bandwidth as needed.	Terms & Conditions applicable as per RFP. Clarification: bidder has to comply Bank's IT security policy meticulously.
-----	---------------------------	---	---	---

171	2.2 (j)	NETWORKING / CONNECTIVITY OF ATMS	Management Centre of the Bidder also need to be connected to Banks' Data Centres and Disaster Recovery Centres for monitoring purpose, if required by the Bank. The cost of leased line and back up connectivity from the Bidder's Management Centre and DR Site to the Bank's Switch and DR Site must be borne by the bidder. The recurring expenditure relating to connectivity shall be borne by bidder. Cost of licenses / software / hardware / services, etc. required to provide the Services will be borne by the bidder.	Any additional requirements including connectivity, cost of licenses, software, hardware services shall be charged by the Vendor as mutually agreed by the Parties	Terms & Conditions applicable as per RFP. Clarification: bidder has to comply Bank's IT security policy meticulously.
172	2.2	Offsite Endpoints: s)	If rack is required at DC / DR location the rack specification should match with SBI DC standard rack specifications.	We would recommend SBI to provide rack space for equipments, in case SBI cannot provide the same, please share the approved standard rack specifications.	Terms & Conditions applicable as per RFP

172	2.2	Offsite Endpoints-t-ii	<p>IPsec tunnel for the traffic from ATM to Banks' Data Centres and Disaster Recovery Centres, as advised by the bank to ensure data confidentiality.</p>	<p>the requirement envisage, 4G/ 5G as a prefer mod eof connectivity and SIM utilize should be private APN SIM. Wherein , network service provider transfer the data over secure tunnel up to service provider DC/ HUB.</p> <p>2. Also as per RFP requirement the service provider will route the traffic to bank DC / DR by creating secure IPSEC tunnel</p> <p>3. as per our understanding there will be a application layer security in form of TLS and HDE is present at ATM level.</p> <p>Hence it is suggested that there is no requirement of additional layer of end to end IPSEC tunnel.</p> <p>So requesting bank to remove the clause no 2.2 Offsite Endpoints-t-ii</p>	<p>Terms &amp; Conditions applicable as per RFP. Clarification: bidder has to comply Bank's IT security policy meticulously.</p>
-----	-----	------------------------	---	--	--

172	2.2	Offsite Endpoints-t-ii	<p>IPsec tunnel for the traffic from ATM to Banks' Data Centres and Disaster Recovery Centres, as advised by the bank to ensure data confidentiality.</p>	<p>the requirement envisage, 4G/ 5G as a prefer mod eof connectivity and SIM utilize should be private APN SIM. Wherein , network service provider transfer the data over secure tunnel up to service provider DC/ HUB.</p> <p>2. Also as per RFP requirement the service provider will route the traffic to bank DC / DR by creating secure IPSEC tunnel</p> <p>3. as per our understanding there will be a application layer security in form of TLS and HDE is present at ATM level.</p> <p>Hence it is suggested that there is no requirement of additional layer of end to end IPSEC tunnel.</p> <p>So requesting bank to remove the clause no 2.2 Offsite Endpoints-t-ii</p>	<p>Terms &amp; Conditions applicable as per RFP. Clarification: bidder has to comply Bank's IT security policy meticulously.</p>
-----	-----	------------------------	---	--	--

172	2.2	Offsite Endpoints-t-ii	<p>IPsec tunnel for the traffic from ATM to Banks' Data Centres and Disaster Recovery Centres, as advised by the bank to ensure data confidentiality.</p>	<p>the requirement envisage, 4G/ 5G as a prefer mod eof connectivity and SIM utilize should be private APN SIM. Wherein , network service provider transfer the data over secure tunnel up to service provider DC/ HUB.</p> <p>2. Also as per RFP requirement the service provider will route the traffic to bank DC / DR by creating secure IPSEC tunnel</p> <p>3. as per our understanding there will be a application layer security in form of TLS and HDE is present at ATM level.</p> <p>Hence it is suggested that there is no requirement of additional layer of end to end IPSEC tunnel.</p> <p>So requesting bank to remove the clause no 2.2 Offsite Endpoints-t-ii</p>	<p>Terms &amp; Conditions applicable as per RFP. Clarification: bidder has to comply Bank's IT security policy meticulously.</p>
-----	-----	------------------------	---	--	--

172	2.2 (t-ii)	Offsite Endpoints	IPsec tunnel for the traffic from ATM to Banks' Data Centres and Disaster Recovery Centres, as advised by the bank to ensure data confidentiality.	<p>the requirement envisage, 4G/ 5G as a prefer mod eof connectivity and SIM utilize should be private APN SIM. Wherein , network service provider transfer the data over secure tunnel up to service provider DC/ HUB.</p> <p>2. Also as per RFP requirement the service provider will route the traffic to bank DC / DR by creating secure IPSEC tunnel</p> <p>3. as per our understanding there will be a application layer security in form of TLS and HDE is present at ATM level.</p> <p>Hence it is suggested that there is no requirement of additional layer of end to end IPSEC tunnel.</p> <p>So requesting bank to remove the clause no 2.2 Offsite Endpoints-t-ii</p>	<p>Terms &amp; Conditions applicable as per RFP.</p> <p>Clarification: bidder has to comply Bank's IT security policy meticulously.</p>
-----	------------	-------------------	--	--	---



172	2.2 (v)	NETWORKING / CONNECTIVITY OF ATMS	The Vendor should carry out necessary configuration changes in their network, if in future the Bank decides to carry out design modification and / or application modification to the Banks' ATM network, including modification for the security policy implementation. The cost of such configuration modifications should be entirely borne by the Vendor.	Any additional requirements including configuration, design modification shall be charged by the Vendor as mutually agreed by the Parties	Terms & Conditions applicable as per RFP. Clarification: bidder has to comply Bank's IT security policy meticulously.
-----	---------	--------------------------------------	---	---	--

172	2.2 (x)	NETWORKING / CONNECTIVITY OF ATMS	Bidder shall carry out necessary configuration changes in their network, if in future the Bank decides to carry out design modification and/or application modification to the Banks' ATM network, including modification for the security policy implementation. The cost of such configuration modifications (including any hardware/software upgrades) shall be entirely borne by bidder. Non-compliance by bidders shall attract penalty of Rs. 5000 per day per endpoint from the end date advised by the Bank for compliance.	Any additional requirements including configuration, design modification shall be charged by the Vendor as mutually agreed by the Parties	Terms & Conditions applicable as per RFP. Clarification: bidder has to comply Bank's IT security policy meticulously.
172	2.2 Offsite Endpoints: s)	2.2 Offsite Endpoints: s)	If rack is required at DC / DR location the rack specification should match with SBI DC standard rack specifications.	We would recommend SBI to provide rack space for equipments, in case SBI cannot provide the same, please share the approved standard rack specifications.	Terms & Conditions applicable as per RFP

172	2.2 Offsite Endpoints: s)	If rack is required at DC / DR location the rack specification should match with SBI DC standard rack specifications.	If rack is required at DC / DR location the rack specification should match with SBI DC standard rack specifications.	We would recommend SBI to provide rack space for equipment's, in case SBI cannot provide the same, please share the approved standard rack specifications.	Terms & Conditions applicable as per RFP
172	2.2 Offsite Endpoints: s)		If rack is required at DC / DR location the rack specification should match with SBI DC standard rack specifications.	We would recommend SBI to provide rack space for equipments, in case SBI cannot provide the same, please share the approved standard rack specifications.	Terms & Conditions applicable as per RFP

172	2.2 Offsite Endpoints-t-ii	IPsec tunnel for the traffic from ATM to Banks' Data Centres and Disaster Recovery Centres, as advised by the bank to ensure data confidentiality.	IPsec tunnel for the traffic from ATM to Banks' Data Centres and Disaster Recovery Centres, as advised by the bank to ensure data confidentiality.	<p>the requirement envisage, 4G/ 5G as a prefer mod eof connectivity and SIM utilize should be private APN SIM. Wherein , network service provider transfer the data over secure tunnel up to service provider DC/ HUB.</p> <p>2. Also as per RFP requirement the service provider will route the traffic to bank DC / DR by creating secure IPSEC tunnel</p> <p>3. as per our understanding there will be a application layer security in form of TLS and HDE is present at ATM level.</p> <p>Hence it is suggested that there is no requirement of additional layer of end to end IPSEC tunnel.</p> <p>So requesting bank to remove the clause no 2.2 Offsite Endpoints-t-ii</p>	<p>Terms &amp; Conditions applicable as per RFP. Clarification: bidder has to comply Bank's IT security policy meticulously.</p>
-----	----------------------------	--	--	--	--

172	2.2 Offsite Endpoints-t-ii	Networking connectivity	IPsec tunnel for the traffic from ATM to Banks' Data Centers and Disaster Recovery Centres, as advised by the bank to ensure data confidentiality.	<p>Based on the requirement envisaged, 4G/ 5G as a preferred mode of connectivity and SIM utilize should be private APN SIM. Wherein , network service provider transfer the data over secure tunnel up to service provider DC/ HUB.</p> <p>2. Also as per RFP requirement the service provider will route the traffic to bank DC / DR by creating secure IPSEC tunnel</p> <p>3. as per our understanding there will be a application layer security in form of TLS and HDE is present at ATM level.</p> <p>Hence it is suggested that there is no requirement of additional layer of end to end IPSEC tunnel.</p> <p>So requesting bank to remove the clause no 2.2 Offsite Endpoints-t-ii</p>	<p>Terms &amp; Conditions applicable as per RFP. Clarification: bidder has to comply Bank's IT security policy meticulously.</p>
-----	----------------------------	-------------------------	--	---	--

172	2.2 s)	Offsite Endpoints	If rack is required at DC / DR location the rack specification should match with SBI DC standard rack specifications.	We would recommend SBI to provide rack space for equipments, in case SBI cannot provide the same, please share the approved standard rack specifications.	Terms & Conditions applicable as per RFP
172	2.2(s)	Appendix E - Scope of Work- - Networking and Connectivity of ATMs	If rack is required at DC / DR location the rack specification should match with SBI DC standard rack specifications.	As per Network Service Provider 1 - Would like to request the Bank for providing dedicated rack space for networking equipments and arrange the standard rack specifications for sharing it with respective network service providers, with whom bidder will engage.	Terms & Conditions applicable as per RFP

172	2.2(t-ii)	Appendix E - Scope of Work- - Networking and Connectivity of ATMs	IPsec tunnel for the traffic from ATM to Banks' Data Centres and Disaster Recovery Centres, as advised by the bank to ensure data confidentiality.	<p>As per Network Service Provider 2 - The requirement envisage, 4G/ 5G as a preferred mode of connectivity and SIM utilize should be private APN SIM. Wherein , network service provider transfer the data over secure tunnel up to service provider DC/ HUB.</p> <p>2. Also as per RFP requirement the service provider will route the traffic to bank DC / DR by creating secure IPSEC tunnel</p> <p>3. as per our understanding there will be a application layer security in form of TLS and HDE is present at ATM level.</p> <p>Hence it is suggested that there is no requirement of additional layer of end to end IPSEC tunnel.</p> <p>So requesting bank to remove the clause no 2.2 Offsite Endpoints-t-ii</p>	<p>Terms &amp; Conditions applicable as per RFP.</p> <p>Clarification: bidder has to comply Bank's IT security policy meticulously.</p>
-----	-----------	---	--	---	---

172	x	Appendix-E	<p>Bidder shall carry out necessary configuration changes in their network, if in future the Bank decides to carry out design modification and/or application modification to the Banks' ATM network, including modification for the security policy implementation. The cost of such configuration modifications (including any hardware/software upgrades) shall be entirely borne by bidder. Non-compliance by bidders shall attract penalty of Rs. 5000 per day per endpoint from the end date advised by the Bank for compliance.</p>	<p>The bidder can't assume future change requirement from bank so any change required , we request to mutually decide the cost.</p>	<p>Terms &amp; Conditions applicable as per RFP. Clarification: bidder has to comply Bank's IT security policy meticulously.</p>
-----	---	------------	--	---	--



173	3.1	<p>Appendix E - Scope of Work  <b>ENDPOINT MIGRATION FROM MVS + EPS TO OEMS NATIVE SOFTWARE</b></p>	<p>In the event of Bank deciding to switch over from Multi-Vendor Software Solution and Endpoint Protection Solution to OEM's Native application, ATM should be capable of running OEM's native ATM software and its allied applications (if any) without any hardware changes. The Endpoint Provider will be responsible for testing, integration, commissioning and coordinating implementation of OEM's Native Software in already deployed (or to be deployed) ATMs, without any extra cost to the Bank, as per requirement(s) of the Bank.</p>	<p>This should be on mutually agreeable commercial terms</p>	<p>Terms &amp; Conditions applicable as per RFP</p>
-----	-----	---	---	--	---

173	3.1		<p>In the event of Bank deciding to switch over from Multi-Vendor Software Solution and Endpoint Protection Solution to OEM's Native application, ATM should be capable of running OEM's native ATM software and its allied applications (if any) without any hardware changes.</p>	<p><u>In case Bank decides to go with Native application,</u>          Requesting Bank to provide 18months or mutually agreed duration for implementing Native application runs on Windows operating system</p>	<p>Terms &amp; Conditions applicable as per RFP</p>
173	3.1		<p>In the event of Bank deciding to switch over from Multi-Vendor Software Solution and Endpoint Protection Solution to OEM's Native application, ATM should be capable of running OEM's native ATM software and its allied applications (if any) without any hardware changes.</p>	<p><u>In case Bank decides to go with Native application,</u>          Requesting Bank to provide 18months or mutually agreed duration for implementing Native application runs on Windows operating system</p>	<p>Terms &amp; Conditions applicable as per RFP</p>

174	iv		<p><b>Support for Operating System</b></p> <ul style="list-style-type: none"> <li>• Windows 11 / permitted Windows 10, patches, service packs etc.</li> <li>• Changes in Operating System or its configuration (environment variable, parameter changes, enabling / disabling services etc)</li> <li>• End-user License Agreement (EULA)</li> <li>• Any other relevant information including Best Practices</li> </ul>	<p><b><u>In case Bank decides to go with Native application,</u></b>  Request Bank to include Linux or modify clause as:  <b>Support for Operating System</b></p> <ul style="list-style-type: none"> <li>• Windows 11 / permitted Windows 10 / Linux , patches, service packs etc.</li> <li>• Changes in Operating System or its configuration (environment variable, parameter changes, enabling / disabling services etc)</li> <li>• End-user License Agreement (EULA)</li> <li>• Any other relevant information including Best Practices</li> </ul>	<p><b>Terms &amp; Conditions applicable as per RFP</b></p>
-----	----	--	--	--	--

174	iv		<p>Support for Operating System</p> <ul style="list-style-type: none"> <li>• Windows 11 / permitted Windows 10, patches, service packs etc.</li> <li>• Changes in Operating System or its configuration (environment variable, parameter changes, enabling / disabling services etc)</li> <li>• End-user License Agreement (EULA)</li> <li>• Any other relevant information including Best Practices</li> </ul>	<p><u>In case Bank decides to go with Native application,</u> Request Bank to include Linux or modify clause as: Support for Operating System</p> <ul style="list-style-type: none"> <li>• Windows 11 / permitted Windows 10 / Linux , patches, service packs etc.</li> <li>• Changes in Operating System or its configuration (environment variable, parameter changes, enabling / disabling services etc)</li> <li>• End-user License Agreement (EULA)</li> <li>• Any other relevant information including Best Practices</li> </ul>	<p>Terms &amp; Conditions applicable as per RFP</p>
175	3.1(Vi)		Cheque Readers and Scanners	It is mentioned about cheque reader & scanner, but OEM details are not available with RFP	<b>CORRIGENDUM:</b> <del>Cheque Readers and Scanners</del>

176	3.2 h)	3.2 Centralized Electronic Journal (EJ) Pulling	<p>ATM-wise EJs should be stored in the EJ server of the Vendor at a Centralized location for minimum period of 180 days. Bidder to ensure EJ pulling from the ATM at specified time as per Bank / vendor's specifications. ATM-Wise EJs pulled are to be spooled separately and pushed to the designated server on daily basis. ATM-wise EJ data should be made available for a minimum period of twelve months. The EJ data may be purged by the Bidder after seeking confirmation of the Bank, after taking necessary Backup and handing over this backup to Bank's Team</p>	<p>Since MVS would be done from Day-1, EJ will be pulled by the Bank's MVS vendor. We request Bank to instruct MVS vendor to provide reporting views and access as required by MSP to ensure effectiveness of EJ pulling</p>	<p>Terms &amp; Conditions applicable as per RFP. Clarification: This is in Case of Migration From MVS+EPS to OEMs Native Software.</p>
-----	--------	---	---	--	--

176	3.2(f)	Appendix-E	<p>ATM-wise EJs should be stored in the EJ server of the Vendor at a Centralized location for minimum period of 180 days. Bidder to ensure EJ pulling from the ATM at specified time as per Bank / vendor's specifications. ATM-Wise EJs pulled are to be spooled separately and pushed to the designated server on daily basis. ATM-wise EJ data should be made available for a minimum period of twelve months. The EJ data may be purged by the Bidder after seeking confirmation of the Bank, after taking necessary Backup and handing over this backup to Bank's Team.</p>	<p>(a) Ej has to be stored in Bank's server i- Alert or vendor has to do at own server also as mentioned. (b) EJ has to be saved for 180 days or 12 months.</p>	<p>Terms &amp; Conditions applicable as per RFP. Clarification: This is in Case of Migration From MVS+EPS to OEMs Native Software.</p>
-----	--------	------------	--	---	--

177	3.2	Centralized Electronic Journal (EJ) Pulling:	n) EJ Penalties→ EJ Disconnected / Disputed Cases / Incomplete EJ / unavailable EJ: The following penalties shall be applicable for non-performance / delayed performance of EJ related activities due to non-working of EJ module. Bank shall levy a penalty of Rs. 1,000/- per instance per day in case of:	Penalty on EJ Bidder is requesting Bank to reduce this penalty to 100 Rs	Terms & Conditions applicable as per RFP. Clarification: This is in Case of Migration From MVS+EPS to OEMs Native Software.
177	3.2.1(n)	Appendix E - Scope of Work Centralized Electronic Journal (EJ) Pulling	EJ Penalties→ EJ Disconnected / Disputed Cases / Incomplete EJ / unavailable EJ: The following penalties shall be applicable for non-performance / delayed performance of EJ related activities due to non-working of EJ module. Bank shall levy a penalty of Rs. 1,000/- per instance per day in case of	As Bidder has to align the engineer physically at site for fetching the EJ, would request the Bank to make this TAT as T+3 days so as to ensure that the settlement timelines are also not impacted. Additionally have an exclusion for cases such as force majeure, vandalism, spare requirements, etc. Also there should not be any penalty since the disputed amount itself is a higher enough penalty.	Terms & Conditions applicable as per RFP. Clarification: This is in Case of Migration From MVS+EPS to OEMs Native Software.

178	d)		The screen distribution should be platform independent – should support Windows 11 / permitted Windows-10 operating systems normally installed on Banks ATMs.	<u>In case Bank decides to go with Native application,</u> Request Bank to include Linux or modify clause as: The screen distribution should be platform independent – should support Windows 11 / permitted Windows-10 / Linux operating systems normally installed on Banks ATMs.	Terms & Conditions applicable as per RFP. Clarification: This is in Case of Migration From MVS+EPS to OEMs Native Software.
178	d)		The screen distribution should be platform independent – should support Windows 11 / permitted Windows-10 operating systems normally installed on Banks ATMs.	<u>In case Bank decides to go with Native application,</u> Request Bank to include Linux or modify clause as: The screen distribution should be platform independent – should support Windows 11 / permitted Windows-10 / Linux operating systems normally installed on Banks ATMs.	Terms & Conditions applicable as per RFP. Clarification: This is in Case of Migration From MVS+EPS to OEMs Native Software.



179	3.4 Provision of DVSS Images / Footages f)		f) If the vendor fails to provide the DVSS footage within 1 day when required by the Bank (within 180 days of the incident), for any reason including settlement of complaints within a reasonable time, the vendor will be liable to pay a penalty of Rs. 1,000/= per instance or the amount of penalty / loss suffered by the Bank on account of non-availability of such DVSS footage, whichever is higher.	Footage submission timeframe should be as per regulator guidelines of resolving dispute onus/offus.	Terms & Conditions applicable as per RFP. Clarification: This is in Case of Migration From MVS+EPS to OEMs Native Software.
179	3.4(e)(f)	Provision of DVSS Images / Footages	Endpoint Provider shall arrange to store DVSS footages up to a period of 180 days. DVSS Images backup and EJ Backup as and when required by the Bank and during preventive maintenance shall be done by the Vendor without any additional cost to the Bank.	Cash Slot footage also will be pulled by the MVS Vendor. Storage and non-availability should be the MVS vendor responsibility Bidder shall not be liable for DVSS not available within 180 days.	Terms & Conditions applicable as per RFP. Clarification: This is in Case of Migration From MVS+EPS to OEMs Native Software.

180	4.1	Site Implementation Services (SIS)	Bidder shall conduct site identification exercise and offer suitable site in the vicinity of locations desired by the Bank. Vendor cannot refuse installation of Endpoints at the site desired by the Bank. In case of refusal or non-installation of Endpoint at the site desired by the Bank within 30 days of issuance of PO, a penalty equal to Rs. 5,000 per day will be charged to the vendor.	Requesting Bank to consider Max 1000 penalty	<b>CORRIGENDUM:</b> Bidder shall conduct site identification exercise and offer suitable site in the vicinity of locations desired by the Bank. Vendor cannot refuse installation of Endpoints at the site desired by the Bank. In case of refusal or non-installation of Endpoint at the site desired by the Bank within 30 days of issuance of PO, a penalty equal to <del>Rs. 5,000</del> Rs.1,000/- per day will be charged to the vendor.
180	4.1 ( c) iv	Appendix E - Scope of Work Site Implementation Services (SIS)	Ramps must be provided at all sites. Vendor should fulfil all existing and time to time issued government / statutory guidelines in this regard. If RAMP is not feasible at the existing site, the ATM lobby should be shifted to a site with RAMP, after Bank's approval.	Need clarity on existing sites Ramp	<b>CORRIGENDUM:</b> <del>Ramps should be provided at all sites</del> All ATM sites should be equipped with RAMP facility as per regulatory guidelines. Vendor should fulfil all existing and time to time issued government / statutory guidelines in this regard. <del>If RAMP is not feasible at the existing site, the ATM lobby should be shifted to a site with RAMP, after Bank's approval.</del>

180	4.1 a	4.1 Site Implementation Services (SIS)	Bidder shall conduct site identification exercise and offer suitable site in the vicinity of locations desired by the Bank. Vendor cannot refuse installation of Endpoints at the site desired by the Bank. In case of refusal or non-installation of Endpoint at the site desired by the Bank within 30 days of issuance of PO, a penalty equal to Rs. 5,000 per day will be charged to the vendor.	Penalty of Rs. 5000/- per machine per day is very high. We would request Bank to reduce the penalty to Rs. 1000/- per machine per day.	<b>CORRIGENDUM:</b> Bidder shall conduct site identification exercise and offer suitable site in the vicinity of locations desired by the Bank. Vendor cannot refuse installation of Endpoints at the site desired by the Bank. In case of refusal or non-installation of Endpoint at the site desired by the Bank within 30 days of issuance of PO, a penalty equal to <del>Rs. 5,000</del> Rs.1,000/- per day will be charged to the vendor.
-----	-------	--	--	--	---

180	4.1 a	<p>Bidder shall conduct site identification exercise and offer suitable site in the vicinity of locations desired by the Bank. Vendor cannot refuse installation of Endpoints at the site desired by the Bank. In case of refusal or non-installation of Endpoint at the site desired by the Bank within 30 days of issuance of PO, a penalty equal to Rs. 5,000 per day will be charged to the vendor.</p>	<p>Bidder shall conduct site identification exercise and offer suitable site in the vicinity of locations desired by the Bank. Vendor cannot refuse installation of Endpoints at the site desired by the Bank. In case of refusal or non-installation of Endpoint at the site desired by the Bank within 30 days of issuance of PO, a penalty equal to Rs. 5,000 per day will be charged to the vendor.</p>	<p>Penalty of Rs. 5000/- per machine per day is very high. We would request Bank to reduce the penalty to Rs. 1000/- per machine per day.</p>	<p><b>CORRIGENDUM:</b>  Bidder shall conduct site identification exercise and offer suitable site in the vicinity of locations desired by the Bank. Vendor cannot refuse installation of Endpoints at the site desired by the Bank. In case of refusal or non-installation of Endpoint at the site desired by the Bank within 30 days of issuance of PO, a penalty equal to <del>Rs.5,000</del> <b>Rs.1,000/-</b> per day will be charged to the vendor.</p>
-----	-------	---	---	---	--

180	4.1	Site Implementation Services (SIS)	iv. Ramps must be provided at all sites. Vendor should fulfil all existing and time to time issued government / statutory guidelines in this regard. If RAMP is not feasible at the existing site, the ATM lobby should be shifted to a site with RAMP, after Bank's approval	1.Ramp feasibility will remain challenge due to 1:12 slope and roughly 95% sites will become not feasible. Bidder request bank to consider RAMP at only feasible sites	<b>CORRIGENDUM:</b> <del>Ramps should be provided at all sites</del> All ATM sites should be equipped with RAMP facility as per regulatory guidelines. Vendor should fulfil all existing and time to time issued government / statutory guidelines in this regard. <del>If RAMP is not feasible at the existing site, the ATM lobby should be shifted to a site with RAMP, after Bank's approval.</del>
180	4.1(a)	Appendix E - Scope of Work Site Implementation Services (SIS)	Bidder shall conduct site identification exercise and offer suitable site in the vicinity of locations desired by the Bank. Vendor cannot refuse installation of Endpoints at the site desired by the Bank. In case of refusal or non-installation of Endpoint at the site desired by the Bank within 30 days of issuance of PO, a penalty equal to Rs. 5,000 per day will be charged to the vendor.	Would request the Bank to provide the following:  1. 150 Financial Transactions + 50 Non-Financial Transactions MG on sites recommended by the Bank  2. Penalty waiver for the 1st year of Operation since these sites are subject to multiple feasibilities  3. The Penalty of INR 5000 per day after 30 days is also too steep and would require the Bank's reconsideration  4. Reimbursement of Rentals	<b>CORRIGENDUM:</b> Bidder shall conduct site identification exercise and offer suitable site in the vicinity of locations desired by the Bank. Vendor cannot refuse installation of Endpoints at the site desired by the Bank. In case of refusal or non-installation of Endpoint at the site desired by the Bank within 30 days of issuance of PO, a penalty equal to <del>Rs. 5,000</del> Rs.1,000/- per day will be charged to the vendor.

				for all such sites with rentals more than 10K per month	
180	4.1..b	SIS	There can be instances wherein the Bidders are assigned their old / existing sites which were under Bank's earlier MOF / TOM Agreements. At all such sites, the bidders should renovate / modify them as per the approved 3D representation of sites.	We request bank to consider the change , the selected bidder need to perform fresh SIS work from zero. This is new tender so allowing renovation of site will not full fill the RFP purpose.	<b>CORRIGENDUM:</b> There can be instances wherein the Bidders are assigned their old / existing sites which were under Bank's earlier MOF / TOM Agreements. At all such sites, the bidders should <del>renovate / modify</del> <b>refurbished /renew</b> them as per the approved 3D representation of sites.

180	4.1..b	SIS	<p>There can be instances wherein the Bidders are assigned their old / existing sites which were under Bank's earlier MOF / TOM Agreements. At all such sites, the bidders should renovate / modify them as per the approved 3D representation of sites.</p>	<p>We request bank to clarify if minor repair work in in the site including all the equipment including VSAT, AC, UPS, electrical items, Signage and some minor civil, electrical work can be done to make the site looking new or all new items including ATM, VSAT, AC, UPS, electrical items, Signage needs to be provided and the entire SIS work including civil, electrical work needs to be done as new.</p> <p>Please clarify this point.</p>	<p><b>CORRIGENDUM:</b> There can be instances wherein the Bidders are assigned their old / existing sites which were under Bank's earlier MOF / TOM Agreements. At all such sites, the bidders should <del>renovate / modify</del> <b>refurbished /renew</b> them as per the approved 3D representation of sites.</p>
180	4.1.a	SIS	<p>a) Bidder shall conduct site identification exercise and offer suitable site in the vicinity of locations desired by the Bank. Vendor cannot refuse installation of Endpoints at the site desired by the Bank. In case of refusal or non-installation of Endpoint at the site desired by the Bank within 30 days of issuance of PO, a penalty equal to Rs.</p>	<p>AGSTTL suggested to increase the installation of END point 30 days to 45 days at for Rural or remote site to complete the SIS work along with delivery of CD and other equipments may take transit time more than urban site.</p>	<p><b>CORRIGENDUM:</b> Bidder shall conduct site identification exercise and offer suitable site in the vicinity of locations desired by the Bank. Vendor cannot refuse installation of Endpoints at the site desired by the Bank. In case of refusal or non-installation of Endpoint at the site desired by the Bank within 30 days of issuance of PO, a penalty equal to <del>Rs.5,000</del> <b>Rs.1,000/-</b> per day will be charged to the vendor.</p>

			5,000 per day will be charged to the vendor.		
180	4.1.a	SIS	Bidder shall conduct site identification exercise and offer suitable site in the vicinity of locations desired by the Bank. Vendor cannot refuse installation of Endpoints at the site desired by the Bank. In case of refusal or non- installation of Endpoint at the site desired by the Bank within 30 days of issuance of PO, a penalty equal to Rs.	We request bank to increase timeline for installation of ATM because after PO or Site list there are multiple work to be performed by vendor i.e. Select site , get approval from Bank , Perform SIS etc. Also requesting bank to reduce penalty to 1,000 overall for that ATM in place 5,000 per day.	<b>CORRIGENDUM:</b> Bidder shall conduct site identification exercise and offer suitable site in the vicinity of locations desired by the Bank. Vendor cannot refuse installation of Endpoints at the site desired by the Bank. In case of refusal or non- installation of Endpoint at the site desired by the Bank within 30 days of issuance of PO, a penalty equal to <del>Rs.5,000</del> Rs.1,000/- per day will be charged to the vendor.



			5,000 per day will be charged to the vendor.		
180	4.1a	Site Implementation Services (SIS)	Bidder shall conduct site identification exercise and offer suitable site in the vicinity of locations desired by the Bank. Vendor cannot refuse installation of Endpoints at the site desired by the Bank. In case of refusal or non-installation of Endpoint at the site desired by the Bank within 30 days of issuance of PO, a penalty equal to Rs.	This is not relevant in case of this model hence it should be removed	<b>CORRIGENDUM:</b> Bidder shall conduct site identification exercise and offer suitable site in the vicinity of locations desired by the Bank. Vendor cannot refuse installation of Endpoints at the site desired by the Bank. In case of refusal or non-installation of Endpoint at the site desired by the Bank within 30 days of issuance of PO, a penalty equal to <del>Rs.5,000</del> <b>Rs.1,000/-</b> per day will be charged to the vendor.

			5,000 per day will be charged to the vendor.		
181	4.1 ( c) vi	Appendix E - Scope of Work Site Implementation Services (SIS)	The Vendor will, however, seek confirmation about the Bank's link branch for Cash Replenishment which, in normal course, will be advised within one week by the Bank	If the ATMs are planned to be installed in semiurban and rural locations, we would need support from the bank to allocate the proposed feasible feeder branch by the Bidder. Since cassette swaps and daily loading/EOD would be difficult to manage from the bank's proposed long distance/non-feasible feeder branches.	Terms & Conditions applicable as per RFP

181	4.1 ( c) xii	Appendix E - Scope of Work Site Implementation Services (SIS)	Bank's prior approval is required to be obtained, in case the Vendor desires to relocate any of the endpoint for reasons other than request from the Bank at own cost	We anticipate, that the cost will be borne by the Bank for any relocation recommended by Bank. Please confirm.	Terms & Conditions applicable as per RFP.
181	vi.	c) Offsite locations:	The Vendor will, however, seek confirmation about the Bank's link branch for Cash Replenishment which, in normal course, will be advised within one week by the Bank.	Request to bank to assign single nodal branch for cash collection and submission of reports and better operation efficiency.	Terms & Conditions applicable as per RFP
181	XIV	Offsite	Selected Vendor will not install its White Label ATM(s) / ADWM(s) / White Label Mobile ATM / White Label Mobile ADWM within vicinity of 500 metre of SBI ATM / ADWM.	As we understand with this clause that bank want protect / increase transaction. We request bank to increase the vicinity distance to at-least radius of 1.5km.	<b>CORRIGENDUM:</b> Selected Vendor will not install its White Label ATM(s) / ADWM(s) / White Label Mobile ATM / White Label Mobile ADWM within vicinity of <del>500</del> 1000 metre of SBI ATM / ADWM. Bidder shall immediately inform the Bank, if White Label ATM(s) / ADWM(s) / White Label Mobile ATM / White Label Mobile ADWM is / are running within the proximity of 1000 metre of SBI ATM/ADWM.

182	4.1.1 - ix	Site Implementation Services (SIS)	Ramps should be mandatorily available. RAMPs with stainless Steel railings should be made for disabled customers to reach the ATM room easily.	Request Bank to allow Steel apart from Stainless Steel for the railing since is equally durable.	<b>CORRIGENDUM:</b> <del>Ramps should be mandatorily available</del> All ATM sites should be equipped with RAMP facility as per regulatory guidelines. RAMPs with stainless Steel railings should be made for disabled customers to reach the ATM room easily.
182	Para 4.1.1(iii)		SBI "ATM" refers to a site with single type of ATM machine which only dispenses cash whereas SBI "e-Corner" refers to site with multiple types of machines like ATM, ADWM, Swayam, Coin Vending Machine, Cheque Deposit Machine etc.	Is vendor required to replace Coin vending & cheque deposit machine ?	Terms & Conditions applicable as per RFP Clarification: this RFP is only for ATM machines.
183	4.1.1 (Point xii)	Site Work Specifications – General guidelines	Backroom	Specifications required	Terms & Conditions applicable as per RFP

185	4.1.1 - xii	Site Implementation Services (SIS)	Uniform façade: The ATM Room shall have full glass door entrance and other non-entry glass panes. Depending on the site size, there can be multiple non-entry glass panes. On each glass pane, generic see-through sticker films are to be pasted.	We request Bank to consider and remove this point in view of SECURITY perspective. ATM room should be visible from outside to control Vandalism etc.	Terms & Conditions applicable as per RFP. Clarification: Already given generic see-through sticker films.
190	4.1.2	FLOORING	Double charges nano-polish vitrified tile flooring of size 800 X 800 mm / 800 X 1200 mm, Antiskid, AS PER DSR 11.41.2/ 11.49.2 (8-10 mm thick) Colour – Ivory, White Base	We request bank to change the stander size as the given tiles size not available in remote locations	Terms & Conditions applicable as per RFP
190	4.1.2	Site Work Specifications	Room Flooring nano-polish verified tile flooring of size 800X800 / 800X1200 mm	it should be 600X600 as availability will be concern at rural area	Terms & Conditions applicable as per RFP
190	4.1.2 (Point 1) (a)	Site Work Specifications	Flooring of Room	tile given is 800x800 which will be difficult to get everywhere. Normally it is 600x600	Terms & Conditions applicable as per RFP
190	4.1.2 (Point 1) (b)	Site Work Specifications	Flooring of external steps	Normally not done in any sites	Terms & Conditions applicable as per RFP

190	4.1.2	Site Work Specifications	<p><b>1. FLOORING</b>  Double charges nano-polish vitrified tile flooring Simpolo, Somany, Nitco, Johnson or of size 800 X 800 mm / 800 X 1200 mm, Anti-equivalent skid, AS PER DSR 11.41.2/ 11.49.2 (8-10 mm thick)  Colour – Ivory, White Base</p>	<p>Bidder ask bank to consider tiles standard size as 600mmx 600mm. It would be difficult get 800x 800 mm/ 800x1200mm in market and deploy sites within timeline as availability of stock always remains issue and maintenance would be difficult as its not standard size.</p>	<p>Terms &amp; Conditions applicable as per RFP</p>
191	5	Site Implementation Services (SIS)	<p>12mm thick toughened glass partition and door</p>	<p>Request Bank to accept 8 mm thick toughened glass partition and door</p>	<p>Terms &amp; Conditions applicable as per RFP</p>
191	4.1.2	. ENTRANCE DOOR	<p>12mm thick toughened glass partition and door</p>	<p>We suggest 8 MM Glass door with Aluminum Powder Coated</p>	<p>Terms &amp; Conditions applicable as per RFP</p>
191	4.1.2	FIXED GLAZING	<p>Providing and fixing external fixed glazing comprising of 10 mm Modifloat,</p>	<p>We suggest 8 MM Glass due to technical installation difficulties, and 10 MM glass is not available locally</p>	<p>Terms &amp; Conditions applicable as per RFP</p>

191	4.1.2	Site Work Specification	4. FIXED GLAZING - Providing and fixing external fixed glazing comprising of 10 mm Modifloat, Saint Gobain, Asahi make clear glass covered with 100 mm x 50 mm aluminium sections and clip with ..... colour mat finish powder coated (need transparent froster film on glass).		Terms & Conditions applicable as per RFP
191	4.1.2	Site Work Specification	5. ENTRANCE DOOR - <u>Providing and fixing frameless fully glazed 12mm thick toughened float glass door</u> fixed with necessary patch fittings (Dorma / Ozone / Godrej make) including cutting, making holes, cut-outs in the glass of required shape and size to accommodate fittings and fixing the fittings in floors, soffits, jams including necessary fixtures, screws, sealant wherever required	Please clarify that in description of entrance Door it is mentioned <u>Aluminium Powder Coated Extruded Section with 12 mm toughened glass</u> while in below description it is mentioned frameless . So clarify the exact scope of work.	<b>CORRIGENDUM</b> Providing and fixing frameless fully glazed 12mm thick toughened float glass door fixed with necessary patch fittings (Dorma / Ozone / Godrej <b>or equivalent make</b> ) including cutting, making holes, cut-outs in the glass of required shape and size to accommodate fittings and fixing the fittings in floors, soffits, jams including necessary fixtures, screws, sealant wherever required and SS cover over patch fittings.

			and SS cover over patch fittings.		
191	4.1.2	Site Work Specifications	5. ENTRANCE DOOR 12mm thick toughened glass partition and door .Aluminium Powder Coated Extruded Section, Patch Fitting & Floor Spring, Handle – SS 304 and 600 mm long, Self-Sticking Polyvinyl film – Artwork		Terms & Conditions applicable as per RFP



191	4.1.2 (Point 5)	Site Work Specifications	ENTRANCE DOOR	Since asked for Toughened glass and also powder coated framing. This both can not go. Framing is required only in case of normal glass	Terms & Conditions applicable as per RFP
191	4.1.2 (Point 5)	Site Work Specifications	Door - Fixed Glazing	Fixed glase is clear glass and Main door is toughened?	Terms & Conditions applicable as per RFP
191	4.1.2 (Point 5)	Site Work Specifications	ENTRANCE DOOR	frameless or with frame, also there is no toughen glass in door...	Terms & Conditions applicable as per RFP
191	4.1.2 (Point 5)	Site Work Specifications	Door - Fixed Glazing	Glass Should be 8 MM Max, section can't take load of 10MM Glass	Terms & Conditions applicable as per RFP
191	4.1.2 (Point 6) PAGE 191, 192	Site Work Specifications	ACP Panelling	COMPLETE SPECS REQUIRED	Terms & Conditions applicable as per RFP

191	6. INNER WALL COLOURS - ACP PANELLING( Fire Resistance Panel of 3mm)			<p>Need the Clarification on the Below Points:-</p> <p>1- Which Standard and Fire classification</p> <p>2- Thickness of Aluminium and type of Coating is Missing</p> <p>3-Alucobond (International Brand ) and one Indian Brand has mentioned i.e Alstrong which seems that it is inclined towards one brand only becuae Alucobond 3mm Regular retail product is not available easily in market.</p> <p>4-Requesting to Put the certified Product in terms of FR so that best product will be used in this Tender.</p>	Terms & Conditions applicable as per RFP
192	9	Site Implementation Services (SIS)	Should have the capability for motorized functioning of rolling up & down.	Request Bank to not make it mandatory to implement motorized rolling shutter as it will jam/ malfunction due to frequcnt usage. It will impact day to day services (incl CRA operations). Request Bank to accept normal rolling shutter.	<b>CORRIGENDUM:</b> Should have the capability for <del>motorized</del> functioning of rolling up & down
192	4.1.2	. GLASS DIVIDER BETWEEN MACHINES	12 mm thick Toughened Glass of size 4' X 6'	We suggest ACP partition for same 4' X 6'size	Terms & Conditions applicable as per RFP

192	4.1.2	POLLING SHUTTER	Should have the capability for motorized functioning of rolling up & dow	We request bank change the Motorized functioning as it is not feasible for ATM site. It would be manual shutter only.	Terms & Conditions applicable as per RFP
192	4.1.2	Site Work Specification	7. GLASS DIVIDER BETWEEN MACHINES - 12 mm thick Toughened Glass of size 4' X 6'	Please clarify about frameless or with frame or fixtures details to fix partition glass between m/c	Terms & Conditions applicable as per RFP
192	4.1.2 (Point 7)	Site Work Specifications	Glass Divider between machines	This can be replaced with Ply +ACP and easy to maintain	Terms & Conditions applicable as per RFP
192	4.1.2	Site Work Specifications	<p>9. ROLLING SHUTTER</p> <ul style="list-style-type: none"> <li>• Stutters should be installed at all ATM Sites.</li> <li>• Should have the capability for motorized functioning of rolling up &amp; down</li> <li>• Display ATM timings at entrance. Nearest ATMs address to be displayed at entrance.</li> <li>• Shutter should be lockable in 3 positions: - <ul style="list-style-type: none"> <li>o when rolled down completely,</li> <li>o rolled up completely and</li> <li>o when rolled up in half.</li> </ul> </li> </ul>	<p>Bidder request Bank to consider manual rolling shutter as motorized rolling shutter will not be feasible for all locations due to SPACE concern on sides of ATM room and inner portion of ATM room. Apart from this, Motorized rolling shutter has very limited/no service support available in Semi Urban and Rural areas, which will impact uptime of ATM</p>	<p><b>CORRIGENDUM:</b></p> <p><b>ROLLING SHUTTER</b></p> <ul style="list-style-type: none"> <li>• Stutters should be installed at all ATM Sites.</li> <li>• Should have the capability for <del>motorized</del> functioning of rolling up &amp; down</li> <li>• Display ATM timings at entrance. Nearest ATMs address to be displayed at entrance.</li> <li>• Shutter should be lockable in 3 positions: - <ul style="list-style-type: none"> <li>o when rolled down completely,</li> <li>o rolled up completely and</li> <li>o when rolled up in half.</li> </ul> </li> </ul>

192	4.1.2( 9)	<p><b>ROLLING SHUTTER</b></p> <ul style="list-style-type: none"> <li>• Stutters should be installed at all ATM Sites.</li> <li>• Should have the capability for motorized functioning of rolling up &amp; down</li> <li>• Display ATM timings at entrance. Nearest ATMs address to be displayed at entrance.</li> <li>• Shutter should be lockable in 3 positions: - <ul style="list-style-type: none"> <li>o when rolled down completely,</li> <li>o rolled up completely and</li> <li>o when rolled up in half.</li> </ul> </li> </ul>	<p>Bank want motorized rolling shutter with 3 positioning locking shutter, what if the same is not available at existing site?</p>	<p><b>CORRIGENDUM:</b></p> <p><b>ROLLING SHUTTER</b></p> <ul style="list-style-type: none"> <li>• Stutters should be installed at all ATM Sites.</li> <li>• Should have the capability for <del>motorized</del> functioning of rolling up &amp; down</li> <li>• Display ATM timings at entrance. Nearest ATMs address to be displayed at entrance.</li> <li>• Shutter should be lockable in 3 positions: - <ul style="list-style-type: none"> <li>o when rolled down completely,</li> <li>o rolled up completely and</li> <li>o when rolled up in half.</li> </ul> </li> </ul>
-----	-----------	--	--	--

192	Back Wall / False wall Panelling Ink Blue {L481- 105899 / RGB: 40 0 113 / HEX: #280071 / CMYK: 97 100 0 25} of Alucobond or equivalent from Alstrong			1- Seems it a typo error otherwise it seems to be close tender designed for Alstrong only	<b>CORRIGENDUM:</b> Ink Blue {L481-105899 / RGB: 40 0 113 / HEX: #280071 / CMYK: 97 100 0 25} of Alucobond, or equivalent from Alstrong or equivalent.+H648
193	10	Appendix E - Scope of Work Site Implementation Services (SIS)	1:12 slope to be provided for ramp	It is not practical to have a 1:12 for Offsite ATMs wherein there are either other shops nearby or it is near a Road. Would request the Bank to re- evaluate the specifications of RAMP	Terms & Conditions applicable as per RFP
193	10	RAMP FOR DISABLED	ALL SITES MUST HAVE RAMPS.	Depends on feasibility	Terms & Conditions applicable as per RFP

193	10c	Site Implementation Services (SIS)	1:12 slope to be provided for ramp	1:12 slope is extremely difficult at majority of sites as this needs minimum 12 feet length free space to build a RAMP. We request Bank to give flexibility wherever 1:12 slope for the RAMP is not feasible based on approval from Bank.	Terms & Conditions applicable as per RFP
193	4.1.2 (Point 10) & PAGE 390-397	Site Work Specifications & Appendix Q	RAMP	SITE MUST FEASIBLE FOR RAM AS PER SPECIFICATION OF RAMP	Terms & Conditions applicable as per RFP
193	4.1.2 (Point 10) & PAGE 390-397	Site Work Specifications & Appendix Q	RAMP	1:12 ratio to be maintain, all sites this may not be possible	Terms & Conditions applicable as per RFP
193	4.1.2 (Point 10) & PAGE 390-397	Site Work Specifications & Appendix Q	RAMP	Industry standard Ramp is 1:12 ration with steel railing. We will never get this much slop outside the shop. Should be avoided	Terms & Conditions applicable as per RFP
193	4.1.2 -10	Marketing Creatives / Posters	will be provided by bank	will be provided by Branch / LHO or Corporate center?	Terms & Conditions applicable as per RFP

193	4.1.2 -10	RAMP for disabled	1:12 slope to be provided for ramp	If the site is at 2ft height from the road level, it will be difficult to construct RAMP as per the specifications. For ground level sites no RAMPs will be required.	Terms & Conditions applicable as per RFP
197	12	SIS	Bilingual / Trilingual Stickers will be stuck behind the machine for identification. Example of machine-type stickers behind the machines:	We request bank to clarify more on sticker. As a bidder under this RFP the bidder is responsible for the machine deployed by them.	Terms & Conditions applicable as per RFP
199	4.1.2 (Point 14) (b)	Site Work Specifications	Cabling	for AC 4 sq.mm is now not required. Even the OEM supplies 1.5 sq.mm along with AC	Terms & Conditions applicable as per RFP
199	4.1.2 (Point 14) (b)	Site Work Specifications	Cabling	COMPLETE SPECS REQUIRED	Terms & Conditions applicable as per RFP
200	14 (d) iii	DISTRIBUTION BOARD FOR 3 PHASES	Incomer 40 Amp TPN DB with Outgoing MCB of 2 - 20 Amp, 4 – 10 Amp (Legrand, Simens, L&T or equivalent)	What we understand that this is just indicative not the part of DB. If required this shall be designed as separate DB. Bank to confirm on this understanding.	Terms & Conditions applicable as per RFP
200	4.1.2	Site Work Specification	(d) DISTRIBUTION BOARD FOR 3 PHASES	Suggested for single and three phase both options as to get three phase connection at many site is long time process and expensive which can be mandatory for E- corner while	Terms & Conditions applicable as per RFP

				ATM site can be operated on single phase.	
201	15(a)	Appendix E - Scope of Work EARTHING	Earthing to be taken from two opposite sides for ATM machine and dual earthing to be done with two separate earth pits. Earthing of raw power circuit should not interfere with UPS neutral earthing to avoid damage to ATM software and other electronic equipment connected to UPS	Single Earthing with Isolation Transformer suggested to fulfil the recommended requirement. Please confirm.	<b>CORRIGENDUM:</b> Earthing to be taken <del>from two opposite sides</del> for ATM machine and <del>dual</del> earthing to be done <del>with two separate</del> earth pits. Earthing of raw power circuit should not interfere with UPS neutral earthing to avoid damage to ATM software and other electronic equipment connected to UPS



201	4.1.2 -15	Earthing	Earthing to be taken from two opposite sides for ATM machine and dual earthing to be done with two separate earth pits. Earthing of raw power circuit should not interfere with UPS neutral earthing to avoid damage to ATM software and other electronic equipment connected to UPS	Single earthing is recommended as the site will not have that much space for double earthing	<b>CORRIGENDUM:</b> Earthing to be taken <del>from two opposite sides</del> for ATM machine and <del>dual</del> earthing to be done <del>with two separate</del> earth pits. Earthing of raw power circuit should not interfere with UPS neutral earthing to avoid damage to ATM software and other electronic equipment connected to UPS
-----	-----------	----------	--	--	--

202	20	EXTERNAL DIGITAL SIGNAGE SOLUTION (EDSS)	The bidder should arrange for testing the content to be displayed in digital signage, subject to approval of the Bank, before implementing at all sites. Bidder to ensure that no content without specific permission of Bank is displayed. No unsolicited / unwarranted content shall be displayed at any circumstances on EDSS. In case of non-compliance, penalty of Rs. 50,000 for each instance, along with any other penalty (ies) imposed on the Bank by any statutory body (ies), will be imposed and recovered from the bidder.	Need to revise penalty clause	Terms & Conditions applicable as per RFP
202	20	EXTERNAL DIGITAL SIGNAGE SOLUTION (EDSS)	EXTERNAL DIGITAL SIGNAGE SOLUTION (EDSS)	We understand there is a requirement of Signage license for Installation of Digital Signages which will be obtained from the Local Municipal Authorities. Bank to	Terms & Conditions applicable as per RFP: Please refer Clause No. of SIS 4.1, c), X. Page No. 181

				confirm who will be incharge for obtaining such permissions.	
202	20	EXTERNAL DIGITAL SIGNAGE SOLUTION (EDSS)	EXTERNAL DIGITAL SIGNAGE SOLUTION (EDSS)	Digital Signages are heavy in weight (approx. 40-50kgs) per signage considering 21 Sq. Ft, hence back support should be stronger to withhold the weight of Digital Signages for long tenure which may not be practically possible for a pre-requisite from site sourcing perspective.	Terms & Conditions applicable as per RFP
202	20	EXTERNAL DIGITAL SIGNAGE SOLUTION (EDSS)	EXTERNAL DIGITAL SIGNAGE SOLUTION (EDSS)	As EDSS is quite new to BFSI Sector, it would be difficult to meet the expected pace of deployment for such big numbers.	Terms & Conditions applicable as per RFP

202	19/20	<p>Appendix E - Scope of Work</p> <p>EXTERNAL BACKLIT SIGNAGE LIGHT</p> <p>EXTERNAL DIGITAL SIGNAGE SOLUTION (EDSS)</p>	<p>EXTERNAL BACKLIT SIGNAGE LIGHT</p> <p>(a) LED Light</p> <p>(b) All drivers of LED lights used in Backlit signage boards to be suitably covered with fire resistant boxes (Sintex box) to avoid seepage / moisture. Internal wiring of lights to be done using FRLS wires in flexible conduits and conduits to be fixed on signage frame.</p> <p>(c) The signage metal frame should be earthed on two opposite sides and properly earthed using bare copper.</p> <p>(d) The power supply to back lit signage to be provided with 30mA ELCB to ensure tripping in case of short circuits.</p> <p>EXTERNAL DIGITAL SIGNAGE SOLUTION (EDSS)</p> <p>Bank intends to opt for External Digital</p>	<p>Please clarify on specific requirements for the EXTERNAL BACKLIT SIGNAGE LIGHT and EXTERNAL DIGITAL SIGNAGE SOLUTION (EDSS) as there will be limited space, outside of any ATM lobby and putting as large as 21 sq. ft. signages will never be feasible at most of the sites.</p> <p>Also, the size of EDSS is different in two different places. On page 203, pt. J – it says the size shall be minimum 21 sq. ft. However, under the related Annexure 8 of EDSS, pt. 5 &amp; 6, the dimensions given are 320x160 mm and weight under 0.5 Kg.</p>	<p>Terms &amp; Conditions applicable as per RFP</p>
-----	-------	---	--	---	---

		<p>Signage Solutions (EDSS) at ATM sites as per its business requirement. Bidders shall arrange to install and maintain External Digital Signage Solution at the Sites advised by Bank to successful bidders, as per Bank's sole discretion. Bank may advise such site(s) time to time during the contract period. Bank shall pay additional Per Successful Transaction Rate as mentioned in the Appendix-F "Indicative Commercial Price Bid" wherever EDSS is installed and functional</p>		
--	--	---	--	--

202	20 (f)	EXTERNAL DIGITAL SIGNAGE SOLUTION (EDSS)	3D representation of the External Digital Signage placement is required to visualize the placing / need of static external signage along with Digital Signage. The static external signage will be necessary when the Digital RFP FOR TOM P-XVII 13,500 ATMs Signage is not working.	Here our understanding with static signage is normal Glow Sign Board. Is the bank looking for single frame having GSB along with Digital Signage. Bank to confirm on the same.	Terms & Conditions applicable as per RFP
-----	--------	--	--	--	--

202	20.e	EXTERNAL DIGITAL SIGNAGE SOLUTION (EDSS)	The bidder should arrange for testing the content to be displayed in digital signage, subject to approval of the Bank, before implementing at all sites. Bidder to ensure that no content without specific permission of Bank is displayed. No unsolicited / unwarranted content shall be displayed at any circumstances on EDSS. In case of non-compliance, penalty of Rs. 50,000 for each instance, alongwith any other penalty (ies) imposed on the Bank by any statutory body (ies), will be imposed and recovered from the bidder.	We request bank to cap penalty of 1000/-	Terms & Conditions applicable as per RFP
-----	------	--	---	--	--

202	4.1.2 -20-J	EXTERNAL DIGITAL SIGNAGE SOLUTION (EDSS)	Reputed ISI certified brands. The size of the External digital signage LED screen shall be advised by the bank for each such site. Size shall depend on the site, and it shall be minimum of 21 sq. ft.	it may not be possible to install 2 signages at site having 21 Sq.Ft. dimension	Terms & Conditions applicable as per RFP
-----	-------------	--	---	---	--



202	4.1.2	Site Work Specifications	<p><b>20. EXTERNAL DIGITAL SIGNAGE SOLUTION (EDSS)</b>  :Bank intends to opt for External Digital Signage Solutions (EDSS) at ATM sites as per its business requirement. Bidders shall arrange to install and maintain External Digital Signage Solution at the Sites advised by Bank to successful bidders, as per Bank’s sole discretion. Bank may advise such site(s) time to time during the contract period. Bank shall pay additional Per Successful Transaction Rate as mentioned in the Appendix-F “Indicative Commercial Price Bid” wherever EDSS is installed and functional.</p>	<p>Bidder request bank to remove digital signage from this RFP considering</p> <ol style="list-style-type: none"> <li>1. Limitations in sizes</li> <li>2. Network required is minimum of 4G- 5G (Wi-Fi)</li> <li>3. preferred network is LAN connectivity to avoid interception in screen display</li> <li>4. Not suitable for unmanned locations</li> <li>5.High lead times – upto 2 months per installation after recce by OEM and such, will go much higher outside of metros</li> <li>6.High energy consumption and will require a separate UPS Power failures / issues will mean a ‘dead’ (blank) signage</li> <li>7.LED panel model and spare availability is a constraint after 4 years, manufactures not ready to provide support beyond 1+3 years.</li> <li>8.Content management of screen change needs to be managed by bank.</li> <li>9.Additional MS structure work to be done at each sites to fix the LED panels as its heavy in weight, ATM site will have limiation for digital signage structure work.</li> <li>10. Very high upkeep and</li> </ol>	<p>Terms &amp; Conditions applicable as per RFP</p>
-----	-------	--------------------------	---	--	---

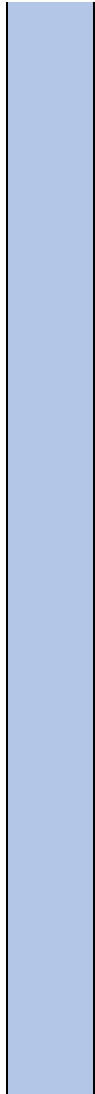

**maintenence required,  
leadtime for downcalls  
repair/parts replacement takes  
7-12 days for cities and rural  
areas requires upto 20 days**

203	20	EXTERNAL DIGITAL SIGNAGE SOLUTION (EDSS)	q. Bidder shall attend and rectify the Break down / repair / replacement of EDSS call(s) registered by Bank / Bank's representative within 2 days. Any repair / replacement / rectification / implantation task under EDSS advised by the Bank should be completed by the bidder within 2 days of intimation. Penalty @ ₹ 500 per day from the 3rd day onwards per non-complied call(s) will be levied.	The bidder requests the bank to consider 10 days for EDSS repair as it's a new type of signage being put the first time. Also request to consider no penalty for the same.	<b>CORRIGENDUM:</b> Bidder shall attend and rectify the Break down / repair / replacement of EDSS call(s) registered by Bank / Bank's representative within <b>2 4</b> days. Any repair / replacement / rectification / implantation task under EDSS advised by the Bank should be completed by the bidder within <b>2 4</b> days of intimation. Penalty @ ₹ 500 per day from the <del>3rd</del> <b>5th</b> day onwards per non-complied call(s) will be levied.
203	20 (J)	EXTERNAL DIGITAL SIGNAGE SOLUTION (EDSS)	Reputed ISI certified brands. The size of the External digital signage LED screen shall be advised by the bank for each such site. Size shall depend on the site, and it shall be minimum of 21 sq. ft.	There is no ISI Certified brands available for LED Signage however it is BIS Certified Standards.	<b>CORRIGENDUM:</b> Reputed <del>ISI</del> <b>BIS</b> certified brands. The size of the External digital signage LED screen shall be advised by the bank for each such site. Size shall depend on the site, and it shall be minimum of 21 sq. ft.

203	20 (j)	EXTERNAL DIGITAL SIGNAGE SOLUTION (EDSS)	Reputed ISI certified brands. The size of the External digital signage LED screen shall be advised by the bank for each such site. Size shall depend on the site, and it shall be minimum of 21 sq. ft.	Bank to confirm on the ratio of Flex Signage and the digital signage as the minimum sq. Ft considered by bank is 21 Sq. Ft for Digital signage.	Terms & Conditions applicable as per RFP
203	20 (p)	EXTERNAL DIGITAL SIGNAGE SOLUTION (EDSS)	Bidder shall have responsibility to upkeep the EDSS maximum time and also converting raw videos to required size, feeding into board and maintenance of cloud / software / SIM card etc.	We require the content file videos as per the variable ratios (Signage board size) as per the bank branding guidelines. Content file should be in a high resolution format.	Terms & Conditions applicable as per RFP

203	20 (q)	EXTERNAL DIGITAL SIGNAGE SOLUTION (EDSS)	Bidder shall attend and rectify the Break down / repair / replacement of EDSS call(s) registered by Bank / Bank's representative within 2 days. Any repair / replacement / rectification / implantation task under EDSS advised by the Bank should be completed by the bidder within 2 days of intimation. Penalty @ ₹ 500 per day from the 3 <sup>rd</sup> day onwards per non-complied call(s) will be levie	Atleast 7-8 working days in Metro Cities and 10-12 days in Non Metro Cities to attend and rectify the Breakdown/Repair/Replacement calls. 2 Days practically is not possible.	<b>CORRIGENDUM:</b> Bidder shall attend and rectify the Break down / repair / replacement of EDSS call(s) registered by Bank / Bank's representative within <b>2 4</b> days. Any repair / replacement / rectification / implantation task under EDSS advised by the Bank should be completed by the bidder within <b>2 4</b> days of intimation. Penalty @ ₹ 500 per day from the <del>3<sup>rd</sup></del> <b>5<sup>th</sup></b> day onwards per non-complied call(s) will be levied.
203	20.g	EXTERNAL DIGITAL SIGNAGE SOLUTION (EDSS)	Separate Network connectivity to be provided for Digital Signage for Centrally pushing of contents, NOT the connectivity used for ATM(s). Bidder can use the connectivity used for e-Surveillance Systems. GSM / VPN 3G / 4G / 5G multi-SIM intelligent Router	We request the bank to do External Digital Signage locally from the branch and remove the same from the BOQ.	Terms & Conditions applicable as per RFP

			with bandwidth aggregator.		
203	20.i	EXTERNAL DIGITAL SIGNAGE SOLUTION (EDSS)	Bidder shall provide a centralized dashboard for monitoring the contents being displayed on EDSS. Access to the centralized dashboard should be provided to the Bank.	We request the bank to get the functionality developed in MVS for common dashboard.	Terms & Conditions applicable as per RFP

203	20q	Site Implementation Services (SIS)	<p><b>EXTERNAL DIGITAL SIGNAGE SOLUTION (EDSS).</b></p> <p>Bidder shall attend and rectify the Break down / repair / replacement of EDSS call(s) registered by Bank / Bank's representative within 2 days. Any repair / replacement / rectification / implantation task under EDSS advised by the Bank should be completed by the bidder within 2 days of intimation. Penalty @ ₹ 500 per day from the 3rd day onwards per non-complied call(s) will be levied.</p>	<p>EDSS is a relatively expensive solution. While we understand it is an optional item, the proposed pricing of EDSS is less. We would request Bank to consider increase pricing for EDSS to 10% of successful financial and non-financial transaction.</p>	<p>Terms &amp; Conditions applicable as per RFP</p>
-----	-----	------------------------------------	---	---	---

203	4.1.2 - 20	EXTERNAL DIGITAL SIGNAGE SOLUTION (EDSS)	<p>Separate Network connectivity to be provided for Digital Signage for Centrally pushing of contents, NOT the connectivity used for ATM(s). Bidder can use the connectivity used for e-Surveillance Systems. GSM /VPN 3G / 4G / 5G multi-SIM intelligent Router with bandwidth aggregator</p>	<p>Please mandate separate Connectivity only and bank should not allow to use ESS connectivity since Digital Signage and ESS both are media content and there is large possibility to have hindrance in the over all scheme</p>	<p>Terms &amp; Conditions applicable as per RFP</p>
203	4.1.20(g)		<p>Separate Network connectivity to be provided for Digital Signage for Centrally pushing of contents, NOT the connectivity used for ATM(s). Bidder can use the connectivity used for e-Surveillance Systems. GSM / VPN 3G / 4G / 5G multi-SIM intelligent Router with bandwidth aggregator.</p>	<p>Request the bank to permit usage of ATM connectivity</p>	<p>Terms &amp; Conditions applicable as per RFP</p>



203	g	-	<p>Separate Network connectivity to be provided for Digital Signage for Centrally pushing of contents, NOT the connectivity used for ATM(s). Bidder can use the connectivity used for e-Surveillance Systems. GSM / VPN 3G / 4G / 5G multi-SIM intelligent Router with bandwidth aggregator</p>	should be shared NW	Terms & Conditions applicable as per RFP
203	J	20. EXTERNAL DIGITAL SIGNAGE SOLUTION (EDSS)	<p>Reputed ISI certified brands. The size of the External digital signage LED screen shall be advised by the bank for each such site. Size shall depend on the site, and it shall be minimum of 21 sq. ft.</p>	<p>In regards to size when you mention overall 21sq.ft Minimum - We would like to know what's the length you are expecting of the total board including Static and LED E.g. If LED Part is near by 7 Feet out if 10 Feet in length then the exact length deliverable in LED will be 7 Feet 3 Inches (2240 MM) due to minimum module size available</p>	Terms & Conditions applicable as per RFP

203	L	20. EXTERNAL DIGITAL SIGNAGE SOLUTION (EDSS)	To be able to integrate with the different systems of the Bank, such as Switch, ATM monitoring tool, etc., as per the Bank's requirement, at no extra cost to the Bank.	Integration with Different system of Banks that is `switch and ATM monitoring is not possible as there will be a OEM hardware as well as software clash here, although the led board will have a timer to switch off and on automatically and its on independent Internet network via SIM it doesn't not require to be integrated with banking system nor we recommend the same for safety reasons. Bank to Confirm.	Terms & Conditions applicable as per RFP
203	q	EXTERNAL DIGITAL SIGNAGE SOLUTION (EDSS)	Bidder shall attend and rectify the Break down / repair / replacement of EDSS call(s) registered by Bank / Bank's representative within 2 days. Any repair / replacement / rectification / implantation task under EDSS advised by the Bank should be completed by the bidder within 2 days of intimation. Penalty @ ₹ 500 per day from the 3rd day onwards	2 days only for non-part. For parts it should be 3 days for Metro and 5 days for Rural	<b>CORRIGENDUM:</b> Bidder shall attend and rectify the Break down / repair / replacement of EDSS call(s) registered by Bank / Bank's representative within <b>2 4</b> days. Any repair / replacement / rectification / implantation task under EDSS advised by the Bank should be completed by the bidder within <b>2 4</b> days of intimation. Penalty @ ₹ 500 per day from the <del>3rd</del> <b>5th</b> day onwards per non-complied call(s) will be levied.

			per non-complied call(s) will be levied.		
205	C	Lollipop Signage	Lollipop Signage	As per the image shared for Lollipop signage it is round. However the standard lollipop size is 2*2 square shape. Bank to confirm if we can go for the standard square shape.	Terms & Conditions applicable as per RFP
206	23	SPLIT AIR CONDITIONERS (INCLUDING PIPING)	1 Ton dual invert Split AC (White colour) with remote with 5 star rating, ISEER 4.5 and above. All weather AC (hot and cold) to be installed at places experiencing cold winters (less than 5-degree)	We request bank that "all weather AC" is not required in India.	Terms & Conditions applicable as per RFP

206	23	SPLIT AIR CONDITIONERS (INCLUDING PIPING)	1 Ton dual Inverter Split AC (white colour) with remote with 5 Star rating, ISEER 4.5 and above. All Weather AC (hot and cold) to be installed at places experiencing cold winters (less than 5-degree centigrade temperatures) especially in North & North east India.	Currently we do not have hot and cold model in 1T 5 star, Also pricing will be on a higher side as compared to the existing 1T 5-star regular model	Terms & Conditions applicable as per RFP
206	22 a	ACCESSORIES	Chair-1 Number good quality / branded plastic chairs with handles for Security guard;	Optional	Terms & Conditions applicable as per RFP
206	4.1.2 -22	ACCESSORIES	Chair-1 Number good quality / branded plastic chairs with handles for security guard	Most of the places security is not deployed, hence to be removed	Terms & Conditions applicable as per RFP
206	4.1.3	SPLIT Air Conditioner	TIMER - Timer Timer used should be 24-hour dial type day timer with manual adjustment for running the air conditioners	There will be no separate Timer along with the AC; the ACs will be connected to the DB which will have the inbuilt Timer.	Terms & Conditions applicable as per RFP

			alternately every 4 hours.		
207	23	Appendix E - Scope of Work SPLIT AIR CONDITIONERS (INCLUDING PIPING)	Stabilizer for AC:- Compact Stabiliser 4 KVA. ISI make or from ISO certified company-1 No for both the Acs	Would request the Bank to change this to 2 KVA Stabilizer to fulfil the requirement	Terms & Conditions applicable as per RFP
207	4.1.2 (Point 23)	Site Work Specifications	Stand for AC	What is the Application	Terms & Conditions applicable as per RFP
207	4.1.2 (Point 23) (b)	Site Work Specifications	Stabilizer	Why 2 stabiliser is required?	Terms & Conditions applicable as per RFP
207	4.1.2 (Point 23) (b)	Site Work Specifications	M.S Stand.	What is this for?	Terms & Conditions applicable as per RFP
209	28	Wall Mounted Sanitizer dispenser	Wall Mounted Sanitizer dispenser	Optional	Terms & Conditions applicable as per RFP

210	4.2	e-SURVEILLANCE SYSTEMs	(eSS) : Bidder to ensure that connectivity solution / technology should be capable of high-quality live view / live streaming of all CCTV cameras through dashboard / Mobile app as well as support daily backup of footages.	Footages are stored at local HDD for ES and daily back up is not part of standard solution.	Terms & Conditions applicable as per RFP. Clarification: Please refer page no. 213, para 14.
210	4.2	e-SURVEILLANCE SYSTEMs	Separate network connectivity to be provided for the e-surveillance system. The connectivity used for the ATM should NOT be used for e-surveillance system	Wanted to know Whether the Both ATM and E surveillance network can be differently routed through same/Common router /SDwan technology or access point.	Terms & Conditions applicable as per RFP
210	4.2	e-SURVEILLANCE SYSTEMs (eSS)	Separate network connectivity to be provided for the e-surveillance system. The connectivity used for the ATM should NOT be used for e-surveillance system	Whether the Both ATM and E surveillance network can be differently routed through same/Common router /SDwan technology or access point.	Terms & Conditions applicable as per RFP

210	4.2	e-SURVEILLANCE SYSTEMs (eSS)	4 e. hidden camera(s) focussing on cash slot of each machine to ascertain cash dispensation and collection of cash by the customer	Are 2 hidden pin hole camera re quired or is it one that focusses on cash dispensation?	Terms & Conditions applicable as per RFP
210	4.2	e-SURVEILLANCE SYSTEMs (eSS)		Bidder requests the bank to clarify if the QRT (Quick Response Team) is out of scope of the RFP as the RFP has no mention of it.	Terms & Conditions applicable as per RFP
210	4 (e)	e-SURVEILLANCE SYSTEMs (eSS)	hidden camera(s) focussing on cash slot of each machine to ascertain cash dispensation and collection of cash by the customer	Are 2 hidden pin hole camera re quired or is it one that focusses on cash dispensation?	Terms & Conditions applicable as per RFP
210	4.1.2 -28	Wall mounted sanitizer dispenser	In case of any mandate by IBA/RBI/Govt. of India/ State or District Govt./ any statutory body etc., Vendors to provide wall mounted sanitizers with Govt. approved sanitizer liquid/gel and maintain it, at no additional cost to the Bank	Not required in present scenario	Terms & Conditions applicable as per RFP

210	4.2 - 4 e	e-SURVEILLANCE SYSTEMs (eSS)	hidden camera(s) focussing on cash slot of each machine to ascertain cash dispensation and collection of cash by the customer.	We request bank to remove this clause as installing hidden camera for cash slot will not be feasible for Ess stand point. The bank has already procuring ATM with cash slot camera which will server the banks purpose.	Terms & Conditions applicable as per RFP
210	4.2 (5)	Appendix E - Scope of Work e-SURVEILLANCE SYSTEMs (eSS)	All Cameras should be IP Cameras with High Resolution (at least 3840 x 2160-pixel resolution or above) and should be able to record clear images and videos in all scenarios including dull light, no light at ATM site or the bright light from the background. While viewing the site in real time through CCTV surveillance from Command centre / dashboard / mobile app of the vendor, there should be no interruptions due to connectivity / Bandwidth related issues.	IP Camera - up to 4 MP (2688 x 1520) can fulfil the requirement, as the area required to be covered is ATM room, which are generally small in size.	<b>CORRIGENDUM:</b> All Cameras should be IP Cameras with High Resolution (at least <del>3840 x 2160</del> 2688 x 1520 pixel resolution or above) and should be able to record clear images and videos in all scenarios including dull light, no light at ATM site or the bright light from the background. While viewing the site in real time through CCTV surveillance from Command centre / dashboard / mobile app of the vendor, there should be no interruptions due to connectivity / Bandwidth related issues.



211	4.2	e-SURVEILLANCE SYSTEMs (eSS)	8) Detection of lingering or unauthorized activity for more than two minutes, motion-based monitoring 24x7x365 using video analytics. Additionally, monitoring using motion detectors through PIR (Passive Infrared) sensor from 8 PM to 8 AM.	Ticket creation for lobby loitering in 02 minutes will generate too large volume hence not advisable . Bidder recommend ticket creation between 10:00 PM to 06:00 AM for lobby movement for event more than 8 minutes	Terms & Conditions applicable as per RFP
211	4.2	e-SURVEILLANCE SYSTEMs (eSS)	To detect and deter a person wearing helmet, covering / masking the face, trying to carry out any unauthorized or suspicious activity. The command centre should warn the person to remove helmet, mask, etc.	Bidder confirms this will be covered by AI & no manual comand by monitoring desk.	Terms & Conditions applicable as per RFP
211	6	e-SURVEILLANCE SYSTEMs (eSS)	All machines at the ATM sites to have removal, vibration, contact and thermal sensors	Removal sensors are provided to machines at the ATM sites. Vibration and Thermal are for ATM machine only. The need of Vibration and Thermal for all machines are not necessary and it will increase cabling too.	Terms & Conditions applicable as per RFP

211	4.2 (6)	e-SURVEILLANCE SYSTEMs	All machines at the ATM sites to have removal, vibration, contact and thermal sensors.	we suggest Removal sensors are provided to machines at the ATM sites. Vibration and Thermal are for ATM machine only. The need of Vibration and Thermal for all machines are not necessary and it will increase cabling too.	Terms & Conditions applicable as per RFP
211	4.2.5	e-SURVEILLANCE SYSTEMs (eSS)	All Cameras should be IP Cameras with High Resolution (at least 3840 x 2160-pixel resolution or above) and should be able to record clear images and videos in all scenarios including dull light, no light at ATM site or the bright light from the background.	The proposed resolution will reduce the storage capacity. We request the resolution for the IP camera to 1920 x 1080-pixel or above.	<b>CORRIGENDUM:</b> All Cameras should be IP Cameras with High Resolution (at least <del>3840 x 2160</del> 2688 x 1520-pixel resolution or above) and should be able to record clear images and videos in all scenarios including dull light, no light at ATM site or the bright light from the background. While viewing the site in real time through CCTV surveillance from Command centre / dashboard / mobile app of the vendor, there should be no interruptions due to connectivity / Bandwidth related issues.

211	4.2.8	e-SURVEILLANCE SYSTEMs (eSS)	<p>Detection of lingering or unauthorized activity for more than two minutes, motion-based monitoring 24x7x365 using video analytics.</p> <p>Additionally, monitoring using motion detectors through PIR (Passive Infrared) sensor from 8 PM to 8 AM.</p>	<p>We request bank to consider motion detectors through PIR sensor from 10PM to 6AM</p>	<p>Terms &amp; Conditions applicable as per RFP</p>
211	4.2-5211		<p>5)All Cameras should be IP Cameras with High Resolution (at least 3840 x 2160-pixel resolution or above) and should be able to record clear images and videos in all scenarios including dull light, no light at ATM site or the bright light from the background. While viewing the site in real time through CCTV surveillance from Command centre / dashboard / mobile app of the vendor, there should be no interruptions</p>	<p>Footage sharing with such high resolution and size of single file would reach to 80-100MB and not feasible for sharing as it may impact the network bandwidth.We can provide a clear image and vidoes with the lesser resolutionlike 1028/720P . We would request bank to consider providing clear image and videos</p>	<p><b>CORRIGENDUM:</b>  All Cameras should be IP Cameras with High Resolution (at least <del>3840</del> <del>x 2160</del> 2688 x 1520 pixel resolution or above) and should be able to record clear images and videos in all scenarios including dull light, no light at ATM site or the bright light from the background. While viewing the site in real time through CCTV surveillance from Command centre / dashboard / mobile app of the vendor, there should be no interruptions due to connectivity / Bandwidth related issues.</p>

			due to connectivity / Bandwidth related issues.		
213	4.2	e-SURVEILLANCE SYSTEMs (eSS)	Vendor shall arrange to upload / provide CCTV / DVSS footage(s) to portal / dashboard / Bank, as per the TAT (3 Calendar Day) defined above wherever required by the GOI / Bank / Law enforcement agency(ies) / I4C (Indian CyberCrime	TAT for footage delivery should be 4 working days & external dependency to be considered for exclusion in performance rating	Terms & Conditions applicable as per RFP

			co-ordination centre) etc.		
213	16	Appendix E - Scope of Work e-SURVEILLANCE SYSTEMs (eSS)	Vendors to provide the facility (Web based as well as Mobile app based) for viewing & downloading the live footages to the authorised Bank officials / representative of Circles / CC / GITC, by selecting ATM ID. For viewing the RFP FOR TOM P-XVII 13,500 ATMs Page 214 of 421 stored images & footages, option should be provided by entering the ATM ID, Date & Time of	Opening the system to mobile networks may lead to vulnerabilities and security issues. Would suggest that the branch managers request the requisite footages from the ESS team and they would provide the same on-demand	Terms & Conditions applicable as per RFP

			images & video footages.		
213	4.2 - 14	e-SURVEILLANCE SYSTEMs (eSS)	Vendor to Store / preserve Images / Videos for Verification for minimum 180 days at centralized location / Cloud.	What about the local storage capacity of CCTV Camera and requesting bank to modify clause as cloud storage of Lobby Camera should be at cloud for 180 days at 1FPs. Reason for this modification is mainly due to unavailability of high upload streaming from 4G ISP vendors	Terms & Conditions applicable as per RFP

213	4.2 e-SURVEILLANCE SYSTEMS (eSS)		Vendors to provide the facility (Web based as well as Mobile app based) for viewing & downloading the live footages to the authorised Bank officials / representative of Circles / CC / GITC, by selecting ATM ID. For viewing the stored images & footages, option should be provided by entering the ATM ID, Date & Time of images & video footages.	In case this service is provided to the bank will there still be a requirement to submit footages?	Terms & Conditions applicable as per RFP
-----	----------------------------------	--	--	--	--

213	4.2-16		<p>16) Vendors to provide the facility (Web based as well as Mobile app based) for viewing &amp; downloading the live footages to the authorised Bank officials / representative of Circles / CC / GITC, by selecting ATM ID. For viewing the stored images &amp; footages, option should be provided by entering the ATM ID, Date &amp; Time of images &amp; video footages.</p>	<p>Viewing and downloading of Images and videos based on ATM ID using Web app is available. Viewing is available using our mobile app, Enabling Download features through mobile app would create security risks. So we would request bank to reconsider this .</p>	<p>Terms &amp; Conditions applicable as per RFP</p>
-----	--------	--	---	---	---



214	4.2	e-SURVEILLANCE SYSTEMs (eSS)	25. The offered system should have various reporting capabilities such as E-surveillance System down report, ATM wise alert reports, Ticket transaction reports, Mains Power Cut report, Chest Door open report, Hood open report (upper and down), Housekeeping Attendant report and CRA attendance report and connectivity / Link uptime report etc.	These can be provided only if the CRA and HK personnel activates the relevant switch	Terms & Conditions applicable as per RFP
214	19	Appendix E - Scope of Work e-SURVEILLANCE SYSTEMs (eSS)	Use of 2-Way Audio to deter the attempted crime and the system should be highly capable of clear voice / sound quality and there should be no disconnection even if the connectivity is lost with the command center	Incase of loss of connectivity to the Command Center, the 2-way communication will become inoperable till the time the connectivity is restored. Hence, we request Bank to re-evaluate the same.	Terms & Conditions applicable as per RFP

214	25	e-SURVEILLANCE SYSTEMs (eSS)	The offered system should have various reporting capabilities such as E-surveillance System down report, ATM wise alert reports, Ticket transaction reports, Mains Power Cut report, Chest Door open report, Hood open report (upper and down), Housekeeping Attendant report and CRA attendance report and connectivity / Link uptime report etc.	These can be provided only if the CRA and HK personnel activates the relevant switch	Terms & Conditions applicable as per RFP
215	4.2	e-SURVEILLANCE SYSTEMs (eSS)	c) The Bank may integrate the e-surveillance installed at Endpoint sites with its own e-surveillance dashboard / solution. The Vendors should cooperate with the integration conforming to Bank's IS policy at no additional cost to the Bank.	Integartion of system will depend on feasibility and devlopment will need commercial approval by bank	Terms & Conditions applicable as per RFP

215	28	e-SURVEILLANCE SYSTEMs (eSS)	e-Surveillance Systems (eSS) should be functional / operational 24x7x365. If any deficiency observed / found by Bank / Bank's representative, a penalty of Rs 2,000/= per instance per site shall be recovered from the Vendor.	We request bank to consider remove this penalty clause as bank has already cover penalty on footage case.	<b>CORRIGENDUM:</b> e-Surveillance Systems (eSS) should be functional / operational 24x7x365. If any deficiency observed / found by Bank / Bank's representative, a penalty of Rs <del>2,000/=</del> <b>1,000/=</b> per instance per site shall be recovered from the Vendor.
215	28	Site Implementation Services (SIS)	e-Surveillance Systems (eSS) should be functional / operational 24x7x365. If any deficiency observed / found by Bank / Bank's representative, a penalty of Rs 2,000/= per instance per site shall be recovered from the Vendor.	Stipulated penalty is too high. Request Bank to consider and reduce Penalty Rs 500/- per instance.	<b>CORRIGENDUM:</b> e-Surveillance Systems (eSS) should be functional / operational 24x7x365. If any deficiency observed / found by Bank / Bank's representative, a penalty of Rs <del>2,000/=</del> <b>1,000/=</b> per instance per site shall be recovered from the Vendor.

215	12)	Required Sensors and Devices: Appropriate actions to be taken whenever alerts are generated by the sensors-	28) e-Surveillance Systems (eSS) should be functional / operational 24x7x365. If any deficiency observed / found by Bank / Bank's representative, a penalty of Rs 2,000/= per instance per site shall be recovered from the Vendor.	eSurveillance Penalty - This is the service related issues and exclusion should be provided by Bank also Bidder requesting Bank to reduce this penalty to 100 per instance	<b>CORRIGENDUM:</b> e-Surveillance Systems (eSS) should be functional / operational 24x7x365. If any deficiency observed / found by Bank / Bank's representative, a penalty of Rs <del>2,000/=</del> 1,000/= per instance per site shall be recovered from the Vendor.
215	29( c)		The Bank may integrate the e-surveillance installed at Endpoint sites with its own e-surveillance dashboard / solution. The Vendors should co-operate with the integration conforming to Bank's IS policy at no additional cost to the Bank.	integration of E surveillance system with bank dashboard- is there any compatible make /model suggested	Terms & Conditions applicable as per RFP

216	4.2	e-SURVEILLANCE SYSTEMs (eSS)	<p>30. The Bank or bidder may require to:</p> <ul style="list-style-type: none"> <li>a) Shift Endpoints to new location;</li> <li>b) Add new machine(s) at existing location;</li> <li>c) Replace old ATM machine(s) with new one;</li> <li>d) Renovate ATM Site,</li> </ul> <p>In all the above mentioned cases, the bidder must Dismantle / Add / Replace / Shift / Reinstall the same / new equipment / sensors at existing / new location, as the case may be, without any cost to the Bank.</p>	Costing will be applicable if the count of sites for reinstallation and relocation is more	Terms & Conditions applicable as per RFP
216	4.2	e-SURVEILLANCE SYSTEMs (eSS)	<p>33. During the currency of the contract, the system should be upgraded at no extra cost to the bank. Any technological upgradation in CCTV, more specifically due to regulatory / administrative</p>	Yes if possible to upgrade using same equipment using firmware upgrade; replacement will entail costs	Terms & Conditions applicable as per RFP

			requirement, no extra cost to be charged to the bank.		
216	30	Site Implementation Services (SIS)	<p>The Bank or bidder may require to:</p> <ul style="list-style-type: none"> <li>a) Shift Endpoints to new location</li> <li>b) Add new machine(s) at existing location</li> <li>c) Replace old ATM machine(s) with new one</li> <li>d) Renovate ATM Site</li> </ul> <p>In all the above mentioned cases, the bidder must Dismantle / Add / Replace / Shift / Reinstall the same / new equipment / sensors at existing / new location, as the case may be, without any cost to the Bank.</p>	In case of Bank initiated relocations, the costs related to shifting, dismantling, De-installation, Re-installation should be reimbursed by the Bank on mutually agreed rate.	<b>CORRIGENDUM:</b> d) <del>Renovate</del> Refurbish / renew ATM Site

217	4.2	e-SURVEILLANCE SYSTEMs (eSS)	45. A notice prepared elegantly (as provided by the Bank under SIS creatives) to the effect that the site is under electronic surveillance shall be displayed at the entrance and inside the ATM room.	Bank to provide creatives before the start of the project	Terms & Conditions applicable as per RFP
217	41	Appendix E - Scope of Work e-SURVEILLANCE SYSTEMs (eSS)	An alert must be raised in case someone blocks or tampers with the cash dispenser / cash shutter of the ATM machine to manipulate the cash being dispensed by ATM machine. Whole activity should be recorded as a continuous video.	These activities are carried on in ways that it is difficult to generate Alerts. Would request the Bank for removal of this clause as it is practically not possible. Hence, we request Bank to re- evaluate the same.	<b>CORRIGENDUM:</b> <del>An alert must be raised in case someone blocks or tampers with the cash dispenser / cash shutter of the ATM machine to manipulate the cash being dispensed by ATM machine. Whole activity should be recorded as a continuous video.</del>
217	4.2 - 40	e-SURVEILLANCE SYSTEMs (eSS)	System should be capable of preventing the malware attack on the network / data / Command centre of the Vendor / e-Surveillance partner	Bidder to implement best of the security policy and assess the system through Cert-in empaneled agency for the prevention of Malware attack otherwise there is no measure of weather system is capable of preventing malware attack or not	Terms & Conditions applicable as per RFP

217	4.2 - 41	e-SURVEILLANCE SYSTEMs (eSS)	An alert must be raised in case someone blocks or tampers with the cash dispenser / cash shutter of the ATM machine to manipulate the cash being dispensed by ATM machine. Whole activity should be recorded as a continuous video.	We request bank to remove this clause as this is not feasible from Ess stand point. This was tried during SBI Phase-IV deployment and it was dropped by bank.	<b>CORRIGENDUM:</b> <del>An alert must be raised in case someone blocks or tampers with the cash dispenser / cash shutter of the ATM machine to manipulate the cash being dispensed by ATM machine. Whole activity should be recorded as a continuous video.</del>
217	4.2 - 44	e-SURVEILLANCE SYSTEMs (eSS)	To show the live location of the site on google map. Installation of a GPS device at the endpoint site which will provide the latitude and longitude of the site at real time, which will be useful for SBI Finder App / Websites.	Request Bank to delete this clause since more accurate let long details can be obtained through VSAT service provider instead of E-Surveillance	Terms & Conditions applicable as per RFP



217	4.2 e-SURVEILLANCE SYSTEMS (eSS) 41)		41) An alert must be raised in case someone blocks or tampers with the cash dispenser / cash shutter of the ATM machine to manipulate the cash being dispensed by ATM	As of now there is only one solution available in the market which is block shaft provided by OEM which can restrict the fraudster to insert object. Shutter and presenter are being damaged when fraudster insert the object forcefully despite of block shaft. Alert mechanism is not available currently.	<b>CORRIGENDUM:</b> <del>An alert must be raised in case someone blocks or tampers with the cash dispenser / cash shutter of the ATM machine to manipulate the cash being dispensed by ATM machine. Whole activity should be recorded as a continuous video.</del>
218	4.2	e-SURVEILLANCE SYSTEMS (eSS)	55 b. To monitor the status of Signage, Air Conditioners (AC) and Lightings in the ATM room and to control the same by switching off / on, remotely from the Command Centre, manually or automatically, as per schedule specified by respective local ATM teams. The Bank may use this solution for any other site control measures also.	a. This is a function of ATM Room; ATM Vendor to install smart meter whose output can be taken by us to provide power consumption report. Besides, it increases costs, increases installation time and has no real use for the Bank since you are bearing all the costs; high or low.	Terms & Conditions applicable as per RFP

218	4.2	e-SURVEILLANCE SYSTEMs (eSS)	55 C. The vendor should be able to identify if the AC is not switched on even after executing the 'switch on' command and it should be able to send SMS / e-mail / Mobile App alerts etc. to designated persons (of vendor) in case of such failures and ensure it is rectified at the earliest	ATM vendors have certified high voltage installers. We prefer that this is excluded from the RFP document by the bank.	Terms & Conditions applicable as per RFP
218	53	e-SURVEILLANCE SYSTEMs (eSS)	To keep a check on the health of the e-Surveillance equipment / sensors and if required, necessary steps to be taken to ensure that the same is replaced / repaired / rectified within a maximum period of 24 hours from the time of fault occurrence.	We request bank to consider 48 hours for rectification	Terms & Conditions applicable as per RFP
218	54	Appendix E - Scope of Work e-SURVEILLANCE SYSTEMs (eSS)	Vendor shall submit the Security Clearance Certificate of eSS from CERT-In empanelled Security Auditors annually	Please clarify whether the requirement is for Hardware or Software or full infrastructure of E-Surveillance Solution	<b>CORRIGENDUM:</b> Vendor shall submit the Security Clearance Certificate of <b>full infrastructure</b> of eSS from CERT-In empanelled Security Auditors annually.

219	4.2 - 56	e-SURVEILLANCE SYSTEMs (eSS)	Bidder shall provide high security software i.e., cloud hosting on reputed hosting services like AWS / Azure / Google etc. conforming to Bank's IS policy and Bank's Cloud Policy.	Please amend this clause and allow private cloud also instead of specific hosting services, and make cert-in mandatory for these services	Terms & Conditions applicable as per RFP
222	4.2.1	Templates of Reports to be provided by Vendor (Reports can be added/modified as and when required by Bank):-	8. Penalty Calculation Sheet	Penalty shouldn't be more than the Monthly Revenue	Terms & Conditions applicable as per RFP
223	4.3.1.2	4.3 Site Maintenance Services:	Wall Mounted Sanitizer dispenser: In case of any mandate by IBA/RBI/Govt. of India/ State or District Govt./ any statutory body etc., Vendors to provide wall mounted sanitizers with Govt. approved sanitizer liquid/gel and maintain it, at no additional cost to the Bank.	We would request Bank to remove this clause	Terms & Conditions applicable as per RFP

223	4.3.1.2	Wall Mounted Sanitizer dispenser: In case of any mandate by IBA/RBI/Govt. of India/ State or District Govt./ any statutory body etc., Vendors to provide wall mounted sanitizers with Govt. approved sanitizer liquid/gel and maintain it, at no additional cost to the Bank.	Wall Mounted Sanitizer dispenser: In case of any mandate by IBA/RBI/Govt. of India/ State or District Govt./ any statutory body etc., Vendors to provide wall mounted sanitizers with Govt. approved sanitizer liquid/gel and maintain it, at no additional cost to the Bank.	We would request Bank to remove this clause	Terms & Conditions applicable as per RFP
223	4.3.1.4	4.3 Site Maintenance Services:	Pest control / anti-rodent treatment shall be undertaken minimum once every quarter along with the preventive maintenance of the machines.	We would request to change this clause as " Pest control / anti-rodent treatment shall be undertaken minimum once every 6 months along with the preventive maintenance of the machines".	Terms & Conditions applicable as per RFP

223	4.3.1.4	Pest control / anti-rodent treatment shall be undertaken minimum once every quarter along with the preventive maintenance of the machines.	Pest control / anti-rodent treatment shall be undertaken minimum once every quarter along with the preventive maintenance of the machines.	We would request to change this clause as " Pest control / anti-rodent treatment shall be undertaken minimum once every 6 months along with the preventive maintenance of the machines".	Terms & Conditions applicable as per RFP
224	4.3.2.1	4.3 Site Maintenance Services:	Caretaker Services are not required under the scope of this RFP, however, Selected Vendors are required to provide caretaker services at no extra cost to the Bank in the emergency requirement or wherever the same is needed by the Law Enforcement agencies or the Bank.	Cost of caretaker services is very high. We would request Bank to pay additional charges for the caretaker services as per Central Govt minimum wages for the sites where ever Bank wants to have the caretaker services.	Terms & Conditions applicable as per RFP

224	4.3.2.1	Caretaker Services	Caretaker Services are not required under the scope of this RFP, however, Selected Vendors are required to provide caretaker services at no extra cost to the Bank in the emergency requirement or wherever the same is needed by the Law Enforcement agencies or the Bank.	The Bank needs to clarify whether Caretaker services are required as part of RFP or not? Such services would be only in selected sites. Hence it is not possible to factor the cost as part of commercials. We request the Bank to reimburse the cost of Caretaker Services (as per applicable minimum wages Act) plus preagreed management charges wherever applicable	Terms & Conditions applicable as per RFP
224	4.3.2.1	Caretaker Services	Caretaker Services are not required under the scope of this RFP, however, Selected Vendors are required to provide caretaker services at no extra cost to the Bank in the emergency requirement or wherever the same is needed by the Law Enforcement agencies or the Bank.	Request Bank to consider if any new regulatory is announced leading to a substantial increase in cost. Either Bank create a separate optional line item in commercial or provide the exact count of sites where caretaker will be required. It is challenging to factor any cost without knowing the count of sites	Terms & Conditions applicable as per RFP

224	4.3.2.1	<p>Caretaker Services are not required under the scope of this RFP, however, Selected Vendors are required to provide caretaker services at no extra cost to the Bank in the emergency requirement or wherever the same is needed by the Law Enforcement agencies or the Bank.</p>	<p>Caretaker Services are not required under the scope of this RFP, however, Selected Vendors are required to provide caretaker services at no extra cost to the Bank in the emergency requirement or wherever the same is needed by the Law Enforcement agencies or the Bank.</p>	<p>Cost of caretaker services is very high. We would request Bank to pay additional charges for the caretaker services as per Central Govt minimum wages for the sites where ever Bank wants to have the caretaker services.</p>	<p>Terms &amp; Conditions applicable as per RFP</p>
-----	---------	--	--	--	---

224	Appendix E	4.3.2.1	<p>Caretaker Services are not required under the scope of this RFP, however, Selected Vendors are required to provide caretaker services at no extra cost</p> <p>to the Bank in the emergency requirement or wherever the same is needed by the Law Enforcement agencies or the Bank.</p>	<p>Request the Bank to Delete this clause or make these services optional at Incremental price / On actuals as per the prevailing caretaker services charges( including all state / central / govt statutory and compliance requirements) as we cannot envisage how many caretakers and how many shifts these services would be required for any location.</p>	<p>Terms &amp; Conditions applicable as per RFP</p>
-----	------------	---------	---	--	---



226	4.4.8	Housekeeping Services (Optional Item)	All sites shall be cleaned minimum twice a day for Regular ATMs and thrice a day for VIP ATMs and report through Online Portal or Mobile Application. At high-transacting machines or during monsoon seasons (irrespective of Regular / VIP categories), the bidder may have to increase the number of cleaning schedules in a day (more than the minimum specified in this clause), in such a manner that the lobby is always maintained clean and tidy.	We request bank to consider twice cleaning for VIP site too. As twice cleaning is sufficient for any type of Site	Terms & Conditions applicable as per RFP
226	4.5.1i	Managed Services for Endpoint	“ATM Loss Liability Limit” means the maximum amount of Service Provider’s liability for an ATM Loss. The ATM Loss Liability Limit is Rs. 60,00,000/- (Rupees	The stipulated limit of Rs 60,00,000/- is high and beyond the maximum cash loading capacity in the ATM . We request Bank to modify it to Rs 40,00,000/-.	Terms & Conditions applicable as per RFP

			Sixty lacs only) per ATM.		
227	4.5	Managed Services for Endpoint	Vendor may have to take over existing sites from Bank's existing MS / BLA / TOM Vendors (in case the same does not belong to it already) to provide the Services as mentioned in this RFP. Vendor to ensure that all kind of up-to-date dues, statutory or otherwise, are paid by existing Vendor. Vendor to note that at any stage, Bank shall not be responsible of any such dues.	For the sites mandated by the Bank for the handover, the Bank will have to facilitate the handover of the site (incl but not limited to the lease assignment, electricity bills, etc) from the existing vendor to the new vendor. The Bank will need to direct the existing vendor to clear all dues pertaining to the site before the handover. We request the Bank to modify this condition accordingly	Terms & Conditions applicable as per RFP Clarification: Every vendor shall frnrish the information in BID FORM.

229	4.5.2	1	<p>maintenance service (response and resolution), round the clock throughout the year including Saturdays, Sundays and Holidays during the terms of contract on oral/ telephonic/ email/ SMS / Mobile Application or any other mode of communication by the Bank or through its own service personnel or any service provider or any monitoring system through its own expert service resource wherever the ATMs are installed irrespective of number of physical visits at the site / endpoint and without any additional cost to the Bank. The service shall be made available by Vendor as under</p>	<p>There should be Call Logged at our Helpdesk or first information to be share to our Helpdesk only</p>	<p>Terms &amp; Conditions applicable as per RFP</p>
-----	-------	---	---	--	---

229	4.5.2	IMPLEMENTATION AND POST IMPLEMENTATION SUPPORT	Vendor shall provide First Line Maintenance (FLM) including cash related faults and Second Line maintenance (SLM) for all machines, replacements and maintenance service (response and resolution), round the clock throughout the year including Saturdays, Sundays and Holidays during the terms of contract on oral/ telephonic/ email/ SMS / Mobile Application or any other mode of communication by the Bank or through its own service personnel or any service provider or any monitoring system through its own expert service resource wherever the ATMs are installed irrespective of number of physical visits at the site / endpoint and without	We request bank to remove this penalty clause as this is TOM and already bank has factor uptime penalty. The bidder will get financial impact due to no transaction during such period. This penalty will impact on bidder financial factor.	<p><b>CORRIGENDUM:</b></p> <table border="0"> <thead> <tr> <th>Category</th> <th>Resolution Time/ TAT</th> <th>Penalty</th> </tr> </thead> <tbody> <tr> <td>VIP ATMs</td> <td>2-4 Hours</td> <td>Irrespective of the population group/ category Rs <del>1,200</del> 500/- per endpoint per hour.</td> </tr> <tr> <td>Regular ATMs</td> <td>i. 4-6 Hours</td> <td>At Metro, Urban and Semi-urban locations</td> </tr> <tr> <td></td> <td>ii. 6-8 Hours</td> <td>At Rural locations Rs <del>1,000</del> 200/- per endpoint per hour.</td> </tr> </tbody> </table> <p>The Bank has the discretion of classifying the ATMs as VIP or Regular subject to review.</p>	Category	Resolution Time/ TAT	Penalty	VIP ATMs	2-4 Hours	Irrespective of the population group/ category Rs <del>1,200</del> 500/- per endpoint per hour.	Regular ATMs	i. 4-6 Hours	At Metro, Urban and Semi-urban locations		ii. 6-8 Hours	At Rural locations Rs <del>1,000</del> 200/- per endpoint per hour.
Category	Resolution Time/ TAT	Penalty															
VIP ATMs	2-4 Hours	Irrespective of the population group/ category Rs <del>1,200</del> 500/- per endpoint per hour.															
Regular ATMs	i. 4-6 Hours	At Metro, Urban and Semi-urban locations															
	ii. 6-8 Hours	At Rural locations Rs <del>1,000</del> 200/- per endpoint per hour.															

		<p>any additional cost to the Bank. The service shall be made available by Vendor as under:</p>		
--	--	---	--	--

230	4.5.2	-	Regular ATMs, 4 Hours: At Metro, Urban and Semi-urban locations. Rs 1,000/- per endpoint per hour.	Recommending to change it to Rs. 200 Per hour or Rs. 1000 per day	<p><b>CORRIGENDUM:</b>  Category Resolution Time/  TAT Penalty  VIP ATMs <del>2</del> 4 Hours: Irrespective of the population group/ category Rs <del>1,200</del> 500/- per endpoint per hour.</p> <p>Regular ATMs i. 4- 6 Hours: At Metro, Urban and Semi-urban locations</p> <p>ii. <del>6</del> 8 Hours: At Rural locations Rs <del>1,000</del> 200/- per endpoint per hour. The Bank has the discretion of classifying the ATMs as VIP or Regular subject to review.</p>
230	4.5.2	IMPLEMENTATION AND POST IMPLEMENTATION SUPPORT	VIP ATM 2 Hours: Irrespective of the population group/ category. Rs 1,200/- per endpoint per hour.	Recommending to change it to Rs. 500 Per hour or Rs. 1220 per day	<p><b>CORRIGENDUM:</b>  Category Resolution Time/  TAT Penalty  VIP ATMs <del>2</del> 4 Hours: Irrespective of the population group/ category Rs <del>1,200</del> 500/- per endpoint per hour.</p> <p>Regular ATMs i. 4- 6 Hours: At Metro, Urban and Semi-urban locations</p> <p>ii. <del>6</del> 8 Hours: At Rural locations Rs <del>1,000</del> 200/- per endpoint per hour. The Bank has the discretion of classifying the ATMs as VIP or Regular subject to review.</p>

230	4.5.2	IMPLEMENTATION AND POST IMPLEMENTATION SUPPORT	<p>Category Resolution Time/ TAT Penalty</p> <p>VIP ATMs 2 Hours: Irrespective of the population group/ category Rs 1,200/- per endpoint per hour.</p> <p>Regular ATMs i. 4 Hours: At Metro, Urban and Semi-urban locations</p> <p>ii. 6 Hours: At Rural locations Rs 1,000/- per endpoint per hour.</p>	<p>Bank to consider removing this clause as it is a duplicate penalty since the penalties for downtime is also considered in separate clause</p>	<p><b>CORRIGENDUM:</b></p> <table border="0"> <thead> <tr> <th>Category TAT</th> <th>Resolution Time/ Penalty</th> </tr> </thead> <tbody> <tr> <td>VIP ATMs <del>2</del> 4 Hours:</td> <td>Irrespective of the population group/ category Rs <del>1,200</del> 500/- per endpoint per hour.</td> </tr> <tr> <td>Regular ATMs (i) 4- 6 Hours:</td> <td>At Metro, Urban and Semi-urban locations</td> </tr> <tr> <td>(ii) <del>6</del> 8 Hours:</td> <td>At Rural locations Rs <del>1,000</del> 200/- per endpoint per hour.</td> </tr> </tbody> </table> <p>The Bank has the discretion of classifying the ATMs as VIP or Regular subject to review.</p>	Category TAT	Resolution Time/ Penalty	VIP ATMs <del>2</del> 4 Hours:	Irrespective of the population group/ category Rs <del>1,200</del> 500/- per endpoint per hour.	Regular ATMs (i) 4- 6 Hours:	At Metro, Urban and Semi-urban locations	(ii) <del>6</del> 8 Hours:	At Rural locations Rs <del>1,000</del> 200/- per endpoint per hour.
Category TAT	Resolution Time/ Penalty												
VIP ATMs <del>2</del> 4 Hours:	Irrespective of the population group/ category Rs <del>1,200</del> 500/- per endpoint per hour.												
Regular ATMs (i) 4- 6 Hours:	At Metro, Urban and Semi-urban locations												
(ii) <del>6</del> 8 Hours:	At Rural locations Rs <del>1,000</del> 200/- per endpoint per hour.												

230	4.5.2	IMPLEMENTATION AND POST IMPLEMENTATION SUPPORT	<p>VIP ATMs 2 Hours: Irrespective of the population group/ category Rs 1,200/- per endpoint per hour.</p> <p>Regular ATMs i. 4 Hours: At Metro, Urban and Semi-urban locations ii. 6 Hours: At Rural locations Rs 1,000/- per endpoint per hour.</p> <p>The Bank has the discretion of classifying the ATMs as VIP or Regular subject to review.</p>	<p>The Penalty amount is too high, Bidder requesting Bank to re-looked the TATs and consider 6 Hours for M/U/S and 12 Hours for Rural locations</p>	<p><b>CORRIGENDUM:</b></p> <table border="0"> <tr> <td>Category</td> <td>Resolution Time/ TAT</td> <td>Penalty</td> </tr> </table> <p>VIP ATMs <del>2</del> 4 Hours: Irrespective of the population group/ category Rs <del>1,200</del> 500/- per endpoint per hour.</p> <p>Regular ATMs i. 4- 6 Hours: At Metro, Urban and Semi-urban locations</p> <p>ii. 6 8 Hours: At Rural locations Rs <del>1,000</del> 200/- per endpoint per hour.</p> <p>The Bank has the discretion of classifying the ATMs as VIP or Regular subject to review.</p>	Category	Resolution Time/ TAT	Penalty
Category	Resolution Time/ TAT	Penalty						
230	4.5.2 - 1	IMPLEMENTATION AND POST IMPLEMENTATION SUPPORT	<p>Category Resolution Time/ TAT Penalty</p> <p>VIP ATMs 2 Hours: Irrespective of the population group/ category Rs 1,200/- per endpoint per hour.</p> <p>Regular ATMs i. 4 Hours: At Metro, Urban and Semi-urban locations ii. 6 Hours: At Rural</p>	<p>Request Bank to review as there are multiple penalties and the said penalties are already covered under other SLA parts.</p>	<p><b>CORRIGENDUM:</b></p> <table border="0"> <tr> <td>Category</td> <td>Resolution Time/ TAT</td> <td>Penalty</td> </tr> </table> <p>VIP ATMs <del>2</del> 4 Hours: Irrespective of the population group/ category Rs <del>1,200</del> 500/- per endpoint per hour.</p> <p>Regular ATMs i. 4- 6 Hours: At Metro, Urban and Semi-urban locations</p> <p>ii. 6 8 Hours: At Rural locations Rs <del>1,000</del> 200/- per endpoint per hour.</p> <p>The Bank has the discretion of</p>	Category	Resolution Time/ TAT	Penalty
Category	Resolution Time/ TAT	Penalty						



			locations Rs 1,000/- per endpoint per hour.		classifying the ATMs as VIP or Regular subject to review.
230	4.5.2 (1)	IMPLEMENTATION AND POST IMPLEMENTATION SUPPORT	Resolution time and Penalty: VIP ATM TAT : 2 Hours : Rs 1200 per hr  Regular ATM TAT : 4 Hours : Metro / Urban / Semi Urban : Rs 1000 per hr  Rural ATM TAT : 6 Hours : Rs 1000 per hr	The proposed penalty is too high and unreasonable. Request Bank to consider as follows :  VIP ATM TAT : 2 Hours : Rs 200 per hr  Regular ATM TAT : 4 Hours : Metro / Urban : Rs 100 per hr  Semi Urban & Rural ATM TAT : 6 Hours : Rs 50 per hr	<b>CORRIGENDUM:</b> Category Resolution Time/ TAT Penalty VIP ATMs <del>2</del> 4 Hours: Irrespective of the population group/ category Rs <del>1,200</del> 500/- per endpoint per hour.  Regular ATMs i. 4- 6 Hours: At Metro, Urban and Semi-urban locations  ii. 6 8 Hours: At Rural locations Rs <del>1,000</del> 200/- per endpoint per hour. The Bank has the discretion of classifying the ATMs as VIP or Regular subject to review.

230	4.5.2- 1	4.5.2 IMPLEMENTATION AND POST IMPLEMENTATION SUPPORT	Resolution time/ TAT penalties: VIP ATMs- Resolutiom time of 2hrs- Penalty of Rs 1,200/- per endpoint per hour. Regular ATMs- Resolution time of 4hrs at Metro, Urban and Semiurban and resolution time of 6hrs for Rural location- Penalty of Rs 1,000/- per endpoint per hour.	This penalty is over and above the Uptime penalties and these penalties are very high. We would request Bank to remove this penalty clause	<p><b>CORRIGENDUM:</b></p> <table border="0"> <thead> <tr> <th>Category</th> <th>Resolution Time/ TAT</th> <th>Penalty</th> </tr> </thead> <tbody> <tr> <td>VIP ATMs</td> <td>2- 4 Hours</td> <td>Irrespective of the population group/ category Rs <del>1,200</del> 500/- per endpoint per hour.</td> </tr> <tr> <td>Regular ATMs</td> <td>i. 4- 6 Hours</td> <td>At Metro, Urban and Semi-urban locations</td> </tr> <tr> <td></td> <td>ii. 6- 8 Hours</td> <td>At Rural locations Rs <del>1,000</del> 200/- per endpoint per hour.</td> </tr> </tbody> </table> <p>The Bank has the discretion of classifying the ATMs as VIP or Regular subject to review.</p>	Category	Resolution Time/ TAT	Penalty	VIP ATMs	2- 4 Hours	Irrespective of the population group/ category Rs <del>1,200</del> 500/- per endpoint per hour.	Regular ATMs	i. 4- 6 Hours	At Metro, Urban and Semi-urban locations		ii. 6- 8 Hours	At Rural locations Rs <del>1,000</del> 200/- per endpoint per hour.
Category	Resolution Time/ TAT	Penalty															
VIP ATMs	2- 4 Hours	Irrespective of the population group/ category Rs <del>1,200</del> 500/- per endpoint per hour.															
Regular ATMs	i. 4- 6 Hours	At Metro, Urban and Semi-urban locations															
	ii. 6- 8 Hours	At Rural locations Rs <del>1,000</del> 200/- per endpoint per hour.															

230	4.5.2- 1	<p>Resolution time/ TAT penalties: VIP ATMs- Resolution time of 2hrs- Penalty of Rs 1,200/- per endpoint per hour. Regular ATMs- Resolution time of 4hrs at Metro, Urban and Semiurban and resolution time of 6hrs for Rural location- Penalty of Rs 1,000/- per endpoint per hour.</p>	<p>Resolution time/ TAT penalties: VIP ATMs- Resolution time of 2hrs- Penalty of Rs 1,200/- per endpoint per hour. Regular ATMs- Resolution time of 4hrs at Metro, Urban and Semiurban and resolution time of 6hrs for Rural location- Penalty of Rs 1,000/- per endpoint per hour.</p>	<p>This penalty is over and above the Uptime penalties and these penalties are very high. We would request Bank to remove this penalty clause</p>	<p><b>CORRIGENDUM:</b></p> <table border="1"> <thead> <tr> <th>Category</th> <th>Resolution Time/ TAT</th> <th>Penalty</th> </tr> </thead> <tbody> <tr> <td>VIP ATMs</td> <td>2- 4 Hours</td> <td>Irrespective of the population group/ category Rs <del>1,200</del> 500/- per endpoint per hour.</td> </tr> <tr> <td>Regular ATMs</td> <td>i. 4- 6 Hours</td> <td>At Metro, Urban and Semi-urban locations</td> </tr> <tr> <td></td> <td>ii. 6- 8 Hours</td> <td>At Rural locations Rs <del>1,000</del> 200/- per endpoint per hour.</td> </tr> </tbody> </table> <p>The Bank has the discretion of classifying the ATMs as VIP or Regular subject to review.</p>	Category	Resolution Time/ TAT	Penalty	VIP ATMs	2- 4 Hours	Irrespective of the population group/ category Rs <del>1,200</del> 500/- per endpoint per hour.	Regular ATMs	i. 4- 6 Hours	At Metro, Urban and Semi-urban locations		ii. 6- 8 Hours	At Rural locations Rs <del>1,000</del> 200/- per endpoint per hour.
Category	Resolution Time/ TAT	Penalty															
VIP ATMs	2- 4 Hours	Irrespective of the population group/ category Rs <del>1,200</del> 500/- per endpoint per hour.															
Regular ATMs	i. 4- 6 Hours	At Metro, Urban and Semi-urban locations															
	ii. 6- 8 Hours	At Rural locations Rs <del>1,000</del> 200/- per endpoint per hour.															

230		Resolution TAT ( FLM & SLM )	For VIP sites the Resolution TAT is 2 Hours and 4 to 6 hours for the rest of the locations.	There is per incident hourly penalty of 1,000 and above ( if TAT Not met ) . In present condition it will be difficult to meet this on every occasion hence request Bank to dilute and put the clause saying CRA to meet the TAT 80% of the time on monthly basis and if not met Rs 250 as the Penalty.	<p><b>CORRIGENDUM:</b></p> <p>Category Resolution Time/ TAT Penalty</p> <p>VIP ATMs <del>2</del> 4 Hours: Irrespective of the population group/ category Rs <del>1,200</del> 500/- per endpoint per hour.</p> <p>Regular ATMs i. 4- 6 Hours: At Metro, Urban and Semi-urban locations</p> <p>ii. 6 8 Hours: At Rural locations Rs <del>1,000</del> 200/- per endpoint per hour. The Bank has the discretion of classifying the ATMs as VIP or Regular subject to review.</p>
231	ii	-	The Bank's re-testing charges of Rs.20 lakh per machine should be borne by the bidder	This should be borne by the Bank	Terms & Conditions applicable as per RFP

232	4.5.2	IMPLEMENTATION AND POST IMPLEMENTATION SUPPORT	Vendor shall extend all support required by the Bank to integrate with Bank's 'Online Monitoring Solution (OMS)' and Mobile Apps when Bank requires integration. If Bank decides not to integrate, the vendor should use the Bank's Monitoring Tools (OMS, ESQ etc.). The Bank will provide login credentials to authorized personnel.	The bidder can monitor & manage the ATM network efficiently & effectively when Bidder is allowed to use its monitoring tool. The bidder requests the bank to either provide the monitoring feed or intergate with ESQ. When the feed is provided or integrated with bidder's monitoring tool bidder can not act fast on the ATM health messages but also utilizing its internal functions/capabilities for automated dispatches, remote commands etc.	Terms & Conditions applicable as per RFP
-----	-------	--	--	---	--

232	Appendix E	4.5.2 j	<p>To provide the complete details with escalation matrix for reporting issues along with URL where the call is required to be logged. Vendor shall extend all support required by the Bank to integrate with Bank's 'Online Monitoring Solution (OMS)' and Mobile Apps when Bank requires integration. If Bank decides not to integrate, the vendor should use the Bank's Monitoring Tools (OMS, ESQ etc.). The Bank will provide login credentials to authorized personnel.</p>	<p>Bank is requesting for either integration or monitoring via ESQ or OMS tools.</p>	<p>Terms &amp; Conditions applicable as per RFP</p>
-----	------------	---------	---	--	---

232	Appendix E	h	<p>Vendor to arrange for services like DNS (Domain Name System) setting, IP address changes, MAC address changes, Message Authentication Code changes, TLS changes, TMK changes, changing currency cassettes configuration, cassettes calibration, changing combination lock setting or any other activities which cannot be performed by Centralized solutions as and when requested by Bank without any additional cost to the Bank.</p>	<p>Request Bank to keep these out of scope activities as we cannot envisage no. of times these activities can come up as these have commercial implication</p>	<p>Terms &amp; Conditions applicable as per RFP</p>
-----	------------	---	--	--	---

233	iv	n. Preventive Maintenance (PM):	Such visits could also be covered in visits for trouble shooting provided preventive maintenance is also done. Vendor should submit to the Bank a report as per requirement given in Online Portal or alternatively confirmed through the Web Portal. If required by Bank, Vendors should also use the Bank's Mobile App (of OMS) to fill the below checklist and submit it in the Mobile App. Access to Mobile App shall be provided to authorized personnel of the vendors. The vendor should invariably use Field call report (FCR) in Online monitoring System for uploading of preventive maintenance.	OEMs have their own setup. Adding one more app or tool is not feasible	Terms & Conditions applicable as per RFP
-----	----	---------------------------------	---	--	--



233	vi	n. Preventive Maintenance (PM):	PM should also be done for all the allied equipment like ACs, UPS, batteries with minimum 8 hours backup, eSS. Digital Signages etc. in the ATM Lobby once in every calendar quarter	PM not required for UPS and Vsat	Terms & Conditions applicable as per RFP
234	4.5.2	Vi	Using a vacuum cleaner, vacuum all internal surfaces including all modules	Request for clarity	Terms & Conditions applicable as per RFP
234	N VI	Preventive Maintenance (PM):	Mentioned checklist	We request bank to allow the selected bidder to use there stander PM format that will cover all the mentioned item in the RFP	Terms & Conditions applicable as per RFP
236	P	Preventive Maintenance (PM):	During the entire Contract Period and extension thereof, any PC Core, hardware upgrade required (like RAM, hard disk etc.) would be without any cost to the Bank.	Any future upgrade to be done at mutually agreed commercials	Terms & Conditions applicable as per RFP
238	nn	Preventive Maintenance (PM):	(a) checking camera status, image capturing and data storage at every	We request bank clarity on our understanding that the checking of storage of image is at ATM end only.	Terms & Conditions applicable as per RFP

			preventive maintenance of ATMs		
239	4.5.4	Replenishment of Consumables	Vendor to supply and replenish consumables such as paper roll, printer ribbons, Vendor shall replenish inkjet cartridge, essential consumables to ensure uninterrupted ENDPOINT operation as necessary without limitation on quantity	We request bank to consider Consumables shall be supplied basis last 3 months transaction hits.	Terms & Conditions applicable as per RFP

240	4.5.5 - C	Appendix E - Scope of Work MANAGEMENT CENTRE ACTIVITIES	<b>Remote Monitoring:</b> i. Remotely poll devices at intervals that detect problems immediately on occurrence. ii. Detect events that exceed set thresholds. iii. Use Simple Network Management Protocol (SNMP) for polling, wherever SNMP cards are provided for UPS and necessary feed is received. iv. Use reliable, dedicated IP connection with backup. v. Endpoint/ATM cash forecasting. Daily order recommendation vi. Potential cash out/cash full warning for endpoint vii. Centralized monitoring and control over access to endpoint and safes	As per Network Service Provider 2 - We understand this polling will be done from E-surveillance and digital signage network and not through ATM network. Please confirm	Terms & Conditions applicable as per RFP
-----	-----------	---	---	---	--

240	C	Remote monitoring	Use Simple Network Management Protocol (SNMP) for polling, wherever SNMP cards are provided for UPS and necessary feed is received.	We understand this polling will be done from E-surveillance and digital signage network and not through ATM network. Please confirm	Terms & Conditions applicable as per RFP
240	Remote monitoring -C	Point no iii	Use Simple Network Management Protocol (SNMP) for polling, wherever SNMP cards are provided for UPS and necessary feed is received.	We understand this polling will be done from E-surveillance and digital signage network and not through ATM network. Please confirm	Terms & Conditions applicable as per RFP
240	Remote monitoring -C	Use Simple Network Management Protocol (SNMP) for polling, wherever SNMP cards are provided for UPS and necessary feed is received.	Use Simple Network Management Protocol (SNMP) for polling, wherever SNMP cards are provided for UPS and necessary feed is received.	We understand this polling will be done from E-surveillance and digital signage network and not through ATM network. Please confirm	Terms & Conditions applicable as per RFP

240		Remote monitoring -C	Use Simple Network Management Protocol (SNMP) for polling, wherever SNMP cards are provided for UPS and necessary feed is received.	We understand this polling will be done from E-surveillance and digital signage network and not through ATM network. Please confirm	Terms & Conditions applicable as per RFP
241	4.5.5 - I - vii. (PAGE 241 / 242)	MANAGEMENT CENTRE ACTIVITIES:	There shall be no exclusion to availability, except force majeure cases like flood, earthquake, natural calamities and vandalism cases etc. as mentioned under the "Force Majeure" clause of this RFP.	Request Bank to include other factors in exclusion criteria, such as accessibility, MHA , etc..	Terms & Conditions applicable as per RFP
241	4.5.5 F	Appendix-E	Intimation to Bank within 3 minutes of fault occurrence.	Today before down call ticket generation 30 mins are given for settling the fluctuation. 3 mins is too a less time for finalizing fault.	Terms & Conditions applicable as per RFP
241	4.5.5 MANAGEMEN T CENTRE ACTIVITIES:	F. Reporting:	Consolidation of settlement and reconciliation reports.	Request Bank to clarify the detailed recon scope	Terms & Conditions applicable as per RFP
241	H i	Response Time	Intimation to Bank within 3 minutes of fault occurrence.	Minimum 15 Minutes	Terms & Conditions applicable as per RFP

241	H.	Response Time	<p>i. Intimation to Bank within 3 minutes of fault occurrence.</p> <p>ii. Initiation of remedial action within 3 minutes from occurrence.</p>	This feature can be evaluated only if the bidder's monitoring tool is used.	Terms & Conditions applicable as per RFP
242	J.	Central Helpdesk at Management Centre	iv. The expected time of resolution should be average 3 minutes per call which are of routine nature.	Such resolution time is not practically achievable, Bidder request Bank to provide more clarity and remove this clause	Terms & Conditions applicable as per RFP
242	4.5.5 I(Vi)	Appendix-E	<p>Availability of VIP end Poin-98%</p> <p>Availability of Regular Endpoint 96%</p>	<p>1. The comms down due to Network should be excluded from this as these are not in CMS control.</p> <p>2. Machines down due to Bank instruction related activity as DC-DR shifting/ encryption should not be included in down time.</p>	<p><b>CORRIGENDUM:</b></p> <p>vi. All machines/endpoints of the Bank will be categorized in 2 types and maintain the availability mentioned there against: Category Minimum targeted Uptime/Availability per month</p> <p>VIP-endpoints 98%</p> <p>Regular endpoints <del>96%</del> 95%</p>

242	4.5.5.1.vii, viii	Availability of endpoints	<p>Category &amp; Uptime Target VIP- endpoints- 98% Regular endpoints - 95%</p> <p>There shall be no exclusion to availability, except force majeure cases like flood, earthquake, natural calamities and vandalism cases etc. as mentioned under the "Force Majeure" clause of this RFP.</p>	<p>Exclusion Required as per MHA Guideline for non Accessible Hours, Bank, OEM Pendency cases &amp; any reason not attributable to MS service provider.</p> <p>Also, downtime due to Bank's dependency to be considered in exclusions</p>	<p><b>CORRIGENDUM:</b> vi. All machines/endpoints of the Bank will be categorized in 2 types and maintain the availability mentioned there against: Category Minimum targeted Uptime/Availability per month VIP-endpoints 98% Regular endpoints <del>96%</del> <b>95%</b></p>
242	I. vii	Availability of end-points	vii. There shall be no exclusion to availability, except force majeure cases like flood, earthquake, natural calamities and vandalism cases etc. as mentioned under the "Force Majeure" clause of this RFP.	<p>Add the below in the exclusions - Bank dependency for access to machine, cash availability Downtime caused by implementation of MVS, encryption patch or any other software requested by the bank Downtime during the loading of cash</p>	Terms & Conditions applicable as per RFP

242	I.	Availability of endpoints:	vi. All machines/endpoints of the Bank will be categorized in 2 types and maintain the availability mentioned there against: Category Minimum targeted Uptime/Availability per month VIP-endpoints 98% Regular endpoints 96%	Bidder here by request Bank to consider the below exclusions for the factors which are beyond MSP control: <ul style="list-style-type: none"> <li>• Supervisory mode (up to 10Hrs per month for FLM, SLM, Maintenance &amp; EOD activities)</li> <li>• In ability of bank's third party vendor to support or meet the SLA</li> <li>• Site not accessible for ATM servicing due to timing/access restrictions</li> <li>• Any downtime beyond the backup hours supported by UPS batteries.</li> <li>• Any ATM being shutdown on daily basis on evening hrs</li> <li>• Downtime due to Software/MVS &amp; Other scheduled maintenance calls</li> <li>• Any Third party component failure where replacement required,</li> <li>• Power failure</li> <li>• software loading, MVS/Solid core issues.</li> <li>• Switch activity/failure,</li> <li>• Access availability issues</li> <li>• Downtime post operating hours as per the guidelines</li> <li>• Actual downtime due to cash out on account of delayed cash</li> </ul>	<b>CORRIGENDUM:</b> vi. All machines/endpoints of the Bank will be categorized in 2 types and maintain the availability mentioned there against: Category Minimum targeted Uptime/Availability per month VIP-endpoints 98% Regular endpoints <del>96%</del> 95%
-----	----	----------------------------	---	--	---





supply i.e., later than 12PM or non-supply of the cash by the Bank

- Events of Force Majeure (Instances of force majeure, Vandalism and delays due to strikes, Bandh, Hartal, Political instability in the region (in such cases, the vendor shall inform and seek Bank's confirmation of its non-liability for penalty)
- Core Banking solution host outages
- Any downtime which are not attributable to MSP
- Any other cause attributable to Bank's infrastructure
- Faults which are not reported through online Switch Feed. Bank Switch doesn't provide feeds for monitoring to Partner. Partner will intimate such instances within a reasonable time (20 min).
- Delay by the Bank in providing Terminal Master (TM) keys beyond 30 minutes from the partner engineer visits the site for site installation/servicing of CDs
- The cash out instances and resultant CD downtime will be excluded from the calculation of uptime if the ATM fit

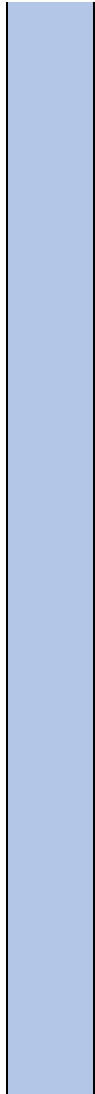

currency not provided by Bank to CITs

- Downtime due to NFS/issuing Bank network unavailability including but not limited to lease lines/LAN, host connectivity with the Switch or any other devices or due to the downtime of existing ATM leased line downtimes.
- Downtime due to scheduled maintenance of Bank's switch
- Downtime due to unavoidable delays for service personnel to reach the site on account of unavailability of public transport, road blocks, strikes, riots or natural calamities etc.,
- Problems caused in rural areas or chronic power deficit area due to power cuts and improper switching OFF/ON of CD after the restoration of power
- Downtime due to robbery attempt/vandalism at the site
- Downtime caused due to any fraudulent activity which requires investigation.

242	vi	Minimum targeted Uptime/Availability per month	VIP-endpoints-98, Regular endpoints-96	this uptime should be calculated after exclusion of response and resolution mentioned in RFP. Bank to configure ESQ to exclude response and resolution time for each down ticket in a month	<b>CORRIGENDUM:</b> vi. All machines/endpoints of the Bank will be categorized in 2 types and maintain the availability mentioned there against: Category Minimum targeted Uptime/Availability per month VIP-endpoints 98% Regular endpoints <del>96%</del> 95%
247	4.5.7	FIRST LINE MAINTENANCE (FLM) SERVICES	iv. Site maintenance, maintaining environmental conditions and cleaning work as mentioned above in Scope of Work.	This is a part of Housekeepig/SRM services and should not be clubbed under the head of FLM services	<b>CORRIGENDUM:</b> iv. Site maintenance, maintaining environmental conditions <del>etc. and cleaning work</del> as mentioned above in Scope of Work.
248	4.5.7 FIRST LINE MAINTENANCE (FLM) SERVICES		viii. Taking backup of camera images (of all cameras mentioned in Technical Specifications) on monthly basis on a suitable backup media and handing over the same to the controlling office.	The backup is taken by the ATM itself. In case another backup needs to be taken from the ATMs then that adds to the complication. Request the bank to remove this requirement since bank can pull the images from the ATMs as and when required.	<b>CORRIGENDUM:</b> Taking backup of camera image(s) / <del>footage(s)</del> (of all cameras mentioned in Technical Specifications) <b>as and when Software upload / reload, upgradation etc. shall be done by the bidder. on monthly basis on a suitable backup media and handing over the same to the controlling office.</b>

248	4.5.7 FIRST LINE MAINTENANCE (FLM) SERVICES		xiv. Vendor should provide FLM services on 24 X 7 X 365 basis.	24X7 is not possible as there are restriction at night.	Terms & Conditions applicable as per RFP
248	4.5.7	FIRST LINE MAINTENANCE (FLM) SERVICES	xiv. Vendor should provide FLM services on 24 X 7 X 365 basis.	<p>Bidder here by Request to Consider the restrictions Timing for FLM Attendance, Travel Restrictions :</p> <p>Metro &amp; Urban - 8 pm to 8 am Rural &amp; Semi Urban - 6 pm to 8 am</p> <p>For Cassette Swap Sites - FLM (Bottom Hatch) &amp; SLM Will be attended alongwith Cash Loading activity</p>	Terms & Conditions applicable as per RFP

248	4.5.7 FIRST LINE MAINTENANCE (FLM) SERVICES	FIRST LINE MAINTENANCE (FLM) SERVICES	<p>viii. Taking backup of camera images (of all cameras mentioned in Technical Specifications) on monthly basis on a suitable backup media and handing over the same to the controlling office.</p> <p>ix. Maintaining proper register of the backup taken for DVSS with acknowledgement from Controlling Office and handover of backup to Controlling Office.</p>	This is a part of EJ/DVSS services and should not be clubbed under the head of FLM services	<p><b>CORRIGENDUM:</b> viii.Taking backup of camera image(s) / <b>footage(s)</b> (of all cameras mentioned in Technical Specifications) <b>as and when Software upload / reload, upgradation etc. shall be done by the bidder.</b> <del>on monthly basis on a suitable backup media and handing over the same to the controlling office.</del></p> <p>ix. Maintaining proper register of the backup taken for DVSS with acknowledgement from Controlling Office, <b>if any</b> and handover of backup to Controlling Office.</p>
248	4.5.7.xiii	FIRST LINE MAINTENANCE (FLM) SERVICES	FLM calls related to bottom hatch of the Endpoint that requires opening of Endpoint safe / vault shall be attended by Vendor appointed CIT.	Request Bank to align CRA services as per the MHA guidelines	Terms & Conditions applicable as per RFP
248	xiv	FIRST LINE MAINTENANCE (FLM) SERVICES	xiv. Vendor should provide FLM services on 24 X 7 X 365 basis	We request bank to incorporate MHA guideline	Terms & Conditions applicable as per RFP

249	4.5.8 (iv)	CASH REPLENISHMENT / CASH EVACUATION SERVICES	Transit Loss liability for the Vendor will be the total amount given by the Bank to the vendor or to the CIT agencies engaged by them.	Bank to perform recon within 3 days as per circular No. RBI - DCM No. 2746/10.25.07/2018-19 dated May 14, 2019 and provide confirmation on the recon status.	Terms & Conditions applicable as per RFP
251	4.5.9.4 ix	Administrative Maintenance:	The CRA / CIT of the Vendor shall conduct EOD activity on ATM on daily basis and submit necessary reports.	For non cassettes swap 12 EOD/ Loading & 10 for Cassettes swap ATMs	<p><b>CORRIGENDUM:</b>  Administrative Maintenance: <del>The CRA / CIT of the Vendor shall conduct EOD activity on ATM on daily basis and submit necessary reports. At the time of daily end of day activity, CIT shall retrieve and account for mutilated cash from the divert cassette; replenish receipt tapes, ribbons and print cartridges, if _____ required.</del>  The CRA / CIT of the Vendor shall conduct End of Day (EOD) activity on ATM on regular basis, at least on alternate day (minimum 15 days in a month) and submit necessary reports and excess cash, if any, on same day but not later than T+1 day. At the time of EOD activity, CIT shall retrieve and account for mutilated cash from the divert cassette; replenish receipt tapes, ribbons and print cartridges, if required. EOD shall be done on same day as and when Bank demands, without any additional cost to the Bank.</p>

252	4.5.9.4	SCOPE OF SERVICES:	<p>Bank shall provide the required sorted cash of ATM-fit notes to the CIT. Cash indents shall be submitted at cash link branches adequately in advance. Cash is to be issued by Bank from one or more designated branch in each city identified for this purpose. In case of emergency, Bank may direct CRA to collect cash from any other Branch / any other Private or Public Sector Bank / RBI Offices in the city. Vendor shall submit to Bank's designated branch a list of CIT's authorized signatories to sign withdrawal slip; and CIT's authorized operation staff.</p>	<p>The bidder requests the bank to pay the charges on T&amp;M basis for the cash withdrawals done from non-linked branch.</p>	<p>Terms &amp; Conditions applicable as per RFP.</p>
-----	---------	--------------------	---	---	--

252	4.5.9.4.vi	SCOPE OF SERVICES:	Depending upon geography / routes / number of endpoints linked to a particular branch, Vendor shall transport the cash meant for SBI in a dedicated carrier van.	Providing dedicated cash van can be a challenge and needs to be relooked	Terms & Conditions applicable as per RFP: Clarification: If Geography, Routes and number permits, Vendor shall provide dedicated carrier Van
253	4.5.9.4	SCOPE OF SERVICES:	Administrative Maintenance: The CRA / CIT of the Vendor shall conduct EOD activity on ATM on daily basis and submit necessary reports. At the time of daily end of day activity, CIT shall retrieve and account for mutilated cash from the divert cassette; replenish receipt tapes, ribbons and print cartridges, if required	<p>&gt; Need more clarity on daily EOD. Once cassette swap will be implemented then it is as per industry standard.</p> <p>&gt; Bidder recommend EOD only on bank working days, except Sunday/holiday.</p> <p>&gt; Bidder request to give relaxation for sites which is far away or in outskirts, might not be feasible to attend daily, would request alternate day, such list can be shared post implementation.</p>	<p><b>CORRIGENDUM:</b></p> <p><del>Administrative Maintenance: The CRA / CIT of the Vendor shall conduct EOD activity on ATM on daily basis and submit necessary reports. At the time of daily end of day activity, CIT shall retrieve and account for mutilated cash from the divert cassette; replenish receipt tapes, ribbons and print cartridges, if required.</del></p> <p><b>The CRA / CIT of the Vendor shall conduct End of Day (EOD) activity on ATM on regular basis, at least on alternate day (minimum 15 days in a month) and submit necessary reports and excess cash, if any, on same day but not later than T+1 day. At the time of EOD activity, CIT shall retrieve and account for mutilated cash from the divert cassette; replenish receipt tapes, ribbons and print cartridges, if required. EOD shall be done on same day as and when Bank</b></p>



					demands, without any additional cost to the Bank.
253	4.5.9.4 (ix)	Appendix E - Scope of Work SCOPE OF SERVICES - Administrative Maintenance	Administrative Maintenance: The CRA / CIT of the Vendor shall conduct EOD activity on ATM on daily basis and submit necessary reports. At the time of daily end of day activity, CIT shall retrieve and account for mutilated cash from the divert cassette; replenish receipt tapes, ribbons and print cartridges, if required.	Given the current infrastructure, it is not possible to manage 30 days EOD along with cassette swap guidelines and we request the Bank for its reconsideration at alternate day EOD.	<b>CORRIGENDUM:</b> Administrative Maintenance: <del>The CRA / CIT of the Vendor shall conduct EOD activity on ATM on daily basis and submit necessary reports. At the time of daily end of day activity, CIT shall retrieve and account for mutilated cash from the divert cassette; replenish receipt tapes, ribbons and print cartridges, if _____ required.</del> The CRA / CIT of the Vendor shall conduct End of Day (EOD) activity on ATM on regular basis, at least on alternate day (minimum 15 days in a month) and submit necessary reports and excess cash, if any, on same day but not later than T+1 day.. At the time of EOD activity, CIT shall retrieve and account for

					<p>mutilated cash from the divert cassette; replenish receipt tapes, ribbons and print cartridges, if required. EOD shall be done on same day as and when Bank demands, without any additional cost to the Bank.</p>
--	--	--	--	--	--

253	4.5.9.4 (x)	Appendix E - Scope of Work SCOPE OF SERVICES - Administrative Maintenance	x. ATM Balancing: At the time of daily end of day activity CIT shall reconcile physical cash in the Endpoint, ATM cassettes and in the purge bin (reject bin) etc. with the ADMIN balance (end cash shown denomination wise in ADMIN slip) and BGL account 3198 of respective Endpoint. The CIT shall not zeroize the counter. Balancing receipts shall be returned to Bank next day. The CRA / CIT shall perform ADMIN activities at Endpoint as directed by the Bank.	Need more clarity on the same, since bidder's CIT agency must not have access to BGL account 3198	Terms & Conditions applicable as per RFP
-----	-------------	--	---	---	--

253

4.5.9.4  
SCOPE OF  
SERVICES:

Administrative Maintenance: The CRA / CIT of the Vendor shall conduct EOD activity on ATM on daily basis and submit necessary reports. At the time of daily end of day activity, CIT shall retrieve and account for mutilated cash from the divert cassette; replenish receipt tapes, ribbons and print cartridges, if required.

Cassette Swap daily EOD is not possible. Also there will be exceptional cases where EOD cannot be carried out i.e. ATM down, not accessible, vandalism case, power, theft, authority restriction ,CIT feasibility depending on location etc

**CORRIGENDUM:**  
Administrative Maintenance: ~~The CRA / CIT of the Vendor shall conduct EOD activity on ATM on daily basis and submit necessary reports. At the time of daily end of day activity, CIT shall retrieve and account for mutilated cash from the divert cassette; replenish receipt tapes, ribbons and print cartridges, if required.~~  
**The CRA / CIT of the Vendor shall conduct End of Day (EOD) activity on ATM on regular basis, at least on alternate day (minimum 15 days in a month) and submit necessary reports and excess cash, if any, on same day but not later than T+1 day. At the time of EOD activity, CIT shall retrieve and account for mutilated cash from the divert cassette; replenish receipt tapes, ribbons and print cartridges, if required. EOD shall be done on same day as and when Bank demands, without any additional cost to the Bank.**

253	4.5.9.4.1	Appendix E - Scope of Work CASSETTE SWAP SERVICES	Cassette swap Method is mandatory ab-initio to follow by successful bidders. Vendors to replenish/evacuate cash through Cassette Swap Method in terms of RBI's notification No.RBI/2017-18/162DCM(Plg.), No. 3641/10.25.007/2017-18 dated 12th April 2018, RBI/2021-22/71 DCM (Plg.) No. S39/10.25.007/2021-22 dated 12th July 2021 and RBI/2021-22/190 DCM (Plg.) No. S 1117/10.25.007/2021-22 dated 31st March 2022., on Cassette in ATMs.	We are sure that Bank is well aware of the existing challenges & concern regarding the implementation of cassette swap, across industry. Given the situation, IBA was assigned by the RBI to intervene for deciding its guidelines and rollout plan in consultation with Cash and Logistic Association (CLA). Accordingly, we request the Bank to take cognizance of this scenario, since it is beyond the control of the bidder.	Terms & Conditions applicable as per RFP
-----	-----------	--	--	---	--

253	4.5.9.4.1 (ii)	CASSETTE SWAP SERVICES	<p>Cassette swap Method is mandatory ab-initio to follow by successful bidders. Vendors to replenish/evacuate cash through Cassette Swap Method in terms of RBI's notification No.RBI/2017-18/162DCM(Plg.), No. 3641/10.25.007/2017-18 dated 12th April 2018, RBI/2021-22/71 DCM (Plg.) No. S39/10.25.007/2021-22 dated 12th July 2021 and RBI/2021-22/190 DCM (Plg.) No. S 1117/10.25.007/2021-22 dated 31st March 2022., on Cassette in ATMs.</p>	<p>As the Bank is aware of the existing challenges in cassette swap implementation, the IBA has accordingly given guidelines and rollout plan in consultation with CLA, we request Bank to take cognizance of this since this is outside control of the bidder.</p> <p>We propose Bank to include the following: Vendor to comply as per guidelines of IBA for the cassette swap implementation.</p>	Terms & Conditions applicable as per RFP
-----	----------------	------------------------	---	--	--

253	4.5.9.4.1 CASSETTE SWAP SERVICES		iii. In case of noncompliance of specifications of lockable cassettes as per RBI notifications, penalty as stipulated by RBI from time to time and as decided by the Bank (as per appendix-I or anywhere in this RFP) will be imposed on the erring vendors.	Need clarity on lockable. It has to be sealable where one time seal can be tagged	Terms & Conditions applicable as per RFP
253	4.5.9.4.1 ii	CASSETTE SWAP SERVICES	Cassette swap Method is mandatory ab-initio to follow by successful bidders.	Cassettes swap services implemented only at vault available locations as per IBA Categories cities subject to CRA infrastructure availability.	Terms & Conditions applicable as per RFP
253	ix.	4.5.9.4 SCOPE OF SERVICES:	Administrative Maintenance: The CRA / CIT of the Vendor shall conduct EOD activity on ATM on daily basis and submit necessary reports. At the time of daily end of day activity, CIT shall retrieve and account for mutilated cash from the divert cassette; replenish receipt tapes, ribbons	Request to the bank to review the EOD clause for cassette swap ATMs as there is no provision for performing an eod in cassette swap atms.	<b>CORRIGENDUM:</b> Administrative Maintenance: <del>The CRA / CIT of the Vendor shall conduct EOD activity on ATM on daily basis and submit necessary reports. At the time of daily end of day activity, CIT shall retrieve and account for mutilated cash from the divert cassette; replenish receipt tapes, ribbons and print cartridges, if _____ required.</del> <b>The CRA / CIT of the Vendor shall conduct End of Day (EOD) activity on ATM on regular basis, at least on alternate day (minimum 15 days in a month) and submit necessary</b>

			and print cartridges, if required.		reports and excess cash, if any, on same day but not later than T+1 day. At the time of EOD activity, CIT shall retrieve and account for mutilated cash from the divert cassette; replenish receipt tapes, ribbons and print cartridges, if required. EOD shall be done on same day as and when Bank demands, without any additional cost to the Bank.
253	x.	4.5.9.4 SCOPE OF SERVICES:	ATM Balancing: At the time of daily end of day activity CIT shall reconcile physical cash in the Endpoint, ATM cassettes and in the purge bin (reject bin) etc. with the ADMIN balance (end cash shown denomination wise in ADMIN slip) and BGL account 3198 of respective Endpoint. The CIT shall not zeroize the counter. Balancing receipts shall be returned to Bank next day. The CRA / CIT shall	Admin procedures need to be provided by the bank	Terms & Conditions applicable as per RFP



			perform ADMIN activities at Endpoint as directed by the Bank.		
--	--	--	---	--	--

254	3.4.1.10.	Penalty for not maintaining target FoS:	In each Endpoint, replenishment / Evacuation of cash shall ordinarily be done once a day. In case the number of cash replenishment / evacuation is less than 15 days in a month, penalty @ Rs. 1,500/- for each day default for non-compliance of cash replenishment shall be imposed. This penalty shall be in addition to Cash out and other penalties as prescribed elsewhere in this RFP. However, Bank reserves the right to increase the number of Cash replenishment / Cash Evacuation days in a month at its sole discretion, as and when required, without any additional cost to the Bank.	Max- 12 for regular loading and 10 for CS	Terms & Conditions applicable as per RFP
-----	-----------	---	--	---	--

254	4.5.9.4.2	Cash Replenishment / Cash Evacuation:	T+1 calendar day basis, failing which an interest @ clean overdraft rate prevalent at the material time will be recovered from the vendor along with the penalty of Rs 5000/- per instance.	Cassette swap return cash will be deposited by T+2 on T+1 day cash will be counted and reconciled	<b>CORRIGENDUM:</b> The Vendor shall ensure that the entire cash handed over by the Bank is replenished in the ATMs by end of the day against which it had been provided. Reconciliation in this regard must be done on T+1 calendar day basis (where T is the replenishment day), in case of vaulting facility is extended to vendor and/ or on T+0 basis, in case no vaulting facility is extended to Vendor. In any case the cash must reconcile by depositing in Branches on T+1 calendar day basis, failing which an interest @ clean overdraft rate prevalent at the material time will be recovered from the vendor <del>along with the penalty of Rs 5000/-</del> per instance.
254	4.5.9.4.2	Cash Replenishment / Cash Evacuation:	In any case the cash must reconcile by depositing in Branches on T+1 calendar day basis, failing which an interest @ clean overdraft rate prevalent at the material time will be recovered from the vendor along with the penalty of Rs 5000/- per instance.	Very high penalty	<b>CORRIGENDUM:</b> The Vendor shall ensure that the entire cash handed over by the Bank is replenished in the ATMs by end of the day against which it had been provided. Reconciliation in this regard must be done on T+1 calendar day basis (where T is the replenishment day), in case of vaulting facility is extended to vendor and/ or on T+0 basis, in case no vaulting facility is extended to Vendor. In any case the cash must reconcile by depositing in Branches

				<p>on T+1 calendar day basis, failing which an interest @ clean overdraft rate prevalent at the material time will be recovered from the vendor <del>along with the penalty of Rs 5000/-</del> per instance.</p>
--	--	--	--	--

254	4.5.9.4.2	Cash Replenishment / Cash Evacuation:	<p>In each Endpoint, replenishment / Evacuation of cash shall ordinarily be done once a day. In case the number of cash replenishment / evacuation is less than 15 days in a month, penalty @ Rs. 1,500/- for each day default for non-compliance of cash replenishment shall be imposed. This penalty shall be in addition to Cash out and other penalties as prescribed elsewhere in this RFP.</p> <p>However, Bank reserves the right to increase the number of Cash replenishment / Cash Evacuation days in a month at its sole discretion, as and when required, without any additional cost to the Bank.</p>	<p>&gt; Request bank to compensate for Sunday &amp; holiday replenishment.</p> <p>If ATM down, newly taken over, temporary shifting, SLM call logged, vandalism, low dispensing machines (since 15 replenishment is not possible as dispense is low) etc. Bidder is requesting Bank to not impose any other Cash out penalties except RBI. &gt; Penalty is very high, not viable for bidder.</p>	Terms & Conditions applicable as per RFP
-----	-----------	--	--	--	--

254	4.5.9.4.2	Cash Replenishment / Cash Evacuation:	ii. The Vendor shall ensure that the entire cash handed over by the Bank is replenished in the ATMs by end of the day against which it had been provided. Reconciliation in this regard must be done on T+1 calendar day basis (where T is the replenishment day), in case of vaulting facility is extended to vendor and/ or on T+0 basis, in case no vaulting facility is extended to Vendor. In any case the cash must reconcile by depositing in Branches on T+1 calendar day basis, failing which an interest @ clean overdraft rate prevalent at the material time will be recovered from the vendor along with the penalty of Rs	We request bank to cap the penalty of 100/-	<b>CORRIGENDUM:</b> The Vendor shall ensure that the entire cash handed over by the Bank is replenished in the ATMs by end of the day against which it had been provided. Reconciliation in this regard must be done on T+1 calendar day basis (where T is the replenishment day), in case of vaulting facility is extended to vendor and/ or on T+0 basis, in case no vaulting facility is extended to Vendor. In any case the cash must reconcile by depositing in Branches on T+1 calendar day basis, failing which an interest @ clean overdraft rate prevalent at the material time will be recovered from the vendor <del>along with the penalty of Rs 5000/-</del> per instance.
-----	-----------	--	--	---	--

		5000/- per instance.		
--	--	----------------------	--	--

254	4.5.9.4.2	Cash Replenishment / Cash Evacuation:	<p>In each Endpoint, replenishment / Evacuation of cash shall ordinarily be done once a day. In case the number of cash replenishment / evacuation is less than 15 days in a month, penalty @ Rs. 1,500/- for each day default for noncompliance of cash replenishment shall be imposed. This penalty shall be in addition to Cash out and other penalties as prescribed elsewhere in this RFP. However, Bank reserves the right to increase the number of Cash replenishment / Cash Evacuation days in a month at its sole discretion, as and when required, without any additional cost to the Bank.</p>	We request bank to cap the penalty of 100/-	Terms & Conditions applicable as per RFP.
-----	-----------	--	--	---	---



254	4.5.9.4.2	Cash Replenishment / Cash Evacuation:	<p>ii. The Vendor shall ensure that the entire cash handed over by the Bank is replenished in the ATMs by end of the day against which it had been provided. Reconciliation in this regard must be done on T+1 calendar day basis (where T is the replenishment day), in case of vaulting facility is extended to vendor and/ or on T+0 basis, in case no vaulting facility is extended to Vendor. In any case the cash must reconcile by depositing in Branches on T+1 calendar day basis, failing which an interest @ clean overdraft rate prevalent at the material time will be recovered from the vendor along with the penalty of Rs 5000/- per instance.</p>	<p>&gt; If indented machine is non-operational at the time of replenishment then would request to allow vaulting cash (if vault available). &gt; If vault is unavailable then it will be loaded into some other machine.</p> <p>Bidder is requesting Bank to not impose any other Cash out penalties except RBI</p>	<p><b>CORRIGENDUM:</b> The Vendor shall ensure that the entire cash handed over by the Bank is replenished in the ATMs by end of the day against which it had been provided. Reconciliation in this regard must be done on T+1 calendar day basis (where T is the replenishment day), in case of vaulting facility is extended to vendor and/ or on T+0 basis, in case no vaulting facility is extended to Vendor. In any case the cash must reconcile by depositing in Branches on T+1 calendar day basis, failing which an interest @ clean overdraft rate prevalent at the material time will be recovered from the vendor <del>along with the penalty of Rs 5000/-</del> per instance.</p>
-----	-----------	--	---	---	--

254	4.5.9.4.2 (ii)	Appendix E - Scope of Work Cash Replenishment / Cash Evacuation	<p>The Vendor shall ensure that the entire cash handed over by the Bank is replenished in the ATMs by end of the day against which it had been provided. Reconciliation in this regard must be done on T+1 calendar day basis (where T is the replenishment day), in case of vaulting facility is extended to vendor and/ or on T+0 basis, in case no vaulting facility is extended to Vendor. In any case the cash must reconcile by depositing in Branches on T+1 calendar day basis, failing which an interest @ clean overdraft rate prevalent at the material time will be recovered from the vendor along with the penalty of Rs 5000/- per instance.</p>	<p>During Weekends, Public/Regional Holidays, Road Blocks, Strikes, Elections Procession, Branch closed and Bank Holiday if the Bank's Feeder/Nodal branch is not working or open, the cash can't be deposited back to the branches on a T+1 calendar day basis. Under such scenario, we need an exclusion from the Bank, basis the justification/reason provided by the bidder, for non returning of cash on T+1 basis.</p>	<p><b>CORRIGENDUM:</b> The Vendor shall ensure that the entire cash handed over by the Bank is replenished in the ATMs by end of the day against which it had been provided. Reconciliation in this regard must be done on T+1 calendar day basis (where T is the replenishment day), in case of vaulting facility is extended to vendor and/ or on T+0 basis, in case no vaulting facility is extended to Vendor. In any case the cash must reconcile by depositing in Branches on T+1 calendar day basis, failing which an interest @ clean overdraft rate prevalent at the material time will be recovered from the vendor <del>along with the penalty of Rs 5000/-</del> per instance.</p>
-----	----------------	---	---	--	--

254	4.5.9.4.2 (iii)	Appendix E - Scope of Work Cash Replenishment / Cash Evacuation	In each Endpoint, replenishment / Evacuation of cash shall ordinarily be done once a day. In case the number of cash replenishment / evacuation is less than 15 days in a month, penalty @ Rs. 1,500/- for each day default for non-compliance of cash replenishment shall be imposed. This penalty shall be in addition to Cash out and other penalties as prescribed elsewhere in this RFP. However, Bank reserves the right to increase the number of Cash replenishment / Cash Evacuation days in a month at its sole discretion, as and when required, without any additional cost to the Bank	Requesting Bank to consider the EOD count instead of cash replenishment/evacuation count alone. Since there will be few instances, when Feeder/Nodal branch may not issue cash due to some internal concern or any other reason under Bank's pendency and still CRA has performed the EOD process	Terms & Conditions applicable as per RFP. Clarification: EOD and Cash replenishment may be perform seperately.
-----	-----------------	---	---	--	---

254	4.5.9.4.2 Cash Replenishment / Cash Evacuation:	<p>ii. The Vendor shall ensure that the entire cash handed over by the Bank is replenished in the ATMs by end of the day against which it had been provided. Reconciliation in this regard must be done on T+1 calendar day basis (where T is the replenishment day), in case of vaulting facility is extended to vendor and/ or on T+0 basis, in case no vaulting facility is extended to Vendor. In any case the cash must reconcile by depositing in Branches on T+1 calendar day basis, failing which an interest @ clean overdraft rate prevalent at the material time will be recovered from the vendor along with the penalty of Rs 5000/- per instance.</p>	<p>Cassette swap process 100% cash will be required to be vaulted. Interest rate as well as penalty needs relaxation.</p>	<p><b>CORRIGENDUM:</b> The Vendor shall ensure that the entire cash handed over by the Bank is replenished in the ATMs by end of the day against which it had been provided. Reconciliation in this regard must be done on T+1 calendar day basis (where T is the replenishment day), in case of vaulting facility is extended to vendor and/ or on T+0 basis, in case no vaulting facility is extended to Vendor. In any case the cash must reconcile by depositing in Branches on T+1 calendar day basis, failing which an interest @ clean overdraft rate prevalent at the material time will be recovered from the vendor <del>along with the penalty of Rs 5000/-</del> per instance.</p>
-----	--	---	---	--

254	4.5.9.4.2 Cash Replenishment / Cash Evacuation:		iii. In each Endpoint, replenishment / Evacuation of cash shall ordinarily be done once a day. In case the number of cash replenishment / evacuation is less than 15 days in a month, penalty @ Rs. 1,500/- for each day default for non-compliance of cash replenishment shall be imposed. This penalty shall be in addition to Cash out and other penalties as prescribed elsewhere in this RFP. However, Bank reserves the right to increase the number of Cash replenishment / Cash Evacuation days in a month at its sole discretion, as and when required, without any additional cost to the Bank.	Cassette swap 15 loads in a month means almost daily attempt. Wear and tear of cassette will be on higher side. For ADD cash & cassette swap there will be exceptional cases where replenishment / evacuation cannot be carried out i.e. ATM down, not accessible, vandalism case, power, theft, authority restriction ,CIT feasibility depending on location etc	Terms & Conditions applicable as per RFP
-----	--	--	---	---	--

254	4.5.9.4.2 i	Cash Replenishment / Cash Evacuation:	The Successful Bidder/ its appointed CRA/CIT to use the "Cassette Swap" Method ab-initio for Cash replenishment as advised by RBI.	Cassettes swap services implemented only at vault available locations as per IBA Categories cities subject to CRA infrastructure availability.	Terms & Conditions applicable as per RFP
254	4.5.9.4.2 ii	Cash Replenishment / Cash Evacuation:	In any case the cash must reconcile by depositing in Branches on T+1 calendar day basis, failing which an interest @ clean overdraft rate prevalent at the material time will be recovered from the vendor along with the penalty of Rs 5000/- per instance.	Not Acceptable - We will ensure to close reference number in given time but penalty on reference number is not acceptable.	<b>CORRIGENDUM:</b> The Vendor shall ensure that the entire cash handed over by the Bank is replenished in the ATMs by end of the day against which it had been provided. Reconciliation in this regard must be done on T+1 calendar day basis (where T is the replenishment day), in case of vaulting facility is extended to vendor and/ or on T+0 basis, in case no vaulting facility is extended to Vendor. In any case the cash must reconcile by depositing in Branches on T+1 calendar day basis, failing which an interest @ clean overdraft rate prevalent at the material time will be recovered from the vendor <del>along with the penalty of Rs 5000/-</del> per instance.

254	4.5.9.4.2 iii	Cash Replenishment / Cash Evacuation:	In each Endpoint, replenishment / Evacuation of cash shall ordinarily be done once a day. In case the number of cash replenishment / evacuation is less than 15 days in a month, penalty @ Rs. 1,500/- for each day default for non-compliance of cash replenishment shall be imposed.	No Penalty Acceptable for this. For non cassettes swap 12 EOD/ Loading & 10 for Cassettes swap ATMs	Terms & Conditions applicable as per RFP
-----	---------------	--	--	---	--

254	4.5.9.4.2 iii)	Cash Replenishment / Cash Evacuation	<p>In each Endpoint, replenishment / Evacuation of cash shall ordinarily be done once a day. In case the number of cash replenishment / evacuation is less than 15 days in a month, penalty @ Rs. 1,500/- for each day default for non-compliance of cash replenishment shall be imposed. This penalty shall be in addition to Cash out and other penalties as prescribed elsewhere in this RFP. However, Bank reserves the right to increase the number of Cash replenishment / Cash Evacuation days in a month at its sole discretion, as and when required, without any additional cost to the Bank</p>	<p><b>Bank is requested to not duplicate penalty for an ATM and consider amount under single line item whichever highest for the day. Overlapping downtime is a helpless situation for any MSP</b></p> <p><b>Also, with 26 Banking days in a month we request Bank to revise the minimum to 12 Loadings in Metro &amp; Urban, 10 in Semi-Urban &amp; 8 in Rural locations</b></p>	Terms & Conditions applicable as per RFP
-----	----------------	---	--	---	--



254	4.5.9.4.5	OTHER TERMS:	<p>C. The Vendor / CIT shall ensure correctness and genuineness of the cash and shall take only ATM / Endpoint fit currency notes for replenishment to its possession. Counting facility for currency notes shall be provided by the Bank. Once the note packets are received and acknowledged, Vendor would be responsible for shortage and fake currency if any, noticed subsequently. A penalty of Rs 10,000/- per instance will be levied on the vendor whenever any Counterfeit Currency is detected by any manner from the following: -</p>	<p>We request bank to remove this penalty clause as this is not applicable</p>	<p>Terms &amp; Conditions applicable as per RFP</p>
-----	-----------	--------------	---	--	---

254	iii.	4.5.9.4.2 Cash Replenishment / Cash Evacuation:	<p>n each Endpoint, replenishment / Evacuation of cash shall ordinarily be done once a day. In case the number of cash replenishment / evacuation is less than 15 days in a month, penalty @ Rs. 1,500/- for each day default for noncompliance of cash replenishment shall be imposed. This penalty shall be in addition to Cash out and other penalties as prescribed elsewhere in this RFP. However, Bank reserves the right to increase the number of Cash replenishment / Cash Evacuation days in a month at its sole discretion, as and when required, without any additional cost to the Bank.</p>	<p>Request bank to review and reduce the penalty amount. Also request to consider the exceptions like technical issues because of which EOD or replenishment cant be done.</p>	<p>Terms &amp; Conditions applicable as per RFP</p>
-----	------	---	---	--	---

255	4.5.9.4.4	<b>CURRENCY VAULTING SERVICES: -</b>	<p>With this arrangement, the replenishment of cash in Endpoints can begin at early morning hours by providing cash to vendors 1 day prior (T-1) to replenishing day (T) at the centres where Vaulting Facility is permitted. The vendor will share the ATM wise, denomination-wise indent on T-2 days to the respective Currency Chest / Cash-linked Branches of the Endpoints as per the cash dispensation pattern of the respective ATMs.</p>	<p>&gt; Bidder would send tentative cash requirement on T-2, would request bank to confirm cash availability at denomination level, then final indent would go on T-1 for cash withdrawal. There might be variation +/-30 to 50% between tentative vs final indent due to abnormal dispense, execution of indented value, CRA failure etc.</p> <p>&gt; Bidder will dispatch routes from overnight vaulting cash in vaulting location &amp; wouldn't be responsible for cash out if bank issued less cash at denomination level for overnight vaulting.</p> <p>&gt; Bidder would not able to return cash on same day if machine is faulty even though bank working.</p> <p>&gt; It is not possible to dispatch routes with 15% of cash in vault, partial routes can't be dispatch thus would request to revoke this equation.</p>	<p>Terms &amp; Conditions applicable as per RFP</p>
-----	-----------	--------------------------------------	--	--	---

255	4.5.9.4.4 v	CURRENCY VAULTING SERVICES: -	The indented cash will be given to the CITs on T-1 day during the Banking hours.	In vaulting locations, we observed branches considering T-1 as "T" day of withdrawal which impacting additional day for reference number closing.	Terms & Conditions applicable as per RFP
-----	-------------	-------------------------------	--	---	--

256	4.5.9.4.4	CURRENCY VAULTING SERVICES: -	<p>As daily vaulting is permitted, the vendors to ensure compliance on the following: -</p> <p>a) Cash outs should be zero. All efforts will be made by Bank to provide the indented cash 1 day prior with overnight vaulting provision in the required denominations.</p> <p>b) VIP / High-Hit ATMs to be replenished twice / thrice a day, if required, and without any cost to the bank</p> <p>c) In no case, idle cash should be present in ATMs. There should not be over-indenting of cash.</p> <p>d) Vaults will be subjected to audits by the RBI/ Bank / Auditors whenever required.</p> <p>e) Sufficient insurance has to be ensured and a copy of the policy to be provided to LHOs.</p>	<p>&gt; For VIP / High-Hit ATMs- Bidder would try best subject to geographic reach.</p> <p>&gt; Bidder would send tentative cash requirement on T-1, would request bank to confirm cash availability at denomination level, then final indent would go on T early morning for cash withdrawal. There might be variation +/-30 to 50% between tentative vs final indent due to abnormal dispense, execution of indented value, CRA failure etc.</p>	<p><b>CORRIGENDUM:</b>  <del>b) VIP / High Hit ATMs to be replenished twice / thrice a day, if required, and without any cost to the bank</del></p>
-----	-----------	-------------------------------	---	--	---

256	4.5.9.4.4 CURRENCY VAULTING SERVICES: -		b) VIP / High-Hit ATMs to be replenished twice / thrice a day, if required, and without any cost to the bank	Bank needs to pay the charges if cash is not given as per requirement. Also Cassette swap model it will not be possible to carry out loading twice a day.	<b>CORRIGENDUM:</b> b) <del>VIP / High Hit ATMs to be replenished twice / thrice a day, if required, and without any cost to the bank</del>
256	4.5.9.4.4 x)	CURRENCY VAULTING SERVICES	VIP / High-Hit ATMs to be replenished twice / thrice a day, if required, and without any cost to the bank	Aligning with the trend and in order to meet the stringent FoS norms, unexpected dispense should not be considered for penalty. Loading twice a day is not a practical possibility specially in any population group	<b>CORRIGENDUM:</b> b) <del>VIP / High Hit ATMs to be replenished twice / thrice a day, if required, and without any cost to the bank</del>
256	x.e)	CURRENCY VAULTING SERVICES	A. Daily Overnight Vaulting Facility (T-1 Vaulting): Sufficient insurance has to be ensured and a copy of the policy to be provided to LHOs	We request Bank to clarify on the nature of insurance referred to in this clause.	Terms & Conditions applicable as per RFP

257	4.5.9.4.5	Daily EOD	<p>Vendor shall arrange for daily EOD and prepare daily End-of-Day (EOD) activity report [ATM ID wise] as per prescribed format mentioned in Annexure-4 to this Cash Appendix, supervisory counters and admin slips under the signature of Vendor / their representative/s performing cash replenishment and submit to Bank same day but not later than next day. Vendor shall provide Cash Balance Report (CBR), Vault Closing Balance Report (VCB) and Overage &amp; Shortage Report (OSR) as per format mentioned in Annexure-5 to Bank designated linked branch daily via e-mail.</p>	<p>Considering the CRA feasibility challenge Max- 12 EOD for regular loading and max. 10 EOD for CS</p>	<p><b>CORRIGENDUM:</b>  Vendor shall arrange for <del>daily</del> EOD as per Scope of Services under Cash Appendix of this RFP and prepare daily End-of-Day (EOD) activity report [ATM ID wise] as per prescribed format mentioned in Annexure-4 to this Cash Appendix, supervisory counters and admin slips under the signature of Vendor / their representative/s performing cash replenishment and submit to Bank same day but not later than next day. Vendor shall provide Cash Balance Report (CBR), Vault Closing Balance Report (VCB) and Overage &amp; Shortage Report (OSR) as per format mentioned in Annexure-5 to Bank designated linked branch daily via e-mail.</p>
-----	-----------	-----------	---	---	--

257	4.5.9.4.5	OTHER TERMS	<p>Settlement &amp; Vault Reporting: Vendor shall arrange for daily EOD and prepare daily End-of-Day (EOD) activity report [ATM ID wise] as per prescribed format mentioned in Annexure-4 to this Cash Appendix, supervisory counters and admin slips under the signature of Vendor / their representative/s performing cash replenishment and submit to Bank same day but not later than next day.</p>	<p>Daily EOD is not at all feasible given the geographical spread and limited CRA infrastructure. We request Bank to modify it to alternate day EOD.</p>	<p><b>CORRIGENDUM:</b> Vendor shall arrange for <del>daily</del> EOD as mentioned in Scope of Services under Cash Appendix of this RFP and prepare daily End-of-Day (EOD) activity report [ATM ID wise] as per prescribed format mentioned in Annexure-4 to this Cash Appendix, supervisory counters and admin slips under the signature of Vendor / their representative/s performing cash replenishment and submit to Bank same day but not later than next day. Vendor shall provide Cash Balance Report (CBR), Vault Closing Balance Report (VCB) and Overage &amp; Shortage Report (OSR) as per format mentioned in Annexure-5 to Bank designated linked branch daily via e-mail.</p>
257	4.5.9.4.5 OTHER TERMS	iii. Currency Sorting:	<p>Bank shall take RFP FOR TOM P-XVII 13,500 ATMs Page 258 of 421 Undertaking Letter {as per format in Annexure-6 of this cash appendix}</p>	<p>We request bank to remove this penalty clause as this is not applicable</p>	<p>Terms &amp; Conditions applicable as per RFP</p>



257	4.5.9.4.5 OTHER TERMS	Settlement & Vault Reporting:	Vendor shall arrange for daily EOD and prepare daily End-of-Day (EOD) activity report [ATM ID wise] as per prescribed format mentioned in Annexure-4 to this Cash Appendix, supervisory counters and admin slips under the signature of Vendor / their representative/s performing cash replenishment and submit to Bank same day but not later than next day. Vendor shall provide Cash Balance Report (CBR), Vault Closing Balance Report (VCB) and Overage & Shortage Report (OSR) as per format mentioned in Annexure-5 to Bank designated linked branch daily via e-mail.	<p>&gt; The necessary reconciled C3R/MIS reports shall be submitted on T+1 before EOD and pending reports (un-reconciled) shall be submitted on T+2 post validation.</p> <p>&gt; Request bank to share necessary feed file to validate reports such as EOD-to-EOD dispense.</p>	<p><b>CORRIGENDUM:</b> Vendor shall arrange for <del>daily</del> EOD as mentioned in Scope of Services under Cash Appendix of this RFP and prepare daily End-of-Day (EOD) activity report [ATM ID wise] as per prescribed format mentioned in Annexure-4 to this Cash Appendix, supervisory counters and admin slips under the signature of Vendor / their representative/s performing cash replenishment and submit to Bank same day but not later than next day. Vendor shall provide Cash Balance Report (CBR), Vault Closing Balance Report (VCB) and Overage &amp; Shortage Report (OSR) as per format mentioned in Annexure-5 to Bank designated linked branch daily via e-mail.</p>
-----	-----------------------------	----------------------------------	--	---	--

257

4.5.9.4.5  
OTHER  
TERMS: - iii.  
Currency  
Sorting:

A. The Vendor / CIT agencies shall check the quality and quantity of the currency notes at the time of delivery by the Bank before taking the same to their vaults or / and direct loadings in the machines. Bank shall take Undertaking Letter {as per format in Annexure-6 of this cash appendix} whenever the cash is handed over to Vendor / CIT. Acknowledgement of the cash handed over to Vendor / CIT to be taken in a register maintained for this purpose. If any shortfall is noticed thereafter, Vendor shall be responsible for the same. Wherever possible, Bank shall provide to the CIT agencies space and Note Sorting machines for the purpose. Any

Bank will have to provide counting machine and space to count the cash. Wherever counting is not possible CIT will count the cash in CIT vault under CCTV camera and discrepancy will be highlighted with proof where Bank will have to support on shortage / mutilated note/ fake notes if any.

Terms & Conditions applicable as per RFP

		<p>subsequent claim for any manner shall not be entertained by the bank.</p>		
--	--	--	--	--

258	-	OTHER TERMS:	Any shortage of cash because of Vendor / CIT (engaged by the Vendor) activities, whatsoever and for whatever reason, shall be made good to the Bank within 7 days without waiting for admissibility or settlement of the insurance claim. In the event of failure on the part of the vendor to pay for cash losses as per the terms and conditions, the Bank shall be entitled to invoke the Bank Guarantee(s).	Legal formalities take time, it should be 15 days	Terms & Conditions applicable as per RFP
-----	---	--------------	---	---	--

258	4.5.9.4.5 iv	Cash out Exclusions:	Vendor shall not be responsible for cash outs and related downtime of endpoint, if it arises due to following reasons:	<p>Require cash out exclusion for below points also.</p> <ol style="list-style-type: none"> <li>1. If cash not provided by branch till 12 PM in non vaulting locations.</li> <li>2. ATM down at the time of replenishment.</li> <li>3. Cash not received as per denomination.</li> <li>4. Cassettes swap ATMs - as cash out ticket generated once switch decrease to zero while cassettes swap replenishment.</li> <li>5. Cash loading not done due to natural calamities. like Earthquake, flood etc</li> <li>6. Unexpected / High dispense while comparing previous months dispense &amp; Cash out due to maintain FOS.</li> </ol>	Terms & Conditions applicable as per RFP
-----	--------------	----------------------	--	--	--

258	4.5.9.4.5 OTHER TERMS: -	Cash out Exclusions:	<p>Cash out Exclusions: Vendor shall not be responsible for cash outs and related downtime of endpoint, if it arises due to following reasons:</p> <p>a) Quantum of cash not received as per indents raised by Vendor. However, bank has discretion to provide lesser quantum of cash than the indents raised by vendor considering the dispensation pattern of Endpoint and the cash available with the Bank Branch.</p> <p>b) If the Endpoint stops dispensing a particular denomination and it is needed that the ATM should be configured to continue dispensing the other remaining denomination.</p>	<p>&gt; Request to give relaxation for cash out...</p> <p>i. Non-availability of cash as per bidder's cash indent;</p> <p>ii. Non-availability of denominations as per bidder's cash indent;</p> <p>iii. Non-issuance of cash from the cash issuing branch of the bidder as per agreed time for each location;</p> <p>iv. Abnormal increase in cash withdrawals by cardholders, high dispensation from machine;</p> <p>v) Late cash issuancy by bank, i.e. after 11 AM.</p> <p>vi) There should be relaxation for uncontrollable factors, natural disasters &amp; also there could be possibility of loading/EOD skip by bidder/CRA due to abnormal/uncontrollable situation like riots, force meajure, far offsites, transportations, area power failure, SLM bank dependency, access restriction, captive sites, ATM down at the time of loading etc.</p> <p>vii) Far offsite machine, where replenishment couldn't be</p>	Terms & Conditions applicable as per RFP
-----	--------------------------------	----------------------	--	--	--

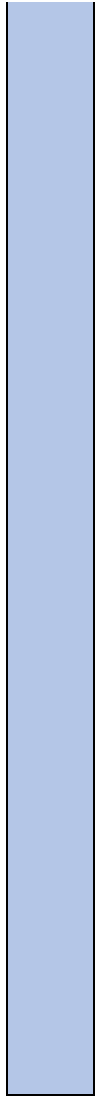

possible daily, bidder can share such list.

258	iii.	Currency Sorting:	<p>C. The Vendor / CIT shall ensure correctness and genuineness of the cash and shall take only ATM / Endpoint fit currency notes for replenishment to its possession. Counting facility for currency notes shall be provided by the Bank. Once the note packets are received and acknowledged, Vendor would be responsible for shortage and fake currency if any, noticed subsequently. A penalty of Rs 10,000/- per instance will be levied on the vendor whenever any Counterfeit Currency is detected by any manner</p>	Bidder is requesting Bank to not impose any other Cash out penalties except RBI	Terms & Conditions applicable as per RFP
-----	------	-------------------	---	---	--



258	iv.	Cash out Exclusions:	Vendor shall not be responsible for cash outs and related downtime of endpoint, if it arises due to following reasons:.....	Request bank to add one more exception i.e. in case CRA unable to load the ATM due to technical problem and unforeseen reasons.	<p><b>CORRIGENDUM:</b>  <del>Quantum of cash not received as per indents raised by Vendor. However, bank has discretion to provide lesser quantum of cash than the indents raised by vendor considering the dispensation pattern of Endpoint and the cash available with the Bank Branch.</del>  <b>Quantum of cash not received as per indents raised by Vendor based on the dispensation pattern of Endpoint(s) and / or as per the envisaged Factor of safety (FoS) mentioned in this RFP.</b></p>
258		iv. Cash out Exclusions	Vendor shall not be responsible for cash outs and related downtime of endpoint, if it arises due to following reasons:	Bank should give exclusion on below pointes Less / no cash given by bank delay cash given by bank un controlable cases like local strike , flood , road block , etc technical issues in machine / link down Justifiable hike in dispense then normal dispense trend .	<p><b>CORRIGENDUM:</b>  <del>Quantum of cash not received as per indents raised by Vendor. However, bank has discretion to provide lesser quantum of cash than the indents raised by vendor considering the dispensation pattern of Endpoint and the cash available with the Bank Branch.</del>  <b>Quantum of cash not received as per indents raised by Vendor based on the dispensation pattern of Endpoint(s) and / or as per the envisaged Factor of safety (FoS) mentioned in this RFP.</b></p>

259	4.5.9.4.6	USE OF ONE TIME COMBINATION (OTC) FOR ENDPOINT VAULTS	Vendor has to ensure that all Endpoints are operated for cash activities only with digital One Time Combination (OTC) locks. Any key / hardware required to operationalize and use OTC must be arranged by the Bidder at their own cost. Endpoints are to be made cash live with OTC. Any machine which is Cash live and not OTC enabled, will attract penal provisions of Rs. 500/- per day till the date on which the machine is OTC enabled.	Keys required for activation, need 7~days from Tech live to activate OTC	Terms & Conditions applicable as per RFP
259	4.5.9.4.6,	USE OF ONE TIME COMBINATION (OTC) FOR ENDPOINT VAULTS: -	Any machine which is Cash live and not OTC enabled, will attract penal provisions of Rs. 500/- per day till the date on which the machine is OTC enabled	Bidder request 7 days time from date of CL to activate lock on OTC mode	Terms & Conditions applicable as per RFP

259	4.5.9.4.6,	USE OF ONE TIME COMBINATION (OTC) FOR ENDPOINT VAULTS: -	The cost of combination lock including all keys (Black and red), any peripherals, any hardware (like Bluetooth dongle / devise for usage of OTC) if required to be replaced during the contract period shall be borne by Vendor, without any cost to Bank. Any defective lock shall be broken open by Vendor at their cost. Further, breaking open the safe lock shall be required to be done without any additional cost to the Bank and the liability of any destroyed currency in the safe rests with the Vendor.	Key damaged due to mishandling of bank team or lost by Bank would need commercial from Bank to replace	Terms & Conditions applicable as per RFP
-----	------------	--	--	--	--

260	4.5.9.4.6 USE OF ONE TIME COMBINATION (OTC) FOR ENDPOINT VAULTS: -		ix. If the Bank provides a generic tool for monitoring of movement of cash the Vendor shall integrate it with their system without any additional cost to the Bank.	Need to check the feasibility on software development and integration with Bank tool. None of the CIT has got the central tracking mechanism for movement of cash.	<b>CORRIGENDUM:</b> <del>ix. If the Bank provides a generic tool for monitoring of movement of cash the Vendor shall integrate it with their system without any additional cost to the Bank.</del>
-----	--	--	---	--	---

260	4.5.9.4.7.iii	CURRENCY VAULTING SERVICES	<p>The Vendor will keep all the Endpoints insured against theft, fire and any other damage which may result loss / damage to the cash kept inside the Endpoints. Fidelity insurance shall also be with the Vendor. The Vendor shall be liable to the Bank for the any loss so caused in all conditions (whether insurance claim is settled by the Insurance Company or not) within 15 (fifteen) working days from the date of loss. Bank does not demand an exclusive policy if CRA is under an umbrella policy of the Insurance Agency. Fidelity insurance cover should be for 20% higher limit than maximum cash withdrawn from currency chest on a particular day shall be obtained by CRA.</p>	<p>Fidelity insurance cover is sought for both vendor and CRA. Please clarify as this should not be duplicated.</p>	<p>Terms &amp; Conditions applicable as per RFP:</p>
-----	---------------	----------------------------	--	---	--

261	4.5.9.4.8	BANK GUARANTEE FOR CASH SERVICES:	BANK GUARANTEE FOR CASH SERVICES: -	The bidder requests the bank to clarify if this will be over and above the BG of 8%?	Terms & Conditions applicable as per RFP: Clarification: it shall be over and above PBG.
261	4.5.9.4.8 BANK GUARANTEE FOR CASH SERVICES: -	BANK GUARANTEE FOR CASH SERVICES: -	In the event of failure on the part of the vendor to pay for cash losses, the Bank shall be entitled to invoke the Bank Guarantee(s).	Requested Changes : Bank should not invoke Bank Guarantee without the consent of Bidder.	Terms & Conditions applicable as per RFP
261	4.5.9.4.9	Appendix-E	Cash Reconciliation:	The Bank shall come up with any dispute within 7 days of Successful Bidder, failing which it shall be deemed to been accepted reconciliation by the Bank	Terms & Conditions applicable as per RFP

262	4.5.9.4.10	RECOVERY OF LOSSES	<p>In case of any ATM loss (es), discrepancy / difference in the report generated on the ATM and the physical / actual cash, if after Vendor investigation, it is proved that the shortage / difference of cash, if any, between the report generated and the physical cash, is on account of the lapses on the part of the CIT, Vendor shall make the payment within 7 (seven) days from the day it is proved.</p>	<p>Bidder shall not be responsible for wrong process / breach of processes by the branches. Customer disputes / claims to be closed by the branches based on the observation provided by the Bidder. Bidder should not be penalised for any wrong doing of the branches.</p>	<p>Terms &amp; Conditions applicable as per RFP</p>
-----	------------	--------------------	---	--	---

262	4.5.9.4.10	RECOVERY OF LOSSES:	In case of any ATM loss (es), discrepancy / difference in the report generated on the ATM and the physical / actual cash, if after Vendor investigation, it is proved that the shortage / difference of cash, if any, between the report generated and the physical cash, is on account of the lapses on the part of the CIT, Vendor shall make the payment within 7 (seven) days from the day it is proved.	too short to repay, need two weeks	Terms & Conditions applicable as per RFP
-----	------------	---------------------	--	------------------------------------	--



262	4.5.9.4.10	RECOVERY OF LOSSES: -	<p>iii. Defrauded amount if any, shall be by made good along with interest thereon at Banks' prevailing clean overdraft interest rate at material time along with penalty at the rate of Rs.10,000 per Rs. One lakh or part thereof, by Vendor to Bank within 30 (thirty) days of occurrence of such fraud without waiting for admissibility or settlement of the insurance claim, if any. If the Vendor fails to make such payment with the said period of 30 days, then Bank reserves the right to recover the same from monthly invoices or / and by invoking the Bank Guarantee(s) submitted.</p>	<p>MSP should not be penalized over and above actual loss for theft/misappropriation done for CRA vendor.</p>	<p>Terms &amp; Conditions applicable as per RFP</p>
-----	------------	-----------------------	---	---	---

262	4.5.9.4.10.iii	RECOVERY OF LOSSES	<p>Defrauded amount if any, shall be by made good along with interest thereon at Banks' prevailing clean overdraft interest rate at material time along with penalty at the rate of Rs.10,000 per Rs. One lakh or part thereof, by Vendor to Bank within 30 (thirty) days of occurrence of such fraud without waiting for admissibility or settlement of the insurance claim, if any. If the Vendor fails to make such payment with the said period of 30 days, then Bank reserves the right to recover the same from monthly invoices or / and by invoking the Bank Guarantee(s) submitted</p>	<p>We request the Bank to remove the interest on fraudulent transactions since the Bank can recover the amount from the subsequent monthly invoice of the vendor. Hence there is no requirement for charging interest. This is also not followed as industry practice</p>	<p>Terms &amp; Conditions applicable as per RFP</p>
-----	----------------	--------------------	---	---	---

264	4.5.9.4.12 LIABILITY: -		vii. In addition to the damages and remedies expressly set forth in this Cash Appendix, Vendor shall be liable to Bank, either directly or bypass-through claims of indemnity or contribution for claims of third parties, for any moneys, damages, relief, or remedies, irrespective of whether the claim arises in common law, tort, statute, or equity.	Third pary losses should not be attributed to the bidder	Terms & Conditions applicable as per RFP
266	ANNEXURE-1:	Criteria for Selection of CRA/CIT	(e) "private security" or "private security agency" shall have the same meaning as assigned to it in clause (f) or clause (g) of section 2 of the Private Security Agencies (Regulation) Act, 2005;	This is not applicable to the service rendered by us and	Terms & Conditions applicable as per RFP

269	4. C.1 (f)(3)	DESIGN AND SPECIFICATION FOR SECURED CASH VANS	<p>The cash van shall always be escorted by at least two trained armed security guards on board:  Every private security agency shall be responsible to comply with the following checks before an individual is appointed or engaged to participate in cash transportation activities, namely</p>	<p>The private security agency is appointed by the CRA directly and not by the vendor. We request the Bank to specifically add reference to appointment by the CRA in this clause.</p>	<p>Terms &amp; Conditions applicable as per RFP</p>
-----	---------------	--	--	--	---

272	other points	Appendix-E	<p>Private Security for cash transportation activities, etc.- (1) No private security shall be provided by the private security agency for cash transportation activities unless he holds a license under the Act.</p> <p>i. For the purpose of providing private security for cash transportation activities, a contract may be entered into between, -</p> <p>(a) a private security agency holding a license under the Act and the MS Vendor/ CIT/CRA or</p> <p>(b) a cash handling agency and the MS vendor/ CIT/CRA concerned:</p> <p>Provided that in case the cash handling agency holds a license as a private security agency under the provisions of the Act, such cash handling</p>	<p>As there is no security services provided under this RFP. Private Security License is not applicable. Request Bank to delete this point.</p>	<p>Terms &amp; Conditions applicable as per RFP</p>
-----	--------------	------------	--	---	---

		<p>agency may itself provide the private security to cash transportation activities in accordance with the provisions of these rules.</p>		
--	--	---	--	--

272	THE FIRST SCHEDULE [See rule 4(1) of MHA Model Rules f) Requisite number of trained staff per cash van. — (	MHA	(x) Private Security for cash transportation activities, etc.- (1) No private security shall be provided by the private security agency for cash transportation activities unless he holds a license under the Act.	We request bank to remove this clause as this is not applicable and bank already covered penalty in other penalty clause	Terms & Conditions applicable as per RFP
283	ANNEXURE-6	CASH APPENDIX	We undertake that we have received sorted and issuable cash from the Branch and cash is sorted through the Note Sorting Machine (NSM). We are responsible for disbursing any fake note in the particular ATM.	FSS will not responsible if any Fake note issue raised by customer after withdrawal. Secondly some branches don't have cash sorting machine. This is subject to cash sorting machine availability.	Terms & Conditions applicable as per RFP

283	ANNEXURE-6 OF CASH APPENDIX	Annexure-6	Format	We request bank to remove the clause as UNDERTAKING letter is Not applicable	Terms & Conditions applicable as per RFP
285	5.2a	PROJECT PLAN, DELIVERY AND SCHEDULE	Replacement of existing old BLA (MoF) and old TOM ATMs. Total ATM deployment timeline for 13500 = Z + 90 Days	This is extremely short Timeline. Request Bank to refer the replacement timeline based on latest TOM deployment project and extend the timeline to 1 year.	Terms & Conditions applicable as per RFP
286	5.2	Overall Rollout Plan details	Replacement of existing old BLA (MoF) and old TOM ATMs. (Z+90 )	We request bank to consider minimum Z +180 days.	Terms & Conditions applicable as per RFP
286	5.2.b.i	Overall rollout plan details	Site wise Bulk Purchase Order for replacement of old machines shall be issued by Anytime Channel Corporate Centre_ and penalty for delayed cash-live of services will be calculated from this Purchase Order date	Need to consider the delay attributable to bank, such as delay in TMKeys generation, Admin card etc..	Terms & Conditions applicable as per RFP
287	5.3	Tranche-wise Rollout Plan details	Replacement of existing old BLA (MoF) and old TOM ATMs	Rollout timeline is too stiff, request Bank to relook at deployment schedule.	Terms & Conditions applicable as per RFP



287	5.3-I	Tranche-wise Rollout Plan details:	Replacement of existing old BLA (MoF) and old TOM ATMs	As per table it is mentioned Z+30 for first 3000 count and so on till Z +90 days. In overall rollout plan it is mentioned as Z +90 days once the bulk PO is issued by Corporate center. Need clarity. Time lines to be increased as the number of ATMs to be deployed by all MSP is on higher side.	Terms & Conditions applicable as per RFP
289	7	MIS REPORTS:	Daily FOS report (Circle wise) Machine-ID wise FoS Report with details of cash dispensed, opening balance, cash replenished and cash evacuated.	> Request bank to share daily Feed file in bidder's file format with all basic mandatory fields like... Opening balance, closing balance, dispensation, cash increased, cash decreased, cash deposited, pre-replenishment % at denomination level for better forecast accuracy. > Bidder would not be able to meet bank's expectation to an extent in absence of feed file with all mandatory fields.	Terms & Conditions applicable as per RFP
290	1. (b)	COMMERCIAL BID FORMAT	Non-financial transaction rate: 25% of financial transaction rate	As per the RBI defined prevailing interchange rate, the non-financial transaction is costed at ~35% of financial transaction rate. We request the Bank to consider the same ratio for the commercials for non-financial transactions.	Terms & Conditions applicable as per RFP

290	1. (b)	COMMERCIAL BID FORMAT	No of financial tarnsactions: 150 No of non-financial transactions: 50	The proposed number of transactions is higher than the current portfolio level. Also considering the 7+3 years tenure assumptions of 200 transactions will not be practical considering the growth of digital payment channels. This will also lead to higher performance BG requirements for the bidder and impact liquidity. We request Bank to modify the following: No of financial tarnsactions: 120 No of non-financial transactions: 30	Terms & Conditions applicable as per RFP
290	Appendix-F	: INDICATIVE COMMERCIAL PRICE BID FORMATs Optional Services	External Digital Signage Solutions (EDSS) F = Financial E = 3% of A Non-Financial F = 3% of B	The Digital signage solutions are expensive compared to the regular signages. Therefore the Bidder requests the bank to revisit the fixed criteria of the prce being  Financial E = 30% of A Non-Financial F = 30% of B	<b>CORRIGENDUM:</b> External Digital Signage Solutions (EDSS) F = Financial E = <del>3</del> 5% of A Non-Financial F = <del>3</del> 5% of B

290	Appendix-F	Appendix-F: INDICATIVE COMMERCIAL PRICE BID FORMATS	TCO shall be calculated considering 150 (one hundred fifty) Successful Financial Transactions per ATM per day @ discovered rate i.e., "A" as per price bid and 50 (fifty) Non-Financial transactions @ derived rate per ATM per day from "A" (Fix 25% of "A") as per price bid i.e., "B" for 13,500 Offsite ATMs for 7 years (2557 Days).	The current trend of Transactions are going down. Request Bank to consider 100 Financial Txns and 25 Non-Financial transactions for TCO calculation and Bank guarantee working.	Terms & Conditions applicable as per RFP
290	Appendix-F	Appendix-F: INDICATIVE COMMERCIAL PRICE BID FORMATS	Note: 1. ₹ 0.00 Rate to be quoted by Bidder (excluding Tax) while submitting Commercial Bids. Reverse Auction will be carried out at item mentioned against "A" and "B"; however, "B" shall be fixed as 25% of "A". All other line items under Serial No. 2 shall be derived as mentioned above. Selected Vendors (L2 /L3 / L4 ...) have to	Reverse auction will be on TCO for 13500 ATMs OR per Financial transaction i.e. "A"	Terms & Conditions applicable as per RFP: Clarification: Please refer Appendix-F1.

			match all line items mentioned against A, B, C, D, E, F of L1.		
290	Appendix-F	F1- Price Bid Format	External Digital Signage Solutions (EDSS)	We request the bank to change the 3% of financial transaction to 9% of financial transaction as the signage cost is more than 2 lakhs based on the specs provided by the bank. 3% cost of financial transaction is not the real indication for the cost incurred to deeply and maintain the digital signage.	<b>CORRIGENDUM:</b> External Digital Signage Solutions (EDSS) F = Financial E = 3 5% of A Non-Financial F = 3 5% of B

293	Appendix-G	Certificate Local content	<p>This is to certify that proposed ATM model&lt;OEM &amp; model name&gt; has the local content of% as defined in the above-mentioned RFP and amendment thereto.</p>	<p>We request bank to consider the local content on the entire TCO as this is a services RFP and the local content calculation should not be done on only the ATM only.</p> <p>As per DPIIT circular of Sep 2020, the procurement is composite in nature and includes services, works and goods on a total outsourcing model based on per transaction rate. In this bid all assets belong to and remain the property of the bidder only. Also, at end of project this will remain the property of bidder.</p> <p>This is a services based per transaction opex model hence considering ATM for local content calculations is not correct. As bank also understands the cost of ATM with the TCO is around 5% hence considering only ATMs is not justified.</p> <p>Apart from ATMs, there are multiple other products required on the site and for servicing the customer for the next 7 years. Not considering</p>	<p>Terms &amp; Conditions applicable as per RFP</p>
-----	------------	---------------------------	--	--	---

those other products is also not justified.

We request the bank to consider the local content on TCO. We also request the bank to confer with DPIIT on the same as per the Sep 2020 policy and subsequent OMs and clarify to the bidders.

293	Appendix-G	Certificate of Local Content	<p>This is to certify that proposed ATM model</p> <p>_____</p> <p>&lt;OEM &amp; model name&gt; has the local content of _____ % as defined in the above-mentioned RFP and amendment thereto.</p>	Local content certificate need to be provided only for ATM, please confirm?	Terms & Conditions applicable as per RFP
296	FORMAT H1 FORMAT FOR EMD BANK GUARANTEE	FORMAT H1	<p>We undertake to pay the amount claimed by the SBI within 24 hours from the date of receipt of the notice as aforesaid. We confirm that our obligation to the SBI under this guarantee shall be independent of the agreement or agreements or other understandings between SBI and the Bidder. This guarantee shall not be revoked by us without prior consent in writing of the SBI.</p>	Requested Changes : Timeline should be increased to 7 days.	Terms & Conditions applicable as per RFP
302	Appendix I	Penalties and Incentives	Penalties and Incentives	This Appendix should be deleted since we suggest that no penalties be levied.	Terms & Conditions applicable as per RFP

303	1.3	Appendix-I - PENALTIES & INCENTIVES	<p>Computation of all penalties at the Local Head Office level. All penalties shall be recovered concurrently at the LHO level from the total bill payable to the Vendor for the particular month, subject to the maximum of 35% of the bill payable. This cap of 35% shall not be applicable on Actual loss to Bank, transition penalty, e-Surveillance penalty, EDSS Penalty, Housekeeping penalty and for such item's penalty can be charged and recovered from Vendor beyond 35%.</p>	<p>The proposed penalty is too high and unreasonable. We request Bank to cap the penalty at 7.5% of monthly billing of individual endpoint. We also request Bank to include e-Surveillance, EDSS, HSK as part of this capping. Penalty for e-surveillance should also be included in this capping. To clarify, the claim related to e-surveillance disputes will continue to be as per actuals.</p>	<p>Terms &amp; Conditions applicable as per RFP</p>
-----	-----	-------------------------------------	---	---	---



303	1.3	Appendix-I PENALTIES & INCENTIVES	Computation of all penalties at the Local Head Office level. All penalties shall be recovered concurrently at the LHO level from the total bill payable to the Vendor for the particular month, subject to the maximum of 35% of the bill payable. This cap of 35% shall not be applicable on Actual loss to Bank, transition penalty, e-Surveillance penalty, EDSS Penalty, Housekeeping penalty and for such item's penalty can be charged and recovered from Vendor beyond 35%.	Capping of penalty should be of 20% of bills payable for that particular Month	Terms & Conditions applicable as per RFP
-----	-----	--------------------------------------	--	--	--

303	1.8	Appendix-I - General penalties & Incentives	If the machine is not cash-live within 30 days at metro areas and 40 days at Rural / semi-Urban / Urban areas from the date of Purchase order placed by respective circles, and the reason for delay is not attributable to the Bank, the vendor will be liable to pay a penalty of Rs. 5,000/- per machine per day from	It should be 60 days for Offsite & 45 days for Onsite. Penalty should be capped maximum at 5000 per site overall & not per day basis.	<p><b>CORRIGENDUM:</b>          If the machine is not cash-live within 30 days at metro areas and 40 days at Rural / semi-Urban / Urban areas from the date of Purchase order placed by respective circles, and the reason for delay is not attributable to the Bank, the vendor will be liable to pay a penalty of <del>Rs. 5,000/-</del> ₹1,000/- per machine per day from 31<sup>st</sup> day for metro and urban / 41<sup>st</sup> day for other areas, which will be realized/recovered from the vendor from their invoices. In case of any delay due to Bank dependency, the vendor has to advice the same in writing along with the necessary proof mentioning the cause of delay.</p>
-----	-----	---	--	---	---

303	1.8	Appendix-I - PENALTIES & INCENTIVES	<p>If the machine is not cash-live within 30 days at metro areas and 40 days at Rural / semi-Urban / Urban areas from the date of Purchase order placed by respective circles, and the reason for delay is not attributable to the Bank, the vendor will be liable to pay a penalty of Rs. 5,000/- per machine per day from 31st day for metro and urban / 41st day for other areas, which will be realized/recovered from the vendor from their invoices. In case of any delay due to Bank dependency, the vendor has to advise the same in writing along with the necessary proof mentioning the cause of delay.</p>	<p>Request Bank to allow 30 days for Metro and 40 days for Rural / Semi-urban / Urban areas for ATM Cashlive from the date of Site approval by Bank's HO / LHO and <u>NOT</u> from the PO date.</p> <p>Also request Bank to consider penalty Rs 500/- per day</p>	<p><b>CORRIGENDUM:</b>          If the machine is not cash-live within 30 days at metro areas and 40 days at Rural / semi-Urban / Urban areas from the date of Purchase order placed by respective circles, and the reason for delay is not attributable to the Bank, the vendor will be liable to pay a penalty of <del>Rs. 5,000/-</del> ₹1,000/- per machine per day from 31<sup>st</sup> day for metro and urban / 41<sup>st</sup> day for other areas, which will be realized/recovered from the vendor from their invoices. In case of any delay due to Bank dependency, the vendor has to advice the same in writing along with the necessary proof mentioning the cause of delay.</p>
-----	-----	-------------------------------------	--	---	---

303	Appendix I	Penalties and Incentive	<p>Computation of all penalties at the Local Head Office level. All penalties shall be recovered concurrently at the LHO level from the total bill payable to the Vendor for the particular month, subject to the maximum of 35% of the bill payable. This cap of 35% shall not be applicable on Actual loss to Bank, transition penalty, e-Surveillance penalty, EDSS Penalty, Housekeeping penalty and for such item's penalty can be charged and recovered from Vendor beyond 35%.</p>	<p>As this is per transaction payment RFP service provider will anyways get hit if the machine is down and transactions are low. We request the Bank to keep only the penalty for over all availability and remove the incident based penalties</p>	<p>Terms &amp; Conditions applicable as per RFP</p>
-----	------------	-------------------------	---	---	---

303	Appendix I - 1.3	Appendix-I PENALTIES & INCENTIVES	<p>Computation of all penalties at the Local Head Office level. All penalties shall be recovered concurrently at the LHO level from the total bill payable to the Vendor for the particular month, subject to the maximum of 35% of the bill payable. This cap of 35% shall not be applicable on Actual loss to Bank, transition penalty, e-Surveillance penalty, EDSS Penalty, Housekeeping penalty and for such item's penalty can be charged and recovered from Vendor beyond 35%.</p>	<p>Penalty capping of 35% is too high, we request Bank to cap the penalty at 20% of the bill payable.</p>	<p>Terms &amp; Conditions applicable as per RFP</p>
-----	------------------	-----------------------------------	---	---	---

303	Appendix I-1	Appendix-I PENALTIES & INCENTIVES	All billings will be on monthly basis in arrears for each Circle and payment shall be made by the respective Circles. The Bank may opt for a Centralized Bill Payment approach from its Corporate Centre instead of Circles.	Request Bank to release the payments centrally from its Corporate Centre only.	Terms & Conditions applicable as per RFP
303	Appendix-I	Appendix-I PENALTIES & INCENTIVES	Computation of all penalties at the Local Head Office level. All penalties shall be recovered concurrently at the LHO level from the total bill payable to the Vendor for the particular month, subject to the maximum of 35% of the bill payable. This cap of 35% shall not be applicable on Actual loss to Bank, transition penalty, e-Surveillance penalty, EDSS Penalty, Housekeeping penalty and for such item's penalty can be	As MSPs will be investing entire capex and Revenue will be on per transaction basis hence they already have pressure to meet ROI. Request Bank to capped penalty at 10% of the monthly bill payable for overall billing including transition penalty, e-Surveillance penalty, EDSS penalty, Housekeeping penalty.	Terms & Conditions applicable as per RFP

			charged and recovered from Vendor beyond 35%.		
303	Appendix-I	Appendix-I PENALTIES & INCENTIVES	In case the penalties levied on the vendor are more than 35% in any Circle for a consecutive period of six months then the bank has the right to terminate the services of the vendor from that particular Circle.	The termination should be on mutually agreed basis as MSP has invested huge Capex for the Bank. On termination, Bank will be liable to pay pending books value of the Asset.	Terms & Conditions applicable as per RFP

303	Appendix-I	PENALTIES & INCENTIVES	<p>Computation of all penalties at the Local Head Office level. All penalties shall be recovered concurrently at the LHO level from the total bill payable to the Vendor for the particular month, subject to the maximum of 35% of the bill payable. This cap of 35% shall not be applicable on Actual loss to Bank, transition penalty, e-Surveillance penalty, EDSS Penalty, Housekeeping penalty and for such item's penalty can be charged and recovered from Vendor beyond 35%.</p>	very high capping slab	Terms & Conditions applicable as per RFP
-----	------------	------------------------	---	------------------------	--



303	Appendix-I	PENALTIES & INCENTIVES	<p>1.3. Computation of all penalties at the Local Head Office level. All penalties shall be recovered concurrently at the LHO level from the total bill payable to the Vendor for the particular month, subject to the maximum of 35% of the bill payable. This cap of 35% shall not be applicable on Actual loss to Bank, transition penalty, e-Surveillance penalty, EDSS Penalty, Housekeeping penalty and for such item's penalty can be charged and recovered from Vendor beyond 35%.</p>	<p>Penalty capping at 35% is very high. The Bidder requests the bank to keep the penalty capped at not more than 5% of the bill amount</p>	<p>Terms &amp; Conditions applicable as per RFP</p>
-----	------------	------------------------	--	--	---

303	Appendix-I - 1.3	GENERAL	<p>Computation of all penalties at the Local Head Office level. All penalties shall be recovered concurrently at the LHO level from the total bill payable to the Vendor for the particular month, subject to the maximum of 35% of the bill payable. This cap of 35% shall not be applicable on Actual loss to Bank, transition penalty, e-Surveillance penalty, EDSS Penalty, Housekeeping penalty and for such item's penalty can be charged and recovered from Vendor beyond 35%.</p>	<p>Request the Bank to Cap the overall penalty at 7% of the billing</p>	<p>Terms &amp; Conditions applicable as per RFP</p>
-----	------------------	---------	---	---	---

303	Appendix-I PENALTIES & INCENTIVES	Appendix-I PENALTIES & INCENTIVES	Appendix-I PENALTIES & INCENTIVES	We request the bank to cap the cumulative at 15% of the monthly site payment. The vendor is investing significant amount on this project so the penalty should not act as a deterrent.	Terms & Conditions applicable as per RFP
303	Appendix-I PENALTIES & INCENTIVES	Appendix-I PENALTIES & INCENTIVES	-	Requested Changes : Bank to provide a cure period in the circumstances mentioned in the clause before levying penalty on the Bidder. Further under no circumstance shall bank levy the penalty without the consent of the Bidder.	Terms & Conditions applicable as per RFP

303	Appendix-I PENALTIES & INCENTIVES 1. GENERAL:		1.3. Computation of all penalties at the Local Head Office level. All penalties shall be recovered concurrently at the LHO level from the total bill payable to the Vendor for the particular month, subject to the maximum of 35% of the bill payable. This cap of 35% shall not be applicable on Actual loss to Bank, transition penalty, e-Surveillance penalty, EDSS Penalty, Housekeeping penalty and for such item's penalty can be charged and recovered from Vendor beyond 35%.	Request the bank to cap penalties to 5% of the service payment. Cash loss can be kept at actuals.	Terms & Conditions applicable as per RFP
-----	--	--	---	---	--

303	Appendix-I PENALTIES & INCENTIVES 1. GENERAL:		1.10. Any penalty mentioned anywhere in this RFP / SLA, but not specifically mentioned in Appendix-I (Penalties & Incentives), shall also applicable and binding to the Vendor.	Request the bank to cap penalties to 5% of the service payment. Cash loss can be kept at actuals.	Terms & Conditions applicable as per RFP
-----	--	--	---	---	--

304	1.8	-	<p>If the machine is not cash-live within 30 days at metro areas and 40 days at Rural / semi-Urban / Urban areas from the date of Purchase order placed by respective circles, and the reason for delay is not attributable to the Bank, the vendor will be liable to pay a penalty of Rs. 5,000/- per machine per day from 31st day for metro and urban / 41st day for other areas, which will be realized/recovered from the vendor from their invoices. In case of any delay due to Bank dependency, the vendor has to advise the same in writing along with the necessary proof mentioning the cause of delay.</p>	<p>It should be 60 days for Offsite &amp; 45 days for Onsite. Penalty should be capped maximum at 5000 per site overall &amp; and not per day basis. If it's down due to the Bank then MSP would get paid for revenue loss</p>	<p><b>CORRIGENDUM:</b>          If the machine is not cash-live within 30 days at metro areas and 40 days at Rural / semi-Urban / Urban areas from the date of Purchase order placed by respective circles, and the reason for delay is not attributable to the Bank, the vendor will be liable to pay a penalty of <del>Rs. 5,000/-</del> ₹1,000/- per machine per day from 31<sup>st</sup> day for metro and urban / 41<sup>st</sup> day for other areas, which will be realized/recovered from the vendor from their invoices. In case of any delay due to Bank dependency, the vendor has to advice the same in writing along with the necessary proof mentioning the cause of delay.</p>
-----	-----	---	--	--	---

304	1.8	Appendix-I PENALTIES & INCENTIVES	<p>If the machine is not cash-live within 30 days at metro areas and 40 days at Rural / semi-Urban / Urban areas from the date of Purchase order placed by respective circles, and the reason for delay is not attributable to the Bank, the vendor will be liable to pay a penalty of Rs. 5,000/- per machine per day from 31st day for metro and urban / 41st day for other areas, which will be realized/recovered from the vendor from their invoices. In case of any delay due to Bank dependency, the vendor has to advise the same in writing along with the necessary proof mentioning the cause of delay.</p>	<p>Penalty of Rs. 5000/- per machine per day is very high. We would request Bank to reduce the penalty to Rs. 1000/- per machine per day.</p>	<p><b>CORRIGENDUM:</b>          If the machine is not cash-live within 30 days at metro areas and 40 days at Rural / semi-Urban / Urban areas from the date of Purchase order placed by respective circles, and the reason for delay is not attributable to the Bank, the vendor will be liable to pay a penalty of <del>Rs. 5,000/-</del> ₹1,000/- per machine per day from 31<sup>st</sup> day for metro and urban / 41<sup>st</sup> day for other areas, which will be realized/recovered from the vendor from their invoices. In case of any delay due to Bank dependency, the vendor has to advise the same in writing along with the necessary proof mentioning the cause of delay.</p>
-----	-----	-----------------------------------	--	---	---

304	1.8	Appendix-I PENALTIES & INCENTIVES	<p>If the machine is not cash-live within 30 days at metro areas and 40 days at Rural / semi-Urban / Urban areas from the date of Purchase order placed by respective circles, and the reason for delay is not attributable to the Bank, the vendor will be liable to pay a penalty of Rs. 5,000/- per machine per day from 31st day for metro and urban / 41st day for other areas, which will be realized/recovered from the vendor from their invoices. In case of any delay due to Bank dependency, the vendor has to advise the same in writing along with the necessary proof mentioning the cause of delay.</p>	<p>We request the Bank for considering these timelines (30 days for Metro and 40 days for Rural / Semi-urban) for ATM Cash live from the date of Site approval by Bank's HO / LHO and not from the date of purchase order.</p> <p>Also request Bank to reduce its penalty in a tune of Rs 1000/- per day, instead of Rs. 5000/-</p>	<p><b>CORRIGENDUM:</b> If the machine is not cash-live within 30 days at metro areas and 40 days at Rural / semi-Urban / Urban areas from the date of Purchase order placed by respective circles, and the reason for delay is not attributable to the Bank, the vendor will be liable to pay a penalty of <del>Rs. 5,000/-</del> <b>₹1,000/-</b> per machine per day from 31<sup>st</sup> day for metro and urban / 41<sup>st</sup> day for other areas, which will be realized/recovered from the vendor from their invoices. In case of any delay due to Bank dependency, the vendor has to advice the same in writing along with the necessary proof mentioning the cause of delay.</p>
-----	-----	--------------------------------------	--	---	---



304	1.8	Penalty and Incentives	<p>If the machine is not cash-live within 30 days at metro areas and 40 days at Rural / semi-Urban / Urban areas from the date of Purchase order placed by respective circles, and the reason for delay is not attributable to the Bank, the vendor will be liable to pay a penalty of Rs. 5,000/- per machine per day from 31st day for metro and urban / 41st day for other areas, which will be realized/recovered from the vendor from their invoices. In case of any delay due to Bank dependency, the vendor has to advise the same in writing along with the necessary proof mentioning the cause of delay.</p>	<p>We request bank to consider the TAT calculation from the time of site sourced and approved by Bank.</p>	<p><b>CORRIGENDUM:</b>          If the machine is not cash-live within 30 days at metro areas and 40 days at Rural / semi-Urban / Urban areas from the date of Purchase order placed by respective circles, and the reason for delay is not attributable to the Bank, the vendor will be liable to pay a penalty of <del>Rs. 5,000/-</del> ₹1,000/- per machine per day from 31<sup>st</sup> day for metro and urban / 41<sup>st</sup> day for other areas, which will be realized/recovered from the vendor from their invoices. In case of any delay due to Bank dependency, the vendor has to advice the same in writing along with the necessary proof mentioning the cause of delay.</p>
-----	-----	------------------------	--	--	---

304	Appendix-I	PENALTIES & INCENTIVES	<p>1.8. If the machine is not cash-live within 30 days at metro areas and 40 days at Rural / semi-Urban / Urban areas from the date of Purchase order placed by respective circles, and the reason for delay is not attributable to the Bank, the vendor will be liable to pay a penalty of Rs. 5,000/- per machine per day from 31st day for metro and urban / 41st day for other areas, which will be realized/recovered from the vendor from their invoices. In case of any delay due to Bank dependency, the vendor has to advise the same in writing along with the necessary proof mentioning the cause of delay</p>	<p>Bidder request bank to reduce penalty to @1000/day post above TAT , maximum to 5000/site for backlit signage locations. Digital signage required sites required 65 days TAT as lead time for digital signage installation at Semiurban or rural sites needs minimum 9 weeks. Here, Bidder request bank to consider 9-10 weeks TAT for Digital signage sites</p>	<p><b>CORRIGENDUM:</b> If the machine is not cash-live within 30 days at metro areas and 40 days at Rural / semi-Urban / Urban areas from the date of Purchase order placed by respective circles, and the reason for delay is not attributable to the Bank, the vendor will be liable to pay a penalty of <del>Rs. 5,000/-</del> ₹1,000/- per machine per day from 31<sup>st</sup> day for metro and urban / 41<sup>st</sup> day for other areas, which will be realized/recovered from the vendor from their invoices. In case of any delay due to Bank dependency, the vendor has to advice the same in writing along with the necessary proof mentioning the cause of delay.</p>
-----	------------	------------------------	--	--	--

304	Appendix-I - 1.8	GENERAL	<p>If the machine is not cash-live within 30 days at metro areas and 40 days at Rural / semi-Urban / Urban areas from the date of Purchase order placed by respective circles, and the reason for delay is not attributable to the Bank, the vendor will be liable to pay a penalty of Rs. 5,000/- per machine per day from 31st day for metro and urban / 41st day for other areas, which will be realized/recovered from the vendor from their invoices. In case of any delay due to Bank dependency, the vendor has to advice the same in writing along with the necessary proof mentioning the cause of delay.</p>	<p>Request the Bank to revise the Penalty as Rs 1000 per day</p>	<p><b>CORRIGENDUM:</b>  If the machine is not cash-live within 30 days at metro areas and 40 days at Rural / semi-Urban / Urban areas from the date of Purchase order placed by respective circles, and the reason for delay is not attributable to the Bank, the vendor will be liable to pay a penalty of <del>Rs. 5,000/-</del> ₹1,000/- per machine per day from 31<sup>st</sup> day for metro and urban / 41<sup>st</sup> day for other areas, which will be realized/recovered from the vendor from their invoices. In case of any delay due to Bank dependency, the vendor has to advice the same in writing along with the necessary proof mentioning the cause of delay.</p>
-----	------------------	---------	--	--	---

305	2.6	There will be no exclusion to availability, except force majeure and vandalism cases.	Bank related, Force Majeure to be specified, DR, Patch	We request bank , Any DR activity conducted by Bank has to be excluded from uptime calculation , Its observed that there are multiple activities in last 2-3 months of h 3-4hrs duration, Total impact on average >1% Downtime in last 3 months High power outages which are exhaust from Back up in many of LHO's like Lucknow, Patna , BBSR etc., Even full day scheduled power cut declared by Local EB Board which is beyond MSP Scope Network maintenance activity conducted by network providers Bank should consider sun outage downtime declared by VSAT providers Exclusions required for Force Majeure like rain , Flood, Transformer burnt, EB Pole issue, Voltage issue from EB Dept, Service Line disconnection, Curfew , Strike , Bandh etc. Onsite- Power , UPS , Access related issues during weekends in Bangalore , Bhopal, Maharashtra, BBSR, Patna Bank should consider exclusions of any Patch push activity instructed by GITC, Ref Moni version – 1-2% in last 1-2 months Bank should give	Terms & Conditions applicable as per RFP
-----	-----	---	--	---	--



exclusions for MHAAny Curfew , Access restrictions due to VIP or Govt visit at location to be considered Downtime of Any network migration activity from one vendor to another vendor to be excluded Bank should exclude the cases from penalty where cash was loaded as per the dispense pattern and Machine gets cast during festivals and cash not issued by bank on holidays/Festiva Bank renovation cases/shifting to be excluded from the penalty. Proper DB box should be made available for onsite/Branch site terminals to TOM sites (Separate Connection) so that issues can be addressed on a faster way and - Where ever power outage or power cuts are more bank should provide alternate Power source – DG/Solar etc. and the down should be excluded. Machines going down due to switch/BGL issues should be excluded from the down timebank approved ATM shifting of sites/ATMs should be excluded Any downtime on spare replacement- due to Branch

			power/earthing/Voltage to be Excluded	

305	2.7	PENALTIES & INCENTIVES	The endpoints have been classified into two different categories – VIP endpoints and Regular endpoints: VIP endpoints - Minimum targeted uptime 98% Regular endpoints - Minimum targeted uptime 96%	We request Bank to modify the minimum targeted uptime to following considering practical limitations: VIP endpoints - Minimum targeted uptime 97% Regular endpoints - Minimum targeted uptime 95%	<b>CORRIGENDUM:</b> The endpoints have been classified into two different categories – VIP endpoints and Regular endpoints: VIP endpoints - Minimum targeted uptime 98% Regular endpoints - Minimum targeted uptime <del>96%</del> 95%
305	2.8.	Penalty for not maintaining the target availability:	2.8.3. VIP endpoints  Availability Penalty Amount 95% to less than 98% 5% of Charges Payable 92% to less than 95% 10% of Charges Payable Less than 92% 25% of Charges Payable  2.8.4. Regular endpoints:  Availability Penalty Amount 93% to less than 96% 5% of Charges	Bank to consider revising the penalty terms to make the business more viable as the current penalties are too high. Also, Bidder here by request Bank to consider the below exclusions for the factors which are beyond MSP control: • Supervisory mode (up to 10Hrs per month for FLM, SLM, Maintenance & EOD activities) • In ability of bank's third party vendor to support or meet the SLA • Site not accessible for ATM servicing due to timing/access restrictions • Any downtime beyond the backup hours supported by UPS batteries. • Any ATM being shutdown on	<b>CORRIGENDUM:</b> 2.8.3. VIP endpoints Availability Penalty Amount 95% to less than 98% 5% of Charges Payable 92% to less than 95% 10% of Charges Payable Less than 92% 25% of Charges Payable  2.8.4. Regular endpoints: Availability Penalty Amount 93% to less than <del>96%</del> 95% 5% of Charges Payable 90 % to less than 93% 10% of Charges Payable Less than 90% 25% of Charges Payable

		<p><b>Payable</b>  <b>90 % to less than 93%</b>  <b>10% of Charges</b>  <b>Payable</b>  <b>Less than 90% 25% of</b>  <b>Charges Payable</b></p>	<p><b>daily basis on evening hrs</b></p> <ul style="list-style-type: none"> <li>• Downtime due to Software/MVS &amp; Other scheduled maintenance calls</li> <li>• Any Third party component failure where replacement required,</li> <li>• Power failure</li> <li>• software loading, MVS/Solid core issues.</li> <li>• Switch activity/failure,</li> <li>• Access availability issues</li> <li>• Downtime post operating hours as per the guidelines</li> <li>• Actual downtime due to cash out on account of delayed cash supply i.e., later than 12PM or non-supply of the cash by the Bank</li> <li>• Events of Force Majeure (Instances of force majeure, Vandalism and delays due to strikes, Bandh, Hartal, Political instability in the region (in such cases, the vendor shall inform and seek Bank's confirmation of its non-liability for penalty)</li> <li>• Core Banking solution host outages</li> <li>• Any downtime which are not attributable to MSP</li> <li>• Any other cause attributable to Bank's infrastructure</li> <li>• Faults which are not reported</li> </ul>	
--	--	---	--	--



			<p>through online Switch Feed. Bank Switch doesn't provide feeds for monitoring to Partner. Partner will intimate such instances within a reasonable time (20 min).</p> <ul style="list-style-type: none"><li>• Delay by the Bank in proving Terminal Master (TM) keys beyond 30 minutes from the partner engineer visits the site for site installation/servicing of CDs</li><li>• The cash out instances and resultant CD downtime will be excluded from the calculation of uptime if the ATM fit currency not provided by Bank to CITs</li><li>• Downtime due to NFS/issuing Bank network unavailability including but not limited to lease lines/LAN, host connectivity with the Switch or any other devices or due to the downtime of existing ATM leased line downtimes.</li><li>• Downtime due to scheduled maintenance of Bank's switch</li><li>• Downtime due to unavoidable delays for service personnel to reach the site on account of unavailability of public transport, road blocks, strikes, riots or natural</li></ul>	
--	--	--	---	--

				<p>calamities etc.,</p> <ul style="list-style-type: none"> <li>• Problems caused in rural areas or chronic power deficit area due to power cuts and improper switching OFF/ON of CD after the restoration of power</li> <li>• Downtime due to robbery attempt/vandalism at the site</li> <li>• Downtime caused due to any fraudulent activity which requires investigation.</li> </ul>	
305	2.8. Penalty for not maintaining the target availability:			Request the bank to cap penalties to 5% of the service payment. Cash loss can be kept at actuals.	Terms & Conditions applicable as per RFP

305	2.8.3	Appendix-I PENALTIES & INCENTIVES	<p><b>Uptime Penalties:</b>  <b>VIP Endpoints:</b>  95% to less than 98%- 5% of Charges Payable  92% to less than 95%- 10% of Charges Payable  Less than 92%- 25% of Charges Payable</p>	<p>Penalty is very high. We would request Bank to reduce the penalties as:  95% to less than 98%- 2% of Charges Payable  92% to less than 95%- 4% of Charges Payable  Less than 92%- 8% of Charges Payable</p>	<p><b>CORRIGENDUM:</b>  2.8.3. VIP endpoints Availability Penalty Amount  95% to less than 98% 5% of Charges Payable  92% to less than 95% 10% of Charges Payable  Less than 92% 25% of Charges Payable</p>
305	2.8.3	Appendix-I PENALTIES & INCENTIVES	<p><b>Uptime penalty</b>   <b>Regular ATM</b>  93% to 96% - 5% of monthly charges payable  90% to 93% - 10% of monthly charges payable  Less than 90% - 25% of monthly charges payable   <b>VIP ATM</b>  95% to 98% - 5% of monthly charges payable  92% to 95% - 10% of monthly charges payable  Less than 92% - 25% of monthly charges payable</p>	<p>The penalty here is too high, request bank to relook on this clause.</p>	<p><b>CORRIGENDUM:</b>  2.8.3. VIP endpoints Availability Penalty Amount  95% to less than 98% 5% of Charges Payable  92% to less than 95% 10% of Charges Payable  Less than 92% 25% of Charges Payable   2.8.4. Regular endpoints: Availability Penalty Amount  93% to less than <del>96%</del> <b>95%</b> 5% of Charges Payable  90 % to less than 93% 10% of Charges Payable  Less than 90% 25% of Charges Payable</p>

305	2.8.3	VIP endpoints	5%, 10%,and 25%	5%, 7% and 15%	<b>CORRIGENDUM:</b> 2.8.3. VIP endpoints Availability Penalty Amount 95% to less than <del>98%</del> <b>97%</b> 5% of Charges Payable 92% to less than 95% 10% of Charges Payable Less than 92% 25% of Charges Payable
305	2.8.3.	VIP endpoints	Availability Penalty Amount 95% to less than 98% 5% of Charges Payable 92% to less than 95% 10% of Charges Payable Less than 92% 25% of Charges Payable	Requesting Bank to revise this penalty, Bidder is suggesting Bank to make it 95%-98% - 3% 92%-95% - 5% Less than 92% - 10%	<b>CORRIGENDUM:</b> 2.8.3. VIP endpoints Availability Penalty Amount 95% to less than 98% 5% of Charges Payable 92% to less than 95% 10% of Charges Payable Less than 92% 25% of Charges Payable
305	2.8.4	Appendix-I PENALTIES & INCENTIVES	Uptime Penalties: Regular Endpoints: 93% to less than 96%- 5% of Charges Payable 90% to less than 93%- 10% of Charges Payable Less than 90%- 25% of Charges Payable	Penalty is very high. We would request Bank to reduce the penalties as: 93% to less than 96%- 2% of Charges Payable 90% to less than 93%- 4% of Charges Payable Less than 90%- 8% of Charges Payable	<b>CORRIGENDUM:</b> Regular ATM 93% to <del>96%</del> <b>95%</b> - 5% of monthly charges payable 90% to 93% - 10% of monthly charges payable Less than 90% - 25% of monthly charges payable

305	2.8.4	PENALTIES & INCENTIVES	Regular Endpoints: Availability: 93% to less than 96% - 5% of charges payable Availability: 90% to less than 93% - 10% of charges payable Availability: less than 90% - 25% of charges payable	The stipulated penalty is way too high. We request the Bank to reduce the penalty slabs for Regular Endpoints to the following: Availability: 93% to less than 96% - 2% of charges payable Availability: 90% to less than 93% - 4% of charges payable Availability: less than 90% - 7% of charges payable	<b>CORRIGENDUM:</b> Regular ATM 93% to <del>96%</del> 95% - 5% of monthly charges payable 90% to 93% - 10% of monthly charges payable Less than 90% - 25% of monthly charges payable
305	2.8.4	Regular endpoints	5%, 10%,and 25%	5%, 7% and 15%	<b>CORRIGENDUM:</b> Regular ATM 93% to <del>96%</del> 95% - 5% of monthly charges payable 90% to 93% - 10% of monthly charges payable Less than 90% - 25% of monthly charges payable
305	2.8.4.	Regular endpoints:	Availability Penalty Amount 93% to less than 96% 5% of Charges Payable 90 % to less than 93% 10% of Charges Payable Less than 90% 25% of Charges Payable	Requesting Bank to re-looked this penalty, Bidder is suggesting Bank to make it 93%-96% - 3% 90%-93% - 5% Less than 90% - 10%	<b>CORRIGENDUM:</b> Regular ATM 93% to <del>96%</del> 95% - 5% of monthly charges payable 90% to 93% - 10% of monthly charges payable Less than 90% - 25% of monthly charges payable

305	Appendix-I - 2.8.3	Penalty for not maintaining the target availability: VIP endpoints	Availability Penalty Amount - VIP 95% to less than 98% 5% of Charges Payable 92% to less than 95% 10% of Charges Payable Less than 92% 25% of Charges Payable	Request Bank to revise the penalty clause as below Availability Penalty Amount - VIP 95% to less than 98% 3% of Charges Payable 92% to less than 95% 5% of Charges Payable Less than 92% 15% of Charges Payable	<b>CORRIGENDUM:</b> VIP ATM 95% to 98% - 5% of monthly charges payable 92% to 95% - 10% of monthly charges payable Less than 92% - 25% of monthly charges payable
305	Appendix-I - 2.8.4	Penalty for not maintaining the target availability: Regular endpoints:	Availability Penalty Amount - Regular end points 93% to less than 96% 5% of Charges Payable 90 % to less than 93% 10% of Charges Payable Less than 90% 25% of Charges Payable	Request Bank to revise the penalty clause as below Availability Penalty Amount - Regular end points 93% to less than 96% 3% of Charges Payable 90 % to less than 93% 5% of Charges Payable Less than 90% 15% of Charges Payable	<b>CORRIGENDUM:</b> Regular ATM 93% to <del>96%</del> 95% - 5% of monthly charges payable 90% to 93% - 10% of monthly charges payable Less than 90% - 25% of monthly charges payable
307	3	MANAGED SERVICES	VIP ATM 2 Hours: Irrespective of the population group/ category. Rs 1,200/- per endpoint per hour.	Very high penalty, it should be per day	<b>CORRIGENDUM:</b> VIP ATM-2 4 Hours: Irrespective of the population group/ category. Rs <del>1,200/-</del> ₹500/- per endpoint per hour.

307	3	MANAGED SERVICES:	Category Resolution Time / TAT Penalty VIP ATMs 2 Hours: Irrespective of the population group / category Rs. 1200/- per endpoint per hour.	The Bidder requesting Bank to remove the resolution TAT penalties since the uptime penalties are already in place	<b>CORRIGENDUM:</b> VIP ATM-2 4 Hours: Irrespective of the population group/ category. <del>Rs 1,200/-</del> ₹500/- per endpoint per hour.
307	<del>2.9.3</del> 3.1	Regular Endpoints- MANAGED SERVICES	i. 4 Hours: At Metro, Urban, and Semi-urban locations, ii. 6 Hours: At Rural locations- 1000/- per endpoint per hour	We request bank , 1000rs penalties for more than 4hrs cases to be removed as downtime penalties are already moved to <87 to <90 and all these will cover under downtime penalties	<b>CORRIGENDUM</b> Regular ATMs i. 4- 6 Hours: At Metro, Urban, and Semi-urban locations, ii. 6 8 Hours: At Rural locations <del>Rs.1000/-</del> ₹200/- per endpoint per hour.
307	3. MANAGED SERVICES:	3. MANAGED SERVICES:	VIP ATMs - 2 Hours: Irrespective of the population group / category - Rs. 1200/- per endpoint per hour. Regular ATMs - i. 4 Hours: At Metro, Urban and Semi-urban locations ii. 6 Hours: At Rural locations - Rs. 1000/- per endpoint per hour.	Penalties are too high. We request for below penalties. VIP ATMs - 2 Hours: Irrespective of the population group / category - Rs. 500/- per endpoint per hour. Regular ATMs - i. 4 Hours: At Metro, Urban and Semi-urban locations ii. 6 Hours: At Rural locations - Rs. 300/- per endpoint per hour.	<b>CORRIGENDUM:</b> VIP ATM-2 4 Hours: Irrespective of the population group/ category. <del>Rs 1,200/-</del> ₹500/- per endpoint per hour. Regular ATMs i. 4- 6 Hours: At Metro, Urban, and Semi-urban locations, ii.-6 8 Hours: At Rural locations <del>Rs.1000/-</del> ₹200/- per endpoint per hour.

307	3. MANAGED SERVICES:			Request the bank to cap penalties to 5% of the service payment. Cash loss can be kept at actuals.	Terms & Conditions applicable as per RFP
308	3.1	MANAGED SERVICES:	Regular ATMs, 4 Hours: At Metro, Urban and Semi-urban locations. Rs 1,000/- per endpoint per hour.	Very high penalty, it should be per day	<b>CORRIGENDUM:</b> VIP ATM- <del>2</del> 4 Hours: Irrespective of the population group/ category. <del>Rs 1,200/-</del> ₹500/- per endpoint per hour. Regular ATMs i. <del>4</del> 6 Hours: At Metro, Urban, and Semi-urban locations, ii. <del>6</del> 8 Hours: At Rural locations <del>Rs.1000/-</del> ₹200/- per endpoint per hour.
308	3. MANAGED SERVICES:	Housekeeping	3.2.3. Penalty shall be levied if ATM/ site / allied equipment(s) is not maintained clean and in proper condition. The penalty shall be levied for each instance reported by Channel Manager / Bank official / e-Surveillance / any customer / social media / any complaint etc.	Request Bank to consider following Penalties VIP ATMs - Rs.500/- per site per instance Regular ATMs - Rs.300/- per site per instance	<b>CORRIGENDUM:</b> Category Penalty VIP ATMs <del>Rs.3,000/-</del> ₹750/- per site per instance Regular ATMs <del>Rs.2,000/-</del> ₹500/- per site per instance



308	3. MANAGED SERVICES:	Housekeeping	3.2.5. An additional penalty of Rs. 5,000/- per site per month shall be levied if Vendor receives more than 2 recorded complaints from the Bank for that particular site in the particular month, pertaining to unsatisfactory maintenance, upkeep and general cleaning of the sites.	Request Bank to remove an additional penalty as the Bank is already charging on per instance to the vendor.	<b>CORRIGENDUM:</b> 3.2.5. An additional penalty of <del>Rs. 5,000/-</del> <b>₹1,000/-</b> per site per month shall be levied if Vendor receives more than 2 recorded complaints from the Bank for that particular site in the particular month, pertaining to unsatisfactory maintenance, upkeep and general cleaning of the sites. It will be the responsibility of the vendor to submit a daily report to the concerned Circles and the Channel Managers of the respective endpoint.
308	3.2.	housekeeping	VIP ATMs Rs.3,000/- per site per instance / Regular ATMs Rs.2,000/- per site per instance	Bank to consider revising the penalty terms to make the business more viable as the current penalties are too high Bidder requested Bank to consider below VIP ATMs - 500 Regular ATMs - 100	<b>CORRIGENDUM:</b> Category Penalty VIP ATMs <del>Rs.3,000/-</del> <b>₹750/-</b> per site per instance Regular ATMs <del>Rs.2,000/-</del> <b>₹500/-</b> per site per instance
308	3.2. housekeeping:			Request the bank to cap penalties to 5% of the service payment. Cash loss can be kept at actuals.	Terms & Conditions applicable as per RFP
308	3.2.3	Appendix-I PENALTIES & INCENTIVES	House keeping penalty: VIP ATMs: Rs. 3000/- per site per instance Regular ATMs: Rs.	Penalty is very high. We would request Bank to reduce this penalty to Rs. 200 per site per instance with a maximum penalty cap of Rs. 1000 per site in a month	<b>CORRIGENDUM:</b> Category Penalty VIP ATMs <del>Rs.3,000/-</del> <b>₹750/-</b> per site per instance Regular ATMs <del>Rs.2,000/-</del> <b>₹500/-</b> per site per instance

			2000/- per site per instance												
308	3.2.3	House keeping Penalty	<p>Penalty shall be levied if ATM/ site / allied equipment(s) is not maintained clean and in proper condition. The penalty shall be levied for each instance reported by Channel Manager / Bank official / e-Surveillance / any customer / social media / any complaint etc., as under:</p> <p>VIP ATMs Rs.3,000/- per site per instance Regular ATMs Rs.2,000/- per site per instance</p>	Request Bank to fix the Penalty not beyond 5% of the Monthly House keeping charges for the said site.	<p><b>CORRIGENDUM:</b></p> <table> <thead> <tr> <th>Category</th> <th>Penalty</th> </tr> </thead> <tbody> <tr> <td>VIP ATMs</td> <td><del>Rs.3,000/-</del> ₹750/-</td> </tr> <tr> <td>per site</td> <td>per instance</td> </tr> <tr> <td>Regular ATMs</td> <td><del>Rs.2,000/-</del></td> </tr> <tr> <td>₹500/-</td> <td>per site per instance</td> </tr> </tbody> </table>	Category	Penalty	VIP ATMs	<del>Rs.3,000/-</del> ₹750/-	per site	per instance	Regular ATMs	<del>Rs.2,000/-</del>	₹500/-	per site per instance
Category	Penalty														
VIP ATMs	<del>Rs.3,000/-</del> ₹750/-														
per site	per instance														
Regular ATMs	<del>Rs.2,000/-</del>														
₹500/-	per site per instance														

308	3.2.5	Appendix-I Penalties And Incentives	An additional penalty of Rs. 5,000/- per site per month shall be levied if Vendor receives more than 2 recorded complaints from the Bank for that particular site in the particular month, pertaining to unsatisfactory maintenance, upkeep and general cleaning of the sites. It will be the responsibility of the vendor to submit a daily report to the concerned Circles and the Channel Managers of the respective endpoint.	The stipulated penalty is way too high. We request the Bank to reduce the penalty amount be at Rs. 500/- per site per month if the vendor receives more than 2 recorded complaints	<b>CORRIGENDUM:</b> 3.2.5. An additional penalty of <del>Rs. 5,000/-</del> <b>₹1,000/-</b> per site per month shall be levied if Vendor receives more than 2 recorded complaints from the Bank for that particular site in the particular month, pertaining to unsatisfactory maintenance, upkeep and general cleaning of the sites. It will be the responsibility of the vendor to submit a daily report to the concerned Circles and the Channel Managers of the respective endpoint.
-----	-------	--	---	--	--

308	3.2.housekeeping	housekeeping	3.2.5. An additional penalty of Rs. 5,000/- per site per month shall be levied if Vendor receives more than 2 recorded complaints from the Bank for that particular site in the particular month, pertaining to unsatisfactory maintenance, upkeep and general cleaning of the sites. It will be the responsibility of the vendor to submit a daily report to the concerned Circles and the Channel Managers of the respective endpoint.	Bank to consider revising the penalty terms to make the business more viable as the current penalties are too high Bidder requesting Bank to keep the same 1000/-	<b>CORRIGENDUM:</b> 3.2.5. An additional penalty of <del>Rs. 5,000/-</del> <b>₹1,000/-</b> per site per month shall be levied if Vendor receives more than 2 recorded complaints from the Bank for that particular site in the particular month, pertaining to unsatisfactory maintenance, upkeep and general cleaning of the sites. It will be the responsibility of the vendor to submit a daily report to the concerned Circles and the Channel Managers of the respective endpoint.
308	3.3. consumables :			Request the bank to cap penalties to 5% of the service payment. Cash loss can be kept at actuals.	Terms & Conditions applicable as per RFP

309	3.3.	consumables:	3.3.3. Penalty @ Rs.1000/- per incident shall be levied if consumables are not made available within four hour from the time information available in Online Monitoring Tools or complaint lodged by Bank official at the portal and/ or advised by Channel Manager or by the Bank official in this regard. The consumables required are to be replaced by the vendor at the respective machines.	Bidder requesting Bank to reduce this penalty 100 per incident also the TAT to be revise to 12 Hours	<b>CORRIGENDUM:</b> Penalty @ <del>Rs.1000/-</del> ₹100/- per incident shall be levied if consumables are not made available within four hour from the time information available in Online Monitoring Tools or complaint lodged by Bank official at the portal and/ or advised by Channel Manager or by the Bank official in this regard. The consumables required are to be replaced by the vendor at the respective machines.
309	3.3.3	Consumables	. Penalty @ Rs.1000/- per incident shall be levied if consumables are not made available within four hour from the time information available in Online Monitoring Tools or complaint lodged by Bank official at the portal and/ or advised by Channel Manager or by the Bank official in this regard. T	Request Bank to fix the Penalty not beyond 5% of the Monthly Consumables charges for the said site.	<b>CORRIGENDUM:</b> Penalty @ <del>Rs.1000/-</del> ₹100/- per incident shall be levied if consumables are not made available within four hour from the time information available in Online Monitoring Tools or complaint lodged by Bank official at the portal and/ or advised by Channel Manager or by the Bank official in this regard. The consumables required are to be replaced by the vendor at the respective machines.

309	3.3.3	Penalty	<p>Penalty @ Rs.1000/- per incident shall be levied if consumables are not made available within four hour from the time information available in Online Monitoring Tools or complaint lodged by Bank official at the portal and/ or advised by Channel Manager or by the Bank official in this regard. The consumables required are to be replaced by the vendor at the respective machines</p>	<p>We request bank to cap the penalty to Rs 100 per incident of delay.</p>	<p><b>CORRIGENDUM:</b>  Penalty @ <del>Rs.1000/-</del> ₹100/- per incident shall be levied if consumables are not made available within four hour from the time information available in Online Monitoring Tools or complaint lodged by Bank official at the portal and/ or advised by Channel Manager or by the Bank official in this regard. The consumables required are to be replaced by the vendor at the respective machines.</p>
-----	-------	---------	--	--	--

309	3.3.3.	consumables	Penalty @ Rs.1000/- per incident shall be levied if consumables are not made available within four hour from the time information available in Online Monitoring Tools or complaint lodged by Bank official at the portal and/ or advised by Channel Manager or by the Bank official in this regard. The consumables required are to be replaced by the vendor at the respective machines	Rs. 100	<b>CORRIGENDUM:</b> Penalty @ <del>Rs.1000/-</del> ₹100/- per incident shall be levied if consumables are not made available within four hour from the time information available in Online Monitoring Tools or complaint lodged by Bank official at the portal and/ or advised by Channel Manager or by the Bank official in this regard. The consumables required are to be replaced by the vendor at the respective machines.
309	3.4.	CASH MANAGEMENT:	Penalty for not maintaining target FoS:	FOS need to be increase by 2 days or Make it MTD	Terms & Conditions applicable as per RFP
309	3.4. CASH MANAGEMEN T:		3.4.1.5. If FoS is more than 2 or 2.5 as mentioned above, then interest @ prevailing SBI Clean Overdraft rate will be levied on the excess cash found above the prescribed norm.	This means daily replenishment even for cassette swap model to avoid penalty. Wear and tear of cassette will be on higher side and also sorting charges will be higher side if applicable. Kindly do not implement daily EOD for cassette swap ATMs. It is practically not feasible.	Terms & Conditions applicable as per RFP

309	3.4. CASH MANAGEMENT: NT:		3.4.1.3. FoS will be calculated on Daily basis at every individual Endpoint level (except days prior to the Bank Holiday).	Network level can be balanced but at the individual ATM FOS to be maintained will be very difficult. Request the bank to reconsider.	Terms & Conditions applicable as per RFP
309	3.4. CASH MANAGEMENT: NT:		3.4.1.7. The Vendor shall not hold or retain in their vault more than 15% of the total cash taken from Bank on monthly basis. If the retention is more than 15%, a penalty @ prevailing SBI clean overdraft rate per annum shall be levied on the excess cash retained in the vault during the month.	This is not feasible in case of cassette swap, need to hold 100% cash for cassette swap ATMs. Kindly allow this.	Terms & Conditions applicable as per RFP



309	3.4.1	Penalty for not maintaining target FoS:	<p>FoS will be calculated on Daily basis at every individual Endpoint level (except days prior to the Bank Holiday).</p> <p>If FoS is more than 2 or 2.5 as mentioned above, then interest @ prevailing SBI Clean Overdraft rate will be levied on the excess cash found above the prescribed norm.</p>	<p>FOS needs to be calculated on the network cash &amp; not on ATM wise daily dispense data. Reasons are mentioned below.</p> <ol style="list-style-type: none"> <li>1. If ATM is down due to FLM/SLM/Network/power etc issues &amp; if bank calculating FOS on daily ATM wise switch dispense, then we always get penalty for FOS because at any point of time number of ATMs are always down in different categories plus downtime penalty.</li> <li>2. Bank has to calculate considering CRA feasibility days, hence the FOS for those sites of 2 days is not practical.</li> <li>3. Weekend FOS is only 2.5 days which is not sufficient till Monday, many number of ATMs will go out of cash.</li> <li>4. Cash Forecasting is totally based on historical data, dispense can change based on the different ground conditions, hence dispense is always fluctuate.</li> <li>5. As per industry standards given below is the formula of FOS</li> </ol> <p>FOS can be calculate on cutover</p>	Terms & Conditions applicable as per RFP
-----	-------	---	---	--	--

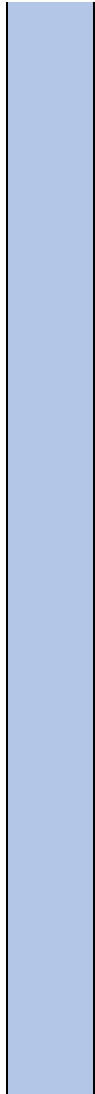

file balance i.e of 12 AM  
divided by the previous day  
dispense.

309	3.4.1.1	Factor of Safety (FoS)''	Factor of Safety (FoS)'',	FOS should be calculated as per new formula (i.e. Closing Balance / Avg dispense of previous month(salary / non salary) and should be 3 for normal days and 4 for weekend	Terms & Conditions applicable as per RFP
309	3.4.1.2	CASH MANAGEMENT	FoS will be fixed at 2.0	FOS of 2.0 is difficult to achieve given the geographical spread and limited CRA infrastructure. We request Bank to modify regular FOS at 2.5. FOS needs to be increased by 1 for every holiday. This need to be reviewed on every fortnightly basis.	Terms & Conditions applicable as per RFP
309	3.4.1.2	Penalty for not maintaining target FoS:	3.4.1.2. FoS will be fixed at 2.0 i.e., for every Rs.100 Cash withdrawn, there should be upto Rs. 200 cash available in the ATM. For illustration, it can be calculated as follows: [Opening cash in the ATM + Amount of cash replenished] ----- ----- ----- = 2 Net cash withdrawn by customer during the day.	3.4.1.2. FoS will be fixed at 3.0 i.e., for every Rs.100 Cash withdrawn, there should be upto Rs. 300 cash available in the ATM. For illustration, it can be calculated as follows: [Opening cash in the ATM + Amount of cash replenished] ----- ----- = 3 Average Net cash withdrawn by customer during time of the week.	Terms & Conditions applicable as per RFP

309	3.4.1.2 & 3.4.1.7	CASH MANAGEMENT	<p>FoS will be fixed at 2.0 i.e., for every Rs.100 Cash withdrawn, there should be upto Rs. 200 cash available in the ATM. For illustration, it can be calculated as follows: [Opening cash in the ATM + Amount of cash replenished] ----- ----- ----- = 2</p> <p>Net cash withdrawn by customer during the day</p> <p>3.4.1.7. The Vendor shall not hold or retain in their vault more than 15% of the total cash taken from Bank on monthly basis. If the retention is more than 15%, a penalty @ prevailing SBI clean overdraft rate per annum shall be levied on the excess cash</p>	<ul style="list-style-type: none"> <li>&gt; Bidder requests the bank to consider Opening / dispense as the FOS formula</li> <li>&gt; FOS &amp; cash out are internconnented with each other, reduction in FOS may increase cash out instances and therefore to maintain targated FOS, even nominal variation in dispensation may lead to cash out so bidder shouldn't be liable for excess/high/variation in dispensation.</li> <li>&gt; Penalty excess cash and for vault both is too high, would request to reduce same.</li> <li>&gt; The excess cash penalty in vault should be applicable for utilized cash, means cash which bidder fails to utilize/replenish on Sunday/holiday.</li> <li>&gt; Also relaxation needed for site where cash couldn't be able to load due to technical dependencies &amp; also non-operational machines.</li> <li>&gt; It is not possible to dispatch routes with 15% of cash in vault, partial routes can't be dispatch thus would request to revoke this equation.</li> </ul>	Terms & Conditions applicable as per RFP
-----	----------------------	-----------------	--	---	--

		retained in the vault during the month		
--	--	---	--	--

309	3.4.1.3	Factor of Safety (FoS)''	FoS will be calculated on Daily basis at every individual Endpoint level (except days prior to the Bank Holiday).	FOS Should be calculated based on network cash .	Terms & Conditions applicable as per RFP
309	3.4.1.3	Penalty for not maintaining target FoS:	3.4.1.3. FoS will be calculated on Daily basis at every individual Endpoint level (except days prior to the Bank Holiday).	Request bank to change 3.4.1.3. FoS will be calculated on monthly basis at every individual Endpoint level (except days prior to the Bank Holiday).	Terms & Conditions applicable as per RFP
309	3.4.1.5	Penalty for not maintaining target FoS:	ATM. 3.4.1.5. If FoS is more than 2 or 2.5 as mentioned above, then interest @ prevailing SBI Clean Overdraft rate will be levied on the excess cash found above the prescribed norm	Bank needs to evaluate and change the computation of this penalty	Terms & Conditions applicable as per RFP
309	3.4.1.6.	Penalty for not maintaining target FoS:	Excess cash = opening balance + cash replenished - Ideal cash;where Ideal cash = Average Cash dispensed * Target FoS	This is not as per the changed proposed in Addendum for TOM 14. Cash replenished is not considered as per new suggested clause. We request bank to consider the new addendum proposed.	<b>CORRIGENDUM:</b> Excess cash = <del>opening balance</del> + <del>cash replenished</del> closing balance - Ideal cash; where Ideal cash = <del>Average Cash dispensed</del> * Average Daily withdrawal of previous month x Target FoS

309	Appendix-I - 3.3.3	3.3.consumables:	Penalty @ Rs.1000/- per incident shall be levied if consumables are not made available within four hour from the time information available in Online Monitoring Tools or complaint lodged by Bank official at the portal and/ or advised by Channel Manager or by the Bank official in this regard. The consumables required are to be replaced by the vendor at the respective machines	Need clarity, as due to RP machine is not down and impact on transaction. Request the bank to be delete the clause.	<b>CORRIGENDUM:</b> Penalty @ <del>Rs.1000/-</del> ₹100/- per incident shall be levied if consumables are not made available within four hour from the time information available in Online Monitoring Tools or complaint lodged by Bank official at the portal and/ or advised by Channel Manager or by the Bank official in this regard. The consumables required are to be replaced by the vendor at the respective machines.
310	3. MANAGED SERVICES:	Cash Management	3.4.1.7. The Vendor shall not hold or retain in their vault more than 15% of the total cash taken from Bank on monthly basis. If the retention is more than 15%, a penalty @ prevailing SBI clean overdraft rate per annum shall be levied on the excess cash retained in the vault during the month.	In Cassette swap, the return cash volume will be high if any ATM goes down. Hence less capping in vaulting cash is not viable.	Terms & Conditions applicable as per RFP

310	3.4.	CASH MANAGEMENT:	<p>3.4.1.10. In each Endpoint, replenishment / Evacuation of cash shall ordinarily be done once a day. In case the number of cash replenishment / evacuation is less than 15 days in a month, penalty @ Rs. 1,500/- for each day default for non-compliance of cash replenishment shall be imposed. This penalty shall be in addition to Cash out and other penalties as prescribed elsewhere in this RFP. However, Bank reserves the right to increase the number of Cash replenishment / Cash Evacuation days in a month at its sole discretion, as and when required, without any additional cost to the Bank.</p>	Bidder requesting Bank to only consider RBI penalties	Terms & Conditions applicable as per RFP
-----	------	------------------	---	---	--



310	3.4. CASH MANAGEMENT: NT:		3.4.1.10. In each Endpoint, replenishment / Evacuation of cash shall ordinarily be done once a day. In case the number of cash replenishment / evacuation is less than 15 days in a month, penalty @ Rs. 1,500/- for each day default for non-compliance of cash replenishment shall be imposed. This penalty shall be in addition to Cash out and other penalties as prescribed elsewhere in this RFP. However, Bank reserves the right to increase the number of Cash replenishment / Cash Evacuation days in a month at its sole discretion, as and when required, without any additional cost to the Bank.	Cassette swap 15 loads in a month means almost daily attempt. Wear and tear of cassette will be on higher side. For ADD cash & cassette swap there will be exceptional cases where replenishment / evacuation cannot be carried out i.e. ATM down, not accessible, vandalism case, power, theft, authority restriction ,CIT feasibility depending on location etc	Terms & Conditions applicable as per RFP
-----	---------------------------------	--	--	---	--

310	3.4. CASH MANAGEMENT:		3.4.1.11. Delay in EOD activity of endpoints as define in this RFP may result in reconciliation arrears. Penalty of Rs.100/- per day per endpoint for delay in EOD shall be levied.	need clarity on delay.	Terms & Conditions applicable as per RFP
310	3.4.1.10	Factor of Safety (FoS)''	In each Endpoint, replenishment / Evacuation of cash shall ordinarily be done once a day. In case the number of cash replenishment / evacuation is less than 15 days in a month, penalty	There Should be exclusion given to long distance ATMS with limited feasibility instated of only loading , CRA EOD visit should also be considered minimum 12 visit to be considered	Terms & Conditions applicable as per RFP
310	3.4.1.10	Penalty for not maintaining target FoS:	In each Endpoint, replenishment / Evacuation of cash shall ordinarily be done once a day. In case the number of cash replenishment / evacuation is less than 15 days in a month, penalty @ Rs. 1,500/- for each day default for non-compliance of cash replenishment shall be imposed.	No Penalty Acceptable for this. For non cassettes swap 12 EOD/ Loading & 10 for Cassettes swap ATMs	Terms & Conditions applicable as per RFP

310	3.4.1.10.	FoS	<p>In each Endpoint, replenishment / Evacuation of cash shall ordinarily be done once a day. In case the number of cash replenishment / evacuation is less than 15 days in a month, penalty @ Rs. 1,500/- for each day default for non-compliance of cash replenishment shall be imposed. This penalty shall be in addition to Cash out and other penalties as prescribed elsewhere in this RFP. However, Bank reserves the right to increase the number of Cash replenishment / Cash Evacuation days in a month at its sole discretion, as and when required, without any additional cost to the Bank.</p>	<p>We request bank the cash loading count depend on site feasibility study. We request bank to consider the loading based on feasibility report.</p> <p>Example :- Some sites are feasible for more then 15 loading and some are feasible for less then 15 loading.</p> <p>So we request bank to impose penalty based on feasibility finalized mutually between bank and vendor</p>	<p>Terms &amp; Conditions applicable as per RFP</p>
-----	-----------	-----	---	---	---

310	3.4.1.11	CASH MANAGEMENT	Delay in EOD activity of endpoints as define in this RFP may result in reconciliation arrears. Penalty of Rs.100/- per day per endpoint for delay in EOD shall be levied.	<p>1. There should be relaxation for uncontrollable factors, natural disasters &amp; also there could be possibility of loading/EOD skip by bidder/CRA due to abnormal/uncontrollable situation like riots, force meajure, far offsites, transportations, area power failure, SLM bank dependency, access restriction, captive sites, ATM down at the time of loading etc.</p> <p>2. Far offsite machine, where replenishment couldn't be possible daily, bidder can share such list.</p>	Terms & Conditions applicable as per RFP
310	3.4.1.11	EOD	Delay in EOD activity of endpoints as define in this RFP may result in reconciliation arrears. Penalty of Rs.100/- per day per endpoint for delay in EOD shall be levied	EOD will be carried out daily only if there is loading as in Cassette swap method one cant open the cassettes at site.	Terms & Conditions applicable as per RFP

310	3.4.1.11.	Delay in EOD activity of endpoints as define in this RFP may result in reconciliation arrears. Penalty of Rs.100/- per day per endpoint for delay in EOD shall be levied.	Delay in EOD activity of endpoints as define in this RFP may result in reconciliation arrears. Penalty of Rs.100/- per day per endpoint for delay in EOD shall be levied.	We request bank to remove this penalty clause as bank already covered penalty for not loading the cash	Terms & Conditions applicable as per RFP
310	3.4.1.11.	FoS	Delay in EOD activity of endpoints as define in this RFP may result in reconciliation arrears. Penalty of Rs.100/- per day per endpoint for delay in EOD shall be levied.	We request bank to remove this penalty clause as this is already covered under 3.4.1.10 penalty clause.	Terms & Conditions applicable as per RFP
310	3.4.1.2	FOS	FoS will be fixed at 2.0 i.e., for every Rs.100 Cash withdrawn, there should be upto Rs. 200 cash available in the ATM. F	FOS is applicable only in case of ADD Cash ATMs . Need clarification	Terms & Conditions applicable as per RFP

310	3.4.1.7.	Factor of Safety (FoS)"	The Vendor shall not hold or retain in their vault more than 15% of the total cash taken from Bank	in cassette swap 100% Cash would be vaulted in CRA vault	Terms & Conditions applicable as per RFP
-----	----------	-------------------------	--	--	--

310	3.4.2	Cash Out	<p>In case the cash out extends beyond 3 hours and up to 10 hours, then penalty shall be Rs.2,500/- (for First three hours) + Rs. 2,500 for each hour or part thereof (excluding first three hours).</p>	<p>Very high penalty, it should be per day</p>	<p><b>CORRIGENDUM:</b></p> <p><del>a) Penalty shall be Rs. 2,500/- per incidence per endpoint for first 3 hours.</del></p> <p><del>b) In case the cash out extends beyond 3 hours and upto 10 hours, then penalty shall be Rs.2,500/- (for First three hours) + Rs. 2,500 for each hour or part thereof (excluding first three hours).</del></p> <p><del>c) if cash out continues beyond 10 hours, penalty shall be b) above (for first 10 hours) + Rs 5,000/- for each block of 4 hours or part thereof (excluding first 10 hours).</del></p> <p><del>Example: If a cash out incident is closed within 3 hours, the penalty shall be Rs. 2,500/- only. However, if it is closed in 30 hours, the penalty would be Rs. 45,000/- (Rs. 2500/- for first 03 hours + Rs.17500/- for next 07 hours (2500x7) + Rs. 25000/- (5000/- X 5 for next 20 hours)</del></p> <p>a) Cash-out at any ATM of more than five (05) hours in a month will attract a flat penalty of ₹ 5,000/- per ATM.</p> <p>b) Apart from above a), in case the cash out extends beyond five (05) hours and upto 10 hours in a month,</p>
-----	-------	----------	--	--	--

				<p>then penalty shall be Rs. 5,000/- (for First five hours) + ₹1,500/- for each hour (excluding first five hours in a month).</p> <p>c) if cash out continues beyond 10 hours in a month, penalty shall be for first 10 hours (as above, b)) + @ ₹500/- for each hour (excluding first 10 hours).</p> <p>Example: If Cash-out at any ATM of more than five (05) hours in a month, will attract a penalty of ₹ 5,000/- per ATM. However, if Cash-out at any ATM is 20 hours in a month, the penalty would be ₹17,500/- (Rs. 5000/- for first 05 hours + ₹7,500/- for next 05 hours (₹1,500 x 5) + ₹5000/- (₹500 X 10 for next 10 hours in a month).</p> <p>d) Bank shall levy penalty of Rs 2,500/- per incident, if reject bins not cleared within 4 hours.</p>
--	--	--	--	---



310	3.4.2	Cash Out	if cash out continues beyond 10 hours, penalty shall be b) above (for first 10 hours) + Rs 5,000/- for each block of 4 hours or part thereof (excluding first 10 hours).	Very high penalty, it should be per day	<p><b>CORRIGENDUM:</b></p> <p><del>a) Penalty shall be Rs. 2,500/- per incidence per endpoint for first 3 hours.</del></p> <p><del>b) In case the cash out extends beyond 3 hours and upto 10 hours, then penalty shall be Rs.2,500/- (for First three hours) + Rs. 2,500 for each hour or part thereof (excluding first three hours).</del></p> <p><del>c) if cash out continues beyond 10 hours, penalty shall be b) above (for first 10 hours) + Rs 5,000/- for each block of 4 hours or part thereof (excluding first 10 hours).</del></p> <p><del>Example: If a cash out incident is closed within 3 hours, the penalty shall be Rs. 2,500/- only. However, if it is closed in 30 hours, the penalty would be Rs. 45,000/- (Rs. 2500/- for first 03 hours + Rs.17500/- for next 07 hours (2500x7) + Rs. 25000/- (5000/- X 5 for next 20 hours)</del></p> <p>a) Cash-out at any ATM of more than five (05) hours in a month will attract a flat penalty of ₹ 5,000/- per ATM.</p> <p>b) Apart from above a), in case the cash out extends beyond five (05) hours and upto 10 hours in a month,</p>
-----	-------	----------	--	---	--

				<p>then penalty shall be Rs. 5,000/- (for First five hours) + ₹1,500/- for each hour (excluding first five hours in a month).</p> <p>c) if cash out continues beyond 10 hours in a month, penalty shall be for first 10 hours (as above, b)) + @ ₹500/- for each hour (excluding first 10 hours).</p> <p>Example: If Cash-out at any ATM of more than five (05) hours in a month, will attract a penalty of ₹ 5,000/- per ATM. However, if Cash-out at any ATM is 20 hours in a month, the penalty would be ₹17,500/- (Rs. 5000/- for first 05 hours + ₹7,500/- for next 05 hours (₹1,500 x 5) + ₹5000/- (₹500 X 10 for next 10 hours in a month).</p> <p>d) Bank shall levy penalty of Rs 2,500/- per incident, if reject bins not cleared within 4 hours.</p>
--	--	--	--	---

310	3.4.2	Cash out	a) Penalty shall be Rs. 2,500/- per incidence per endpoint for first 3 hours.	Hourly Cash out penalty is not acceptable, Ok with Rs 1000 Per instance	<p><b>CORRIGENDUM:</b></p> <p><del>a) Penalty shall be Rs. 2,500/- per incidence per endpoint for first 3 hours.</del></p> <p><del>b) In case the cash out extends beyond 3 hours and upto 10 hours, then penalty shall be Rs.2,500/- (for First three hours) + Rs. 2,500 for each hour or part thereof (excluding first three hours).</del></p> <p><del>c) if cash out continues beyond 10 hours, penalty shall be b) above (for first 10 hours) + Rs 5,000/- for each block of 4 hours or part thereof (excluding first 10 hours).</del></p> <p><del>Example: If a cash out incident is closed within 3 hours, the penalty shall be Rs. 2,500/- only. However, if it is closed in 30 hours, the penalty would be Rs. 45,000/- (Rs. 2500/- for first 03 hours + Rs.17500/- for next 07 hours (2500x7) + Rs. 25000/- (5000/- X 5 for next 20 hours)</del></p> <p>a) Cash-out at any ATM of more than five (05) hours in a month will attract a flat penalty of ₹ 5,000/- per ATM.</p> <p>b) Apart from above a), in case the cash out extends beyond five (05) hours and upto 10 hours in a month,</p>
-----	-------	----------	---	---	--

				<p>then penalty shall be Rs. 5,000/- (for First five hours) + ₹1,500/- for each hour (excluding first five hours in a month).</p> <p>c) if cash out continues beyond 10 hours in a month, penalty shall be for first 10 hours (as above, b)) + @ ₹500/- for each hour (excluding first 10 hours).</p> <p>Example: If Cash-out at any ATM of more than five (05) hours in a month, will attract a penalty of ₹ 5,000/- per ATM. However, if Cash-out at any ATM is 20 hours in a month, the penalty would be ₹17,500/- (Rs. 5000/- for first 05 hours + ₹7,500/- for next 05 hours (₹1,500 x 5) + ₹5000/- (₹500 X 10 for next 10 hours in a month).</p> <p>d) Bank shall levy penalty of Rs 2,500/- per incident, if reject bins not cleared within 4 hours.</p>
--	--	--	--	---

310	3.4.2	Cash out	<p>b) In case the cash out extends beyond 3 hours and up to 10 hours, then penalty shall be Rs.2,500/- (for First three hours) + Rs. 2,500 for each hour or part thereof (excluding first three hours).</p>	<p>Hourly Cash out penalty is not acceptable, Ok with Rs 1000 Per instance</p>	<p><b>CORRIGENDUM:</b></p> <p><del>a) Penalty shall be Rs. 2,500/- per incidence per endpoint for first 3 hours.</del></p> <p><del>b) In case the cash out extends beyond 3 hours and upto 10 hours, then penalty shall be Rs.2,500/- (for First three hours) + Rs. 2,500 for each hour or part thereof (excluding first three hours).</del></p> <p><del>c) if cash out continues beyond 10 hours, penalty shall be b) above (for first 10 hours) + Rs 5,000/- for each block of 4 hours or part thereof (excluding first 10 hours).</del></p> <p><del>Example: If a cash out incident is closed within 3 hours, the penalty shall be Rs. 2,500/- only. However, if it is closed in 30 hours, the penalty would be Rs. 45,000/- (Rs. 2500/- for first 03 hours + Rs.17500/- for next 07 hours (2500x7) + Rs. 25000/- (5000/- X 5 for next 20 hours)</del></p> <p>a) Cash-out at any ATM of more than five (05) hours in a month will attract a flat penalty of ₹ 5,000/- per ATM.</p> <p>b) Apart from above a), in case the cash out extends beyond five (05) hours and upto 10 hours in a month,</p>
-----	-------	----------	---	--	--

				<p>then penalty shall be Rs. 5,000/- (for First five hours) + ₹1,500/- for each hour (excluding first five hours in a month).</p> <p>c) if cash out continues beyond 10 hours in a month, penalty shall be for first 10 hours (as above, b)) + @ ₹500/- for each hour (excluding first 10 hours).</p> <p>Example: If Cash-out at any ATM of more than five (05) hours in a month, will attract a penalty of ₹ 5,000/- per ATM. However, if Cash-out at any ATM is 20 hours in a month, the penalty would be ₹17,500/- (Rs. 5000/- for first 05 hours + ₹7,500/- for next 05 hours (₹1,500 x 5) + ₹5000/- (₹500 X 10 for next 10 hours in a month).</p> <p>d) Bank shall levy penalty of Rs 2,500/- per incident, if reject bins not cleared within 4 hours.</p>
--	--	--	--	---

310	3.4.2	Cash out	c) if cash out continues beyond 10 hours, penalty shall be b) above (for first 10 hours) + Rs 5,000/- for each block of 4 hours or part thereof (excluding first 10 hours).	Hourly Cash out penalty is not acceptable, Ok with Rs 1000 Per instance	<p><b>CORRIGENDUM:</b></p> <p><del>a) Penalty shall be Rs. 2,500/- per incidence per endpoint for first 3 hours.</del></p> <p><del>b) In case the cash out extends beyond 3 hours and upto 10 hours, then penalty shall be Rs.2,500/- (for First three hours) + Rs. 2,500 for each hour or part thereof (excluding first three hours).</del></p> <p><del>c) if cash out continues beyond 10 hours, penalty shall be b) above (for first 10 hours) + Rs 5,000/- for each block of 4 hours or part thereof (excluding first 10 hours).</del></p> <p><del>Example: If a cash out incident is closed within 3 hours, the penalty shall be Rs. 2,500/- only. However, if it is closed in 30 hours, the penalty would be Rs. 45,000/- (Rs. 2500/- for first 03 hours + Rs.17500/- for next 07 hours (2500x7) + Rs. 25000/- (5000/- X 5 for next 20 hours)</del></p> <p>a) Cash-out at any ATM of more than five (05) hours in a month will attract a flat penalty of ₹ 5,000/- per ATM.</p> <p>b) Apart from above a), in case the cash out extends beyond five (05) hours and upto 10 hours in a month,</p>
-----	-------	----------	---	---	--

				<p>then penalty shall be Rs. 5,000/- (for First five hours) + ₹1,500/- for each hour (excluding first five hours in a month).</p> <p>c) if cash out continues beyond 10 hours in a month, penalty shall be for first 10 hours (as above, b)) + @ ₹500/- for each hour (excluding first 10 hours).</p> <p>Example: If Cash-out at any ATM of more than five (05) hours in a month, will attract a penalty of ₹ 5,000/- per ATM. However, if Cash-out at any ATM is 20 hours in a month, the penalty would be ₹17,500/- (Rs. 5000/- for first 05 hours + ₹7,500/- for next 05 hours (₹1,500 x 5) + ₹5000/- (₹500 X 10 for next 10 hours in a month).</p> <p>d) Bank shall levy penalty of Rs 2,500/- per incident, if reject bins not cleared within 4 hours.</p>
--	--	--	--	---



310	3.4.2	Cash Out:	For Cash Out, penalty shall be charged as under: -	Bank has imposed very high penalty only RBI related penalty should be imposed after considering all exclusion , over all penalty should be capped with in 5%	<p><b>CORRIGENDUM:</b></p> <p><del>a) Penalty shall be Rs. 2,500/- per incidence per endpoint for first 3 hours.</del></p> <p><del>b) In case the cash out extends beyond 3 hours and upto 10 hours, then penalty shall be Rs.2,500/- (for First three hours) + Rs. 2,500 for each hour or part thereof (excluding first three hours).</del></p> <p><del>c) if cash out continues beyond 10 hours, penalty shall be b) above (for first 10 hours) + Rs 5,000/- for each block of 4 hours or part thereof (excluding first 10 hours).</del></p> <p><del>Example: If a cash out incident is closed within 3 hours, the penalty shall be Rs. 2,500/- only. However, if it is closed in 30 hours, the penalty would be Rs. 45,000/- (Rs. 2500/- for first 03 hours + Rs.17500/- for next 07 hours (2500x7) + Rs. 25000/- (5000/- X 5 for next 20 hours)</del></p> <p>a) Cash-out at any ATM of more than five (05) hours in a month will attract a flat penalty of ₹ 5,000/- per ATM.</p> <p>b) Apart from above a), in case the cash out extends beyond five (05) hours and upto 10 hours in a month,</p>
-----	-------	-----------	--	--	--

				<p>then penalty shall be Rs. 5,000/- (for First five hours) + ₹1,500/- for each hour (excluding first five hours in a month).</p> <p>c) if cash out continues beyond 10 hours in a month, penalty shall be for first 10 hours (as above, b)) + @ ₹500/- for each hour (excluding first 10 hours).</p> <p>Example: If Cash-out at any ATM of more than five (05) hours in a month, will attract a penalty of ₹ 5,000/- per ATM. However, if Cash-out at any ATM is 20 hours in a month, the penalty would be ₹17,500/- (Rs. 5000/- for first 05 hours + ₹7,500/- for next 05 hours (₹1,500 x 5) + ₹5000/- (₹500 X 10 for next 10 hours in a month).</p> <p>d) Bank shall levy penalty of Rs 2,500/- per incident, if reject bins not cleared within 4 hours.</p>
--	--	--	--	---

310	3.4.2.	Cash Out:	Penalty shall be Rs. 2,500/- per incidence per endpoint for first 3 hours.	Very high penalty, it should be per day	<p><b>CORRIGENDUM:</b></p> <p><del>a) Penalty shall be Rs. 2,500/- per incidence per endpoint for first 3 hours.</del></p> <p><del>b) In case the cash out extends beyond 3 hours and upto 10 hours, then penalty shall be Rs.2,500/- (for First three hours) + Rs. 2,500 for each hour or part thereof (excluding first three hours).</del></p> <p><del>c) if cash out continues beyond 10 hours, penalty shall be b) above (for first 10 hours) + Rs 5,000/- for each block of 4 hours or part thereof (excluding first 10 hours).</del></p> <p><del>Example: If a cash out incident is closed within 3 hours, the penalty shall be Rs. 2,500/- only. However, if it is closed in 30 hours, the penalty would be Rs. 45,000/- (Rs. 2500/- for first 03 hours + Rs.17500/- for next 07 hours (2500x7) + Rs. 25000/- (5000/- X 5 for next 20 hours)</del></p> <p>a) Cash-out at any ATM of more than five (05) hours in a month will attract a flat penalty of ₹ 5,000/- per ATM.</p> <p>b) Apart from above a), in case the cash out extends beyond five (05) hours and upto 10 hours in a month,</p>
-----	--------	-----------	--	---	--

				<p>then penalty shall be Rs. 5,000/- (for First five hours) + ₹1,500/- for each hour (excluding first five hours in a month).</p> <p>c) if cash out continues beyond 10 hours in a month, penalty shall be for first 10 hours (as above, b)) + @ ₹500/- for each hour (excluding first 10 hours).</p> <p>Example: If Cash-out at any ATM of more than five (05) hours in a month, will attract a penalty of ₹ 5,000/- per ATM. However, if Cash-out at any ATM is 20 hours in a month, the penalty would be ₹17,500/- (Rs. 5000/- for first 05 hours + ₹7,500/- for next 05 hours (₹1,500 x 5) + ₹5000/- (₹500 X 10 for next 10 hours in a month).</p> <p>d) Bank shall levy penalty of Rs 2,500/- per incident, if reject bins not cleared within 4 hours.</p>
--	--	--	--	---

310

3.4.2.

Cash Out:

3.4.2.1. For Cash Out, penalty shall be charged as under: -  
a) Penalty shall be Rs. 2,500/- per incidence per endpoint for first 3 hours.  
b) In case the cash out extends beyond 3 hours and upto 10 hours, then penalty shall be Rs.2,500/- (for First three hours) + Rs. 2,500 for each hour or part thereof (excluding first three hours).  
c) if cash out continues beyond 10 hours, penalty shall be b) above (for first 10 hours) + Rs 5,000/- for each block of 4 hours or part thereof (excluding first 10 hours).  
Example: If a cash out incident is closed within 3 hours, the penalty shall be Rs. 2,500/- only. However, if it is closed in 30 hours, the

Bidder is requesting Bank to consider only RBI penalties for Cash related  
> Penalty for cash out is very high, not viable for bidder.  
> The Bidder would request for relaxation in penalties related to ATM downtime, FOS & Cash out etc during the initial period of two months from the date of award of the Contract since it is transition phase  
> Request to give relaxation for cash...  
i. Non-availability of cash as per bidder's cash indent;  
ii. Non-availability of denominations as per bidder's cash indent;  
iii. Non-issuance of cash from the cash issuing branch of the bidder as per agreed time for each location;  
iv. Abnormal increase in cash withdrawals by cardholders, high dispensation from machine;  
v) Late cash issuancy by bank, i.e. after 11 AM.  
vi) There should be relaxation for uncontrollable factors,

**CORRIGENDUM:**  
~~a) Penalty shall be Rs. 2,500/- per incidence per endpoint for first 3 hours.~~  
~~b) In case the cash out extends beyond 3 hours and upto 10 hours, then penalty shall be Rs.2,500/- (for First three hours) + Rs. 2,500 for each hour or part thereof (excluding first three hours).~~  
~~c) if cash out continues beyond 10 hours, penalty shall be b) above (for first 10 hours) + Rs 5,000/- for each block of 4 hours or part thereof (excluding first 10 hours).~~  
~~Example: If a cash out incident is closed within 3 hours, the penalty shall be Rs. 2,500/- only. However, if it is closed in 30 hours, the penalty would be Rs. 45,000/- (Rs. 2500/- for first 03 hours + Rs.17500/- for next 07 hours (2500x7) + Rs. 25000/- (5000/- X 5 for next 20 hours)~~  
a) Cash-out at any ATM of more than five (05) hours in a month will attract a flat penalty of ₹ 5,000/- per ATM.  
b) Apart from above a), in case the cash out extends beyond five (05) hours and upto 10 hours in a month,

				<p>natural disasters &amp; also there could be possibility of loading/EOD skip by bidder/CRA due to abnormal/uncontrollable situation like riots, force majeure, far offsites, transportations, area power failure, SLM bank dependency, access restriction, captive sites, ATM down at the time of loading etc.</p> <p>vii) Far offsite machine, where replenishment couldn't be possible daily, bidder can share such list.</p>	<p>then penalty shall be Rs. 5,000/- (for First five hours) + ₹1,500/- for each hour (excluding first five hours in a month).</p> <p>c) if cash out continues beyond 10 hours in a month, penalty shall be for first 10 hours (as above, b)) + @ ₹500/- for each hour (excluding first 10 hours).</p> <p>Example: If Cash-out at any ATM of more than five (05) hours in a month, will attract a penalty of ₹ 5,000/- per ATM. However, if Cash-out at any ATM is 20 hours in a month, the penalty would be ₹17,500/- (Rs. 5000/- for first 05 hours + ₹7,500/- for next 05 hours (₹1,500 x 5) + ₹5000/- (₹500 X 10 for next 10 hours in a month).</p> <p>d) Bank shall levy penalty of Rs 2,500/- per incident, if reject bins not cleared within 4 hours.</p>
--	--	--	--	---	---

310	3.4.2. Cash Out:		3.4.2.1. For Cash Out, penalty shall be charged as under: -	Cassette swap emergency replenishment/ reject bin clearance cannot be done on same day. Penalty is too high for each component over and above regulator penalty on cash out. Add cash also it will be depended on cash withdrawal from Branch / currency chest and there will be exceptional cases where replenishment / evacuation/EOD cannot be carried out i.e. ATM down, not accessible, vandalism case, power, theft, authority restriction ,CIT feasibility depending on location etc	<p><b>CORRIGENDUM:</b></p> <p><del>a) Penalty shall be Rs. 2,500/- per incidence per endpoint for first 3 hours.</del></p> <p><del>b) In case the cash out extends beyond 3 hours and upto 10 hours, then penalty shall be Rs.2,500/- (for First three hours) + Rs. 2,500 for each hour or part thereof (excluding first three hours).</del></p> <p><del>c) if cash out continues beyond 10 hours, penalty shall be b) above (for first 10 hours) + Rs 5,000/- for each block of 4 hours or part thereof (excluding first 10 hours).</del></p> <p><del>Example: If a cash out incident is closed within 3 hours, the penalty shall be Rs. 2,500/- only. However, if it is closed in 30 hours, the penalty would be Rs. 45,000/- (Rs. 2500/- for first 03 hours + Rs.17500/- for next 07 hours (2500x7) + Rs. 25000/- (5000/- X 5 for next 20 hours)</del></p> <p>a) Cash-out at any ATM of more than five (05) hours in a month will attract a flat penalty of ₹ 5,000/- per ATM.</p> <p>b) Apart from above a), in case the cash out extends beyond five (05) hours and upto 10 hours in a month,</p>
-----	------------------	--	---	---	--

				<p>then penalty shall be Rs. 5,000/- (for First five hours) + ₹1,500/- for each hour (excluding first five hours in a month).</p> <p>c) if cash out continues beyond 10 hours in a month, penalty shall be for first 10 hours (as above, b)) + @ ₹500/- for each hour (excluding first 10 hours).</p> <p>Example: If Cash-out at any ATM of more than five (05) hours in a month, will attract a penalty of ₹ 5,000/- per ATM. However, if Cash-out at any ATM is 20 hours in a month, the penalty would be ₹17,500/- (Rs. 5000/- for first 05 hours + ₹7,500/- for next 05 hours (₹1,500 x 5) + ₹5000/- (₹500 X 10 for next 10 hours in a month).</p> <p>d) Bank shall levy penalty of Rs 2,500/- per incident, if reject bins not cleared within 4 hours.</p>
--	--	--	--	---



310	3.4.2.1	Cash out Penalty	This is very exorbitant.	Request Bank to fix the Penalty not beyond 5% of the Monthly Cash loading charges for the said site.	<p><b>CORRIGENDUM:</b></p> <p><del>a) Penalty shall be Rs. 2,500/- per incidence per endpoint for first 3 hours.</del></p> <p><del>b) In case the cash out extends beyond 3 hours and upto 10 hours, then penalty shall be Rs.2,500/- (for First three hours) + Rs. 2,500 for each hour or part thereof (excluding first three hours).</del></p> <p><del>c) if cash out continues beyond 10 hours, penalty shall be b) above (for first 10 hours) + Rs 5,000/- for each block of 4 hours or part thereof (excluding first 10 hours).</del></p> <p><del>Example: If a cash out incident is closed within 3 hours, the penalty shall be Rs. 2,500/- only. However, if it is closed in 30 hours, the penalty would be Rs. 45,000/- (Rs. 2500/- for first 03 hours + Rs.17500/- for next 07 hours (2500x7) + Rs. 25000/- (5000/- X 5 for next 20 hours)</del></p> <p>a) Cash-out at any ATM of more than five (05) hours in a month will attract a flat penalty of ₹ 5,000/- per ATM.</p> <p>b) Apart from above a), in case the cash out extends beyond five (05) hours and upto 10 hours in a month,</p>
-----	---------	------------------	--------------------------	--	--

				<p>then penalty shall be Rs. 5,000/- (for First five hours) + ₹1,500/- for each hour (excluding first five hours in a month).</p> <p>c) if cash out continues beyond 10 hours in a month, penalty shall be for first 10 hours (as above, b)) + @ ₹500/- for each hour (excluding first 10 hours).</p> <p>Example: If Cash-out at any ATM of more than five (05) hours in a month, will attract a penalty of ₹ 5,000/- per ATM. However, if Cash-out at any ATM is 20 hours in a month, the penalty would be ₹17,500/- (Rs. 5000/- for first 05 hours + ₹7,500/- for next 05 hours (₹1,500 x 5) + ₹5000/- (₹500 X 10 for next 10 hours in a month).</p> <p>d) Bank shall levy penalty of Rs 2,500/- per incident, if reject bins not cleared within 4 hours.</p>
--	--	--	--	---

311	3.4.2	Cash Out	Bank shall levy penalty of Rs 2,500/- per incident, if reject bins not cleared within 4 hours	Very high penalty, it should be per day	Terms & Conditions applicable as per RFP
-----	-------	----------	---	---	--

311	3.4.3	Cash Reconciliation	<p>At the time of EOD (end of day) activity CRA will reconcile physical cash in the cassettes of endpoints and in the purge bin (reject bin) with the ADMIN balance (end cash shown denomination wise in ADMIN slip). Delay in EOD activity of endpoints results in reconciliation arrears. Therefore, for delay in reconciliation, vendor shall pay Rs.100/- per day per endpoint for the delayed period. However, Bank may at its discretion consider exceptional cases where EOD is not feasible daily due to genuine reason. Further any Loss occurred / penalty paid on account of delay in settling of dispute transactions on account of non-submission of EOD report will be</p>	<p>We request bank to remove the clause as in Cassette swapping CRA will not have access of cash</p>	<p><b>CORRIGENDUM:</b>  At the time of EOD (end of day) activity CRA will reconcile physical cash in the cassettes of endpoints and in the purge bin (reject bin) with the ADMIN balance (end cash shown denomination wise in ADMIN slip). Delay in EOD activity of endpoints results in reconciliation arrears. Therefore, for delay in reconciliation, vendor shall pay Rs.100/- per day per endpoint for the delayed period. <del>However, Bank may at its discretion consider exceptional cases where EOD is not feasible daily due to genuine reason.</del> Further any Loss occurred / penalty paid on account of delay in settling of dispute transactions on account of non-submission of EOD report will be recovered from Vendor.</p>
-----	-------	---------------------	--	--	---

		recovered from Vendor.		
--	--	------------------------	--	--

311	3.4.3	Cash Reconciliation	<p>The Vendor shall ensure that the entire cash handed over by the Bank is replenished in the ATMs by end of the day against which it had been provided. Reconciliation in this regard must be done on T+ 1 (where T is the replenishment day) basis in case of vaulting facility is extended to vendor and / or on T+0 in case no vaulting facility is extended to Vendor. In any case the cash must reconcile either by replenishment in ATMs or depositing in Branches on T+1 basis, failing which an interest @ clean overdraft rate prevalent at the material time will be recovered from the vendor along with the penalty of Rs. 5,000/- per instance.</p>	<p>Bank should exclude ATMs down due to NW, SLM and UPS reasons</p>	<p><b>CORRIGENDUM:</b> The Vendor shall ensure that the entire cash handed over by the Bank is replenished in the ATMs by end of the day against which it had been provided. Reconciliation in this regard must be done on T+ 1 (where T is the replenishment day) basis in case of vaulting facility is extended to vendor and / or on T+0 in case no vaulting facility is extended to Vendor. In any case the cash must reconcile either by replenishment in ATMs or depositing in Branches on T+1 basis, failing which an interest @ clean overdraft rate prevalent at the material time will be recovered from the vendor <del>along with the penalty of Rs. 5,000/-</del> per instance.</p>
-----	-------	---------------------	---	---	--

311	3.4.3. Cash Reconciliation:	3.4.3.2. The Vendor shall ensure that the entire cash handed over by the Bank is replenished in the ATMs by end of the day against which it had been provided. Reconciliation in this regard must be done on T+ 1 (where T is the replenishment day) basis in case of vaulting facility is extended to vendor and / or on T+0 in case no vaulting facility is extended to Vendor. In any case the cash must reconcile either by replenishment in ATMs or depositing in Branches on T+1 basis, failing which an interest @ clean overdraft rate prevalent at the material time will be recovered from the vendor along with the penalty of Rs. 5,000/- per instance.	This is not feasible in case of cassette swap, kindly reconsider.	<p><b>CORRIGENDUM:</b></p> <p>The Vendor shall ensure that the entire cash handed over by the Bank is replenished in the ATMs by end of the day against which it had been provided. Reconciliation in this regard must be done on T+ 1 (where T is the replenishment day) basis in case of vaulting facility is extended to vendor and / or on T+0 in case no vaulting facility is extended to Vendor. In any case the cash must reconcile either by replenishment in ATMs or depositing in Branches on T+1 basis, failing which an interest @ clean overdraft rate prevalent at the material time will be recovered from the vendor <del>along with the penalty of Rs. 5,000/-</del> per instance.</p>
-----	-----------------------------	---	---	---

311	3.4.3.1	Cash Reconciliation	<p>At the time of EOD (end of day) activity CRA will reconcile physical cash in the cassettes of endpoints and in the purge bin (reject bin) with the ADMIN balance (end cash shown denomination wise in ADMIN slip). Delay in EOD activity of endpoints results in reconciliation arrears. Therefore, for delay in reconciliation, vendor shall pay Rs.100/- per day per endpoint for the delayed period.</p>	<p>Penalty on EOD not done is not accepted.</p>	<p><b>CORRIGENDUM:</b>  At the time of EOD (end of day) activity CRA will reconcile physical cash in the cassettes of endpoints and in the purge bin (reject bin) with the ADMIN balance (end cash shown denomination wise in ADMIN slip). Delay in EOD activity of endpoints results in reconciliation arrears. Therefore, for delay in reconciliation, vendor shall pay Rs.100/- per day per endpoint for the delayed period. <del>However, Bank may at its discretion consider exceptional cases where EOD is not feasible daily due to genuine reason.</del> Further any Loss occurred / penalty paid on account of delay in settling of dispute transactions on account of non-submission of EOD report will be recovered from Vendor.</p>
-----	---------	---------------------	--	---	---



311	3.4.3.2	Cash Reconciliation	<p>3.4.3.2. The Vendor shall ensure that the entire cash handed over by the Bank is replenished in the ATMs by end of the day against which it had been provided. Reconciliation in this regard must be done on T+ 1 (where T is the replenishment day) basis in case of vaulting facility is extended to vendor and / or on T+0 in case no vaulting facility is extended to Vendor. In any case the cash must reconcile either by replenishment in ATMs or depositing in Branches on T+1 basis, failing which an interest @ clean overdraft rate prevalent at the material time will be recovered from the vendor along with the penalty of Rs. 5,000/- per instance.</p>	<p>Not Acceptable - We will ensure to close reference number in given time but penalty on reference number is not acceptable.</p>	<p><b>CORRIGENDUM:</b> The Vendor shall ensure that the entire cash handed over by the Bank is replenished in the ATMs by end of the day against which it had been provided. Reconciliation in this regard must be done on T+ 1 (where T is the replenishment day) basis in case of vaulting facility is extended to vendor and / or on T+0 in case no vaulting facility is extended to Vendor. In any case the cash must reconcile either by replenishment in ATMs or depositing in Branches on T+1 basis, failing which an interest @ clean overdraft rate prevalent at the material time will be recovered from the vendor <del>along with the penalty of Rs. 5,000/-</del> per instance.</p>
-----	---------	---------------------	--	---	--

311	3.4.3.2	Reconciliation	<p>The Vendor shall ensure that the entire cash handed over by the Bank is replenished in the ATMs by end of the day against which it had been provided. Reconciliation in this regard must be done on T+ 1 (where T is the replenishment day) basis in case of vaulting facility is extended to vendor and / or on T+0 in case no vaulting facility is extended to Vendor. In any case the cash must reconcile either by replenishment in ATMs or depositing in Branches on T+1 basis, failing which an interest @ clean overdraft rate prevalent at the material time will be recovered from the</p>	<p>We request bank to cap penalty of 100/-</p>	<p><b>CORRIGENDUM:</b> The Vendor shall ensure that the entire cash handed over by the Bank is replenished in the ATMs by end of the day against which it had been provided. Reconciliation in this regard must be done on T+ 1 (where T is the replenishment day) basis in case of vaulting facility is extended to vendor and / or on T+0 in case no vaulting facility is extended to Vendor. In any case the cash must reconcile either by replenishment in ATMs or depositing in Branches on T+1 basis, failing which an interest @ clean overdraft rate prevalent at the material time will be recovered from the vendor <del>along with the penalty of Rs. 5,000/-</del> per instance.</p>
-----	---------	----------------	--	--	--

		vendor along with the penalty of Rs. 5,000/- per instance.		
--	--	--	--	--

311	3.4.3.2.	Cash Reconciliation:	<p>The Vendor shall ensure that the entire cash handed over by the Bank is replenished in the ATMs by end of the day against which it had been provided. Reconciliation in this regard must be done on T+ 1 (where T is the replenishment day) basis in case of vaulting facility is extended to vendor and / or on T+0 in case no vaulting facility is extended to Vendor. In any case the cash must reconcile either by replenishment in ATMs or depositing in Branches on T+1 basis, failing which an interest @ clean overdraft rate prevalent at the material time will be recovered from the vendor along with the penalty of Rs. 5,000/- per instance.</p>	<p>&gt; Penalty is very high, not viable for bidder.          &gt; If indented machine is non-operational at the time of replenishment then would request to allow vaulting cash (if vault available).          &gt; If vault is unavailable then it will be loaded into some other machine.</p>	<p><b>CORRIGENDUM:</b>          The Vendor shall ensure that the entire cash handed over by the Bank is replenished in the ATMs by end of the day against which it had been provided. Reconciliation in this regard must be done on T+ 1 (where T is the replenishment day) basis in case of vaulting facility is extended to vendor and / or on T+0 in case no vaulting facility is extended to Vendor. In any case the cash must reconcile either by replenishment in ATMs or depositing in Branches on T+1 basis, failing which an interest @ clean overdraft rate prevalent at the material time will be recovered from the vendor <del>along with the penalty of Rs. 5,000/-</del> per instance.</p>
-----	----------	----------------------	---	--	---

311	3.4.3.3	Cash Reconciliation:	<p>In respect of recovery of losses, Penalties, Defrauded amount if any, shall be made good by vendor along with interest thereon at Banks' prevailing clean overdraft interest rate at material time and along with penalty at the rate of Rs.10,000 per Rs. 1,00,000/- (one lakh) or part thereof, by Vendor to BANK within 30 (thirty) days of occurrence of such fraud without waiting for admissibility or settlement of the insurance claim, if any. If the Vendor fails to make such payment with the said period of 30 days, then Bank reserves the right to recover the same by invoking the Bank guarantee submitted.</p>	<p>&gt; Penalty is very high, not viable for bidder.</p>	<p>Terms &amp; Conditions applicable as per RFP</p>
-----	---------	----------------------	---	--	---

311	3.4.3.3.	-	<p>In respect of recovery of losses, Penalties, Defrauded amount if any, shall be made good by vendor along with interest thereon at Banks' prevailing clean overdraft interest rate at material time and along with penalty at the rate of Rs.10,000 per Rs. 1,00,000/- (one lakh) or part thereof, by Vendor to BANK within 30 (thirty) days of occurrence of such fraud without waiting for admissibility or settlement of the insurance claim, if any. If the Vendor fails to make such payment with the said period of 30 days, then Bank reserves the right to recover the same by invoking the Bank guarantee submitted.</p>	<p>Requesting Bank to redraft this clause as it's dual lodd for MSP as interest and applied penalty.</p>	<p>Terms &amp; Conditions applicable as per RFP</p>
-----	----------	---	---	--	---

311	3.4.3.3.	3.4.3.3.	<p>In respect of recovery of losses, Penalties, Defrauded amount if any, shall be made good by vendor along with interest thereon at Banks' prevailing clean overdraft interest rate at material time and along with penalty at the rate of Rs.10,000 per Rs. 1,00,000/- (one lakh) or part thereof, by Vendor to BANK within 30 (thirty) days of occurrence of such fraud without waiting for admissibility or settlement of the insurance claim, if any. If the Vendor fails to make such payment with the said period of 30 days, then Bank reserves the right to recover the same by invoking the Bank guarantee submitted.</p>	<p>We request Bank to review the clause as penalties mentioned are very high.</p>	<p>Terms &amp; Conditions applicable as per RFP</p>
-----	----------	----------	---	---	---

311	3.4.3.3.	Penalty	<p>In respect of recovery of losses, Penalties, Defrauded amount if any, shall be made good by vendor along with interest thereon at Banks' prevailing clean overdraft interest rate at material time and along with penalty at the rate of Rs.10,000 per Rs. 1,00,000/- (one lakh) or part thereof, by Vendor to BANK within 30 (thirty) days of occurrence of such fraud without waiting for admissibility or settlement of the insurance claim, if any. If the Vendor fails to make such payment with the said period of 30 days, then Bank reserves the right to recover the same by invoking the Bank guarantee submitted</p>	<p>We request bank to remove the Penalty close as this penalty is not applicable</p>	<p>Terms &amp; Conditions applicable as per RFP</p>
-----	----------	---------	--	--	---



312	4	<b>PENALTY FOR NON-COMPLIANCE:</b>	Non-compliance to RBI / MHA guidelines on Cash Management Services in terms of RBI letter no. RBI / 2017-18 / 152 DCM (Plg) No. 3563 / 10.25.07 / 2017-18 April 06, 2018, will lead to penalty of Rs. 2,000 per day per Endpoint till the date it is complied with, and the compliance certificate is shared with the Bank. Bank may verify the said compliance on sample basi	We request bank to cap penalty of 100/-	Terms & Conditions applicable as per RFP
-----	---	------------------------------------	--	---	--

312	4	<p><b>PENALTY FOR NON-COMPLIANCE: (Non-compliance to the Statutory guidelines / any clause of RFP / SLA penalty)</b></p>	<p><b>4.2. Non-compliance to RBI / MHA guidelines on Cash Management Services in terms of RBI letter no. RBI / 2017-18 / 152 DCM (Plg) No. 3563 / 10.25.07 / 2017-18 April 06, 2018, will lead to penalty of Rs. 2,000 per day per Endpoint till the date it is complied with, and the compliance certificate is shared with the Bank. Bank may verify the said compliance on sample basis.</b></p>	<p><b>Bidder is requesting Bank to consider only RBI penalties for Cash related</b></p>	<p><b>Terms &amp; Conditions applicable as per RFP</b></p>
-----	---	--	---	---	--

312	4.2	PENALTY FOR NON-COMPLIANCE:	4.2. Non-compliance to RBI / MHA guidelines on Cash Management Services in terms of RBI letter no. RBI / 2017-18 / 152 DCM (Plg) No. 3563 / 10.25.07 / 2017-18 April 06, 2018, will lead to penalty of Rs. 2,000 per day per Endpoint till the date it is complied with, and the compliance certificate is shared with the Bank. Bank may verify the said compliance on sample basis.	Backup vehicle needs to be arrange if main vehicle break done to continue the services hence penalty on such cases needs to exempted. MHA followed currently only in SRO cities.	Terms & Conditions applicable as per RFP
312	4.3	PENALTY FOR NON-COMPLIANCE:	Cassette Swap- 5000 Penalty	We request bank to cap 100/- penalty	Terms & Conditions applicable as per RFP
312	3.4.4.	Counterfeit Currency:	y. A penalty of Rs 10,000/- per instance will be levied on the vendor whenever any Counterfeit Currency is detected by any manner from the following:	We request bank to remove the Penalty close as this penalty is not applicable	Terms & Conditions applicable as per RFP

312	3.4.4.1	Appendix-I PENALTIES & INCENTIVES	<p>The Vendor / CIT shall ensure correctness and genuineness of the cash and shall take only ATM fit currency notes for replenishment to its possession. Counting facility for currency notes shall be provided by the Bank. Once the note packets are received and acknowledged, Vendor would be responsible for shortage and fake currency if any, noticed subsequently. A penalty of Rs 10,000/- per instance will be levied on the vendor whenever any Counterfeit Currency is detected by any manner from the following:</p>	<p>The penalty here is too high, it shall be an amount equal to counterfeit currency and with a capping of Rs, 10,000/-. Request bank to relook on this clause.</p>	<p>Terms &amp; Conditions applicable as per RFP</p>
-----	---------	--------------------------------------	---	---	---

312	3.4.4.1	Counterfeit Currency:	<p>The Vendor / CIT shall ensure correctness and genuineness of the cash and shall take only ATM fit currency notes for replenishment to its possession. Counting facility for currency notes shall be provided by the Bank. Once the note packets are received and acknowledged, Vendor would be responsible for shortage and fake currency if any, noticed subsequently. A penalty of Rs 10,000/- per instance will be levied on the vendor whenever any Counterfeit Currency is detected</p>	<p>FSS will not responsible if any Fake note issue raised by customer after withdrawal of cash from ATMs. Secondly some branches don't have cash sorting machine. This is subject to cash sorting machine availability. We will replace note if found but no penalty acceptable.</p>	<p>Terms &amp; Conditions applicable as per RFP</p>
-----	---------	-----------------------	---	--	---

312	3.4.4.1	Counterfeit Currency:	<p>3.4.4.1.The Vendor / CIT shall ensure correctness and genuineness of the cash and shall take only ATM fit currency notes for replenishment to its possession. Counting facility for currency notes shall be provided by the Bank. Once the note packets are received and acknowledged, Vendor would be responsible for shortage and fake currency if any, noticed subsequently. A penalty of Rs 10,000/- per instance will be levied on the vendor whenever any Counterfeit Currency is detected by any manner from the following:</p>	<p>&gt; Request bank to provide sorted cash for replenishment.          &gt; Bidder would be able to trace fake currency without equipement &amp; also it is time consuming task, would lead to delay in ops.</p>	Terms & Conditions applicable as per RFP
-----	---------	-----------------------	---	---	--

312	4. PENALTY FOR NON-COMPLIANCE : (Non-compliance to the Statutory guidelines / any clause of RFP / SLA penalty)		4.2. Non-compliance to RBI / MHA guidelines on Cash Management Services in terms of RBI letter no. RBI / 2017-18 / 152 DCM (Plg) No. 3563 / 10.25.07 / 2017-18 April 06, 2018, will lead to penalty of Rs. 2,000 per day per Endpoint till the date it is complied with, and the compliance certificate is shared with the Bank. Bank may verify the said compliance on sample basis.	Penalty cannot be more than Billing in a month for defaulting in RBI/ MHA guidelines per ATM per month	Terms & Conditions applicable as per RFP
-----	--	--	---	--	--

312	<p><b>4. PENALTY FOR NON-COMPLIANCE : (Non-compliance to the Statutory guidelines / any clause of RFP / SLA penalty)</b></p>		<p><b>4.3. Non-compliance to RBI guidelines on the implementation of Cassette Swap Method in terms of RBI's letter No. RBI / 2017-18 / DCM (Plg.) No. 3641 / 10.25.007 / 2017-18 dated April 12, 2018, on Cassette Swap in ATMs and further refinement in this regard, if any. In case of non-compliance of specifications of lockable cassettes as per RBI letter a penalty as stipulated by RBI from time to time. The minimum penalty for non-compliance on account of cassette swap will be Rs. 5,000/- per day per ATMs.</b></p>	<p><b>Penalty cannot be more than Billing in a month for defaulting in RBI/ MHA guidelines per ATM per month</b></p>	<p><b>Terms &amp; Conditions applicable as per RFP</b></p>
-----	--	--	---	--	--



313	4.3	<b>PENALTY FOR NON-COMPLIANCE:</b>	<p>Non-compliance to RBI guidelines on the implementation of Cassette Swap Method in terms of RBI's letter No. RBI / 2017-18 / DCM (Plg.) No. 3641 / 10.25.007 / 2017-18 dated April 12, 2018, on Cassette Swap in ATMs and further refinement in this regard, if any. In case of non-compliance of specifications of lockable cassettes as per RBI letter a penalty as stipulated by RBI from time to time. The minimum penalty for non-compliance on account of cassette swap will be Rs. 5,000/- per day per ATMs.</p>	<p>Cassettes swap services implemented only at vault available locations as per IBA Categories cities subject to CRA infrastructure availability.</p> <p>Such huge penalty is not acceptable at all.</p>	<p>Terms &amp; Conditions applicable as per RFP</p>
-----	-----	------------------------------------	---	--	---

313	4.4	PENALTY FOR NON-COMPLIANCE:	The Vendors will ensure that their CIT / CRA will provide the uninterrupted services and in case of disruption of services on account of any reason Bank will recover the suitable cost from vendor in next bill up to the extent of Rs.5,000/- per endpoint per day for the period service was affected.	No Penalty Acceptable for this.	Terms & Conditions applicable as per RFP
-----	-----	-----------------------------	---	---------------------------------	--

313	4.5	PENALTY FOR NON-COMPLIANCE:	<p>Penalty @ Rs.5,000/- per Endpoint will be recovered from the Bidder if Clauses relating to RBI, MHA, IS Audit, Other compliances / guidelines and any clause mentioned in the scope of work of this RFP along with any appendix / corrigendum / addendum (of this RFP), is not adhered / not complied / failed during audit testing. The bidder should ensure to comply with the instructions within the timeframe allowed by the Bank. Failure to comply, penalty of Rs.2,000 per endpoint per day shall be levied beyond the timeframe allowed by the Bank.</p>	No Penalty Acceptable for this.	Terms & Conditions applicable as per RFP
-----	-----	-----------------------------	--	---------------------------------	--

313	5.1	SITE IMPLEMENTATION SERVICES:	<p>If the SIS is not completed within 30 days at metro areas and within 40 days at Rural / semi-Urban / Urban areas from the date of Purchase order placed by respective Circles, and the reason for delay is not attributable to the Bank, the vendor will be liable to pay a penalty of Rs. 5,000/- per machine per day from 31st day for metro and urban / 41st day for other areas, which will be realized / recovered from the vendor through their invoices. In case of any delay due to Bank dependency, the vendor has to advise the same in writing along with the necessary proof mentioning the cause of delay.</p>	Force Majeure conditions are not considered for relaxation in penalty due to delay	Terms & Conditions applicable as per RFP
-----	-----	-------------------------------	--	--	--

313	3.5.1	Deployment	Penalty of Rs 5000/- per day if ATM not deployed within 30 days for Metro and 40 days for Non Metro .	Request Bank to fix the Penalty not beyond 500 Rs per week.	Terms & Conditions applicable as per RFP
313	4. PENALTY FOR NON-COMPLIANCE : (Non-compliance to the Statutory guidelines / any clause of RFP / SLA penalty)		4.5. Penalty @ Rs.5,000/- per Endpoint will be recovered from the Bidder if Clauses relating to RBI, MHA, IS Audit, Other compliances / guidelines and any clause mentioned in the scope of work of this RFP along with any appendix / corrigendum / addendum (of this RFP), is not adhered / not complied / failed during audit testing. The bidder should ensure to comply with the instructions within the timeframe allowed by the Bank. Failure to comply, penalty of Rs.2,000 per endpoint per day shall be levied beyond the timeframe allowed by the Bank.	Penalty cannot be more than Billing in a month for defaulting in RBI/ MHA guidelines per ATM per month	Terms & Conditions applicable as per RFP

313	4.4 & 4.5	case of disruption of services	5000 Penalty	We request bank to remove the Penalty close as this penalty is not applicable	Terms & Conditions applicable as per RFP
313	4.4.	PENALTY FOR NON-COMPLIANCE	The Vendors will ensure that their CIT / CRA will provide the uninterrupted services and in case of disruption of services on account of any reason Bank will recover the suitable cost from vendor in next bill up to the extent of Rs.5,000/- per endpoint per day for the period service was affected.	This shall exclude IR issues	Terms & Conditions applicable as per RFP

313	5. SITE IMPLEMENTATION SERVICES	5.1	5.1. If the SIS is not completed within 30 days at metro areas and within 40 days at Rural / semi-Urban / Urban areas from the date of Purchase order placed by respective Circles, and the reason for delay is not attributable to the Bank, the vendor will be liable to pay a penalty of Rs. 5,000/- per machine per day from 31st day for metro and urban / 41st day for other areas, which will be realized / recovered from the vendor through their invoices.	The penalty should be one time per machine for delay on SIS.	Terms & Conditions applicable as per RFP
-----	---------------------------------	-----	--	--	--

314	5	<p><b>SITE IMPLEMENTATION SERVICES:</b></p>	<p>5.4. Replacement or repair of Lights, electrical components and any civil work repairs, printing &amp; implementation of creatives / posters advised by the Bank from time-to-time at new and existing sites will be done by the bidder throughout the Contract Period and extension thereof. There should not be fading or torn off posters / external signage / stickers / notice board / door and external glass see-through creatives etc. and their replacements to be done by the bidder immediately. Any repair / replacement / modification / implantation task under Site Maintenance Activities advised by the Bank should be completed by the bidder within 5 days</p>	<p>Bidder requesting Bank to revise the timelines &amp; penalties Suggesting below  Metro - 4 Days, U/S - 6 Days,  Rural - 8 Days, Penalty 100 Rs</p>	<p>Terms &amp; Conditions applicable as per RFP</p>
-----	---	---	--	---	---



		<p>of intimation. Penalty @ ₹ 500 per day from the 6th Day onwards per non-complied site will be levied.</p>		
--	--	--	--	--

314	5. SITE IMPLEMENTATION SERVICES:		5.7. On account of any negligence, commission or omission by the engineers of the Vendor in delivery of Product and Services if any penalty or loss or damage caused to bank, Vendor shall indemnify / pay / reimburse all such penalty / loss / damage suffered by Bank.	Kindly delete this clause since this is very open ended without specifying the details.	Terms & Conditions applicable as per RFP
315	5.8.	Penalty for EDSS:	5.8.1. Bidder shall attend and rectify the break down / repair / replacement of EDSS call(s) registered by Bank / Bank's representative within 2 days. Any repair / replacement / rectification / implantation task under EDSS advised by the Bank should be completed by the bidder within 2 days of intimation. Penalty @ ₹ 500 per day from the 3rd day onwards	Bidder requesting Bank to do not impose Penalty on EDSS front since this is new service from Bidder end	<b>CORRIGENDUM:</b> Bidder shall attend and rectify the break down / repair / replacement of EDSS call(s) registered by Bank / Bank's representative within <b>2 4</b> days. Any repair / replacement / rectification / implantation task under EDSS advised by the Bank should be completed by the bidder within <b>2 4</b> days of intimation. Penalty @ ₹ 500 per day from the <del>3rd</del> <b>5th</b> day onwards per non-complied call(s) will be levied.

			per non-complied call(s) will be levied.		
315	5.8.1	Penalty for EDSS	Bidder shall attend and rectify the break down / repair / replacement of EDSS call(s) registered by Bank / Bank's representative within 2 days. Any repair / replacement / rectification / implantation task under EDSS advised by the Bank should be completed by the bidder within 2 days of intimation. Penalty @ ₹ 500 per day from	2 days only for non-part. For parts it should be 3 days for Metro and 5 days for Rural	<b>CORRIGENDUM:</b> Bidder shall attend and rectify the break down / repair / replacement of EDSS call(s) registered by Bank / Bank's representative within <del>2</del> <b>4</b> days. Any repair / replacement / rectification / implantation task under EDSS advised by the Bank should be completed by the bidder within <del>2</del> <b>4</b> days of intimation. Penalty @ ₹ 500 per day from the <del>3rd</del> <b>5th</b> day onwards per non-complied call(s) will be levied.

			the 3rd day onwards per non-complied call(s) will be levied.		
315	5.8.2	Appendix-I PENALTIES & INCENTIVES	Bidder to ensure that no content without specific permission of the Bank shall display. No unsolicited / unwarranted content shall be displayed at any circumstances on EDSS. In case of non-compliance, penalty of Rs. 50,000 for each instance, alongwith any other penalty(ies) imposed on the Bank by any statutory body(ies), will be imposed and	The penalty here is too high, request bank to relook on this clause.	Terms & Conditions applicable as per RFP

			recovered from the bidder.		
315	5.8.3	Ess Penalty	5.8.3. e-Surveillance Systems (eSS) should be functional / operational 24x7x365. If any deficiency observed / found by Bank / Bank's representative, a penalty of Rs 2,000/= per instance per site shall be recovered from the Vendor.	Request Bank to fix the Penalty not beyond 200 Rs per week.	<b>CORRIGENDUM:</b> 5.8.3. e-Surveillance Systems (eSS) should be functional / operational 24x7x365. If any deficiency observed / found by Bank / Bank's representative, a penalty of <del>Rs 2,000/=</del> <b>₹1,000</b> per instance per site shall be recovered from the Vendor.

316	6	TESTING & MACHINE TECHNICAL ISSUES:	6.3. If OEM XFS application failed to provide dispensation status to Bank's MVS application and has resulted in customer complaint for which no excess cash is found in the endpoint, then Vendor is liable to bear the transaction amount and compensation to be paid to the customer along with any other loss / penalty imposed on Bank.	The Bidder requesting Bank to give exclusiton on this penalty incase of MVS Vendor issues	Terms & Conditions applicable as per RFP
-----	---	-------------------------------------	---	---	--

316	8. PENALTY FOR NON-SUBMISSION OF BANK GUARANTEE	8.1	8.1. Non-submission of Bank Guarantee related to Cash loss within 15 days from the issue of PO by Circles, a penalty of Rs.5,000/- per day per machine will be charged to the vendor from the 16th day onwards till the same is submitted. In the event of failure on the part of the vendor to pay for cash losses as per the terms and conditions, the Bank shall be entitled to invoke the guarantee.	Request Bank to consider only one Bank guarantee on overall project i.e. TCO or Cash Security.	Terms & Conditions applicable as per RFP
-----	---	-----	--	--	--

317	9	E-SURVEILLANCE:	<p>No. Parameter Metric Penalty</p> <p>1. Equipment Uptime At least 99% uptime expected.</p> <p>i. System is non-functional for more than 30 minutes up to 4 Hours, ii. system remains non-functional beyond 4 hrs and up to 24 hours, iii. system remains non-functional beyond 24Hrs. up to 48Hrs, iv. system remains non-functional beyond 48 Hrs,</p> <p>i. Rs 1,500/- ii. Rs 2,500/- iii. Rs 3,500/- iv. Rs 5,000/- for that site for each instance of failure beyond 48 hours.</p>	<p>Requesting Bank to change this clause, below are the suggestions</p> <p>More than 30 Minutes - 4 Hrs - 100 Rs 4-24 Hrs - 200 Rs 24-48 Hrs - 300 Rs &gt;48 Hrs - 500 Rs</p>	<p>Terms &amp; Conditions applicable as per RFP</p>
-----	---	-----------------	--	---	---



317	9	E-SURVEILLANCE:	<p>i. System is nonfunctional for more than 30 minutes up to 4 Hours,  ii. system remains nonfunctional beyond 4 hrs and up to 24 hours,  iii. system remains nonfunctional beyond 24Hrs. up to 48Hrs,  iv. system remains nonfunctional beyond 48 Hrs,  i. Rs 1,500/-  ii. Rs 2,500/-  iii. Rs 3,500/-  iv. Rs 5,000/- for that site for each instance o</p>	Bidder request no penalty on such instance and no penalty untill there is loss to Bank	Terms & Conditions applicable as per RFP
-----	---	-----------------	---	--	--

317	9. E-SURVEILLANCE:	9.1	<p>At least 99% uptime expected.</p> <p>i. System is non-functional for more than 30 minutes up to 4 Hours - i. Rs 1,500/-</p> <p>ii. system remains non-functional beyond 4 hrs and up to 24 hours - ii. Rs 2,500/-</p> <p>iii. system remains non-functional beyond 24Hrs. up to 48Hrs - iii. Rs 3,500/-</p> <p>iv. system remains non-functional beyond 48 Hrs - Rs 5,000/- for that site for each instance of failure beyond 48 hours.</p>	<p>At least 99% uptime expected.</p> <p>i. System is non-functional for more than 30 minutes up to 4 Hours - i. Rs 300/-</p> <p>ii. system remains non-functional beyond 4 hrs and up to 24 hours - ii. Rs 400/-</p> <p>iii. system remains non-functional beyond 24Hrs. up to 48Hrs - iii. Rs 500/-</p> <p>iv. system remains non-functional beyond 48 Hrs - Rs 750/- for that site for each instance of failure beyond 48 hours.</p>	Terms & Conditions applicable as per RFP
317	9. E-SURVEILLANCE:	9.2	<p>A penalty of Rs. 1,000/- per week from the next day of cash live, till the date of making e-Surveillance live. The penalty amount for delayed installations will be due on 1st day of the week. This will be over and above the</p>	<p>The Penalty should be under the suggested monthly capping on monthly bills payment</p>	Terms & Conditions applicable as per RFP

			monthly cap of 35% on bills payment.		
317	9. E-SURVEILLANCE:	E-SURVEILLANCE:	2. Non installation of E-Surveillance From the date of Cash Live A penalty of Rs. 1,000/- per week from the next day of cash live, till the date of making e-Surveillance live. The penalty amount for delayed installations will be due on 1st day of the week. This will be over and above the monthly cap of 35% on bills payment.	The Bidder requests the bank to keep the penalty capped at not more than 5% of the bill amount	Terms & Conditions applicable as per RFP
317	9. E-SURVEILLANCE:		9. E-SURVEILLANCE:	Penalty for all component is too high	Terms & Conditions applicable as per RFP

317		eSurveillance		Request Bank to fix the penalty not beyond 200 per Site per month.	Terms & Conditions applicable as per RFP
318	9	E-SURVEILLANCE:	<p>6. 1.2.13.1 NonSupply of Video Footage</p> <p>1.2.13.2 Nonretention of footage as per the request received from the Bank</p> <p>For not providing CCTV footage for any incident / ENDPOINT transactionbased footage. For not providing clear images and video (face not recognizable)</p> <p>Rs. 10,000 OR Actual loss to the bank, whichever is higher.</p>	Bidder request waiver of this penalty as not viable	Terms & Conditions applicable as per RFP

318	9	E-SURVEILLANCE:	8 Failure of any equipment / sensor should be replaced / repaired within 24 hours. Beyond 24 hours, penalty will be as under: Rs 5000/- for that site for each instance of failure up to 72 hours. Rs 10,000/- for that site for	Bidder request to reduce the penalty as not viable	Terms & Conditions applicable as per RFP
318	9	E-SURVEILLANCE:	1.2.13.1 Non-Supply of Video Footage 1.2.13.2 Non-retention of footage as per the request received from the Bank	Penalty shouldn't be more than the Monthly Revenue	Terms & Conditions applicable as per RFP
318	9	E-SURVEILLANCE:	8 Failure of any equipment / sensor should be replaced / repaired within 24 hours	Penalty shouldn't be more than the Monthly Revenue	Terms & Conditions applicable as per RFP
318	9. E-SURVEILLANCE:	E-SURVEILLANCE:	6. 1.2.13.1 Non-Supply of Video Footage 1.2.13.2 Non-retention of footage as per the request	The Bidder request the Bank to reduce this penalty to Rs 1000	Terms & Conditions applicable as per RFP

			received from the Bank		
318	9. E-SURVEILLANCE:	E-SURVEILLANCE:	8 Failure of any equipment / sensor should be replaced / repaired within 24 hours.	Bidder is requesting Bank to reduce the same as following 100 per instance upto 72 Hrs 500 per instance beyond 72 Hrs	Terms & Conditions applicable as per RFP
319	9	E-SURVEILLANCE:	11. Non-installation of dismantled site If bank/bidder shifts the ATM to new location or discontinues the site, the reinstallation at new location next day of making the machine cash live A penalty of Rs. 1,000/- per week from the next day of cash live, till the date of making e-Surveillance live.	Standard TAT for reinstallation in 14 days from the date of notification. & feasibility on new site also to be considered for TAT	Terms & Conditions applicable as per RFP

			The penalty amount for delayed installations will be due on 1st day of the week.		
319	9	E-SURVEILLANCE:	12. Non-maintenance of TAT for providing CCTV footages For not providing images / footages within 1 day of receipt of such requests from the Bank. Rs. 500/- per day for such delays beyond 1 day	TAT for footage in 4 working days , as requested above. Can not be 1 day of TAT	Terms & Conditions applicable as per RFP
319	9	E-SURVEILLANCE:	11 Non-installation of dismantled site	Penalty shouldn't be more than the Monthly Revenue	Terms & Conditions applicable as per RFP

319	9	E-SURVEILLANCE:	12 Non-maintenance of TAT for providing CCTV footages	Penalty shouldn't be more than the Monthly Revenue	Terms & Conditions applicable as per RFP
319	12	Non-maintenance of TAT for providing CCTV footages	For not providing images / footages within 1 day of receipt of such requests from the Bank.	For footage of longer duration where engineer visit is required require at least 5 working days TAT	Terms & Conditions applicable as per RFP
319	9. E-SURVEILLANCE:	E-SURVEILLANCE:	11. Non-installation of dismantled site If bank/bidder shifts the ATM to new location or discontinues the site, the reinstallation at new location next day of making the machine cash live A penalty of Rs. 1,000/- per week from the next day of cash live, till the date of making e-Surveillance live. The penalty amount for delayed installations will be due on 1st day of the week.	The Bidder requested Bank to provide the relaxation on this clause, Alleast Bank to share the 7 Days time	Terms & Conditions applicable as per RFP



319	9. E-SURVEILLANCE:	E-SURVEILLANCE:	12. Non-maintenance of TAT for providing CCTV footages For not providing images / footages within 1 day of receipt of such requests from the Bank. Rs. 500/- per day for such delays beyond 1 day.	The Bidder requested Bank to provide the relaxation on this clause, Atleast Bank to share the 3 Days time	Terms & Conditions applicable as per RFP
320	9	E-SURVEILLANCE:	13 Non-Submission of e-surveillance system down report	Penalty shouldn't be more than the Monthly Revenue	Terms & Conditions applicable as per RFP
320	10	EJ Penalties:	a) EJ disabled and EJ disconnected cases not resolved within T+1 days.	The Bidder requested Bank to provide the relaxation on this clause, Atleast Bank to share the 3 Days time	Terms & Conditions applicable as per RFP

320	10 c)	EJ Penalties	<p>It is desirable that necessary agreements are in place between the respective vendor stakeholders (between TOM vendor, Hardware OEM, Software vendor, Network SP) for field operational issues and necessary SOP may be prepared by the TOM vendor in documenting the roles and responsibilities of the respective stakeholders to avoid any dispute amongst vendor stakeholders in providing services to the Bank.</p>	<p>Since MVS would be done from Day-1, EJ will be pulled by the Bank's MVS vendor. We request Bank to instruct MVS vendor to provide reporting views and access as required by MSP to ensure effectiveness of EJ pulling</p>	<p>Terms &amp; Conditions applicable as per RFP</p>
-----	-------	--------------	--	--	---

321	10 d)	EJ Penalties	Bank shall not be a party in such disputes, and it will be the responsibility of the successful bidder / Service provider (i.e., TOM vendors) for resolution of any transaction / EJ dispute and accountable for penalty if any in any event of non-availability or incomplete EJ / required logs due to MVS / Network / Hardware or any other issue	MVS is Bank's vendor and MVS vendor does not co-operate unless Bank's approvals on several aspects.  We request bank to exclude this clause of EJ penalties when attributed to MVS or not imposed until resolution of dispute	Terms & Conditions applicable as per RFP
325	2.1.7	Definition: TOM	Any future guidelines / advisory by any statutory authority shall be complied without any cost to the Bank	Request Bank to modify this clause and keep it at mutually agreed price as The Bidder is not a banking entity and neither does it have any visibility on the future guidelines / advisory by any statutory authority and hence, in the interest of success of the project, it is fair and reasonable that both parties mutually agree on the compliance of the guidelines / advisory and the Bank should support the Bidder from Commercial perspective.	<b>CORRIGENDUM:</b> Any <b>new</b> future guidelines /advisory by any statutory / <b>regulatory</b> authority shall be complied <del>without any cost to the Bank</del> <b>with mutually agreed terms &amp; conditions and within the timeline advised by the authority.</b>

326	2.1.12	“ATM ( / A TM Machine / Cash Dis penser (CD) Equipment / Pr od uct / Endpoint / End po i nts / T e rmi nal / M achine	means – all the hardware, it’s all components, peripheral apparatus, associated software/ firmware/ operating software, Software Agent(s)	Bidders responsibility should be limited to the deliverables specified by the Bank under the respective Appendixes. Any changes / modifications / additions needed by the Bank beyond the agreed specification should be mutually agreed between the Parties.	Terms & Conditions applicable as per RFP
326	2.1.13	Definition: Services	means all hardware and software products, services, scope of work under Appendix-E and deliverables to be provided by a Vendor as described in the RFP and include services ancillary to the development of the solution, such as installation, commissioning, integration with existing systems, provision of technical assistance, training, certifications, auditing and all other obligations of Service Provider covered under this RFP.	<p>1. Certifications is a broad terminology. The Bank should clearly specify the certifications to be taken by the Bidder to ascertain the cost. If the Bank is not able to provide the details of Certifications then it should be deleted.</p> <p>2. Bank to explain how Auditing is service provided by the Bidder.</p>	Terms & Conditions applicable as per RFP

328	2.1.29	<p>MVS: Multi-Vendor Software (MVS) - A standardized secure software solution and platform to run, manage and improve the functionality of the ATM network while providing additional functions like online monitoring of the ATMs.</p>	<p>MVS: Multi-Vendor Software (MVS) - A standardized secure software solution and platform to run, manage and improve the functionality of the ATM network while providing additional functions like online monitoring of the ATMs.</p>	<p>Please confirm the mechanism used for ATM remote monitoring. Is it SNMP based monitoring / ICMP based monitoring ? Please confirm the Frequency of keepalive and packet size .</p>	<p>Terms &amp; Conditions applicable as per RFP  Clarification: Online monitoring of the ATMs is done through Agent-Based monitoring which is based on XFS/Event error codes generated by the terminal.  For keep-alive checks of the terminal(in case of communication down scenarios), ICMP is used every minute.  Packet size may vary depending on the type of file/request(Min size: 84 Bytes to Max size: 10240 Bytes)</p>
-----	--------	---	---	---	--

328	2.1.29	Appendix–J DRAFT SERVICE LEVEL AGREEMENT DEFINITIONS & INTERPRETATION	MVS: Multi Vendor Software ( MVS) A standardized secure software solution and platform to run, manage and improve the functionality of the ATM network while providing additional functions like online monitoring of the ATMs	As per Network Service Provider 2 - Please confirm the mechanism used for ATM remote monitoring. Is it SNMP based monitoring / ICMP based monitoring ? Frequency of keepalive and packet size .	Terms & Conditions applicable as per RFP Clarification: Online monitoring of the ATMs is done through Agent-Based monitoring which is based on XFS/Event error codes generated by the terminal. For keep-alive checks of the terminal(in case of communication down scenarios), ICMP is used every minute. Packet size may vary depending on the type of file/request(Min size: 84 Bytes to Max size: 10240 Bytes)
328	2.1.29	MVS	MVS: Multi-Vendor Software (MVS) - A standardized secure software solution and platform to run, manage and improve the functionality of the ATM network while providing additional functions like online monitoring of the ATMs.	Please confirm the mechanism used for ATM remote monitoring. Is it SNMP based monitoring / ICMP based monitoring ? Frequency of keepalive and packet size .	Terms & Conditions applicable as per RFP Clarification: Online monitoring of the ATMs is done through Agent-Based monitoring which is based on XFS/Event error codes generated by the terminal. For keep-alive checks of the terminal(in case of communication down scenarios), ICMP is used every minute. Packet size may vary depending on the type of file/request(Min size: 84 Bytes to Max size: 10240 Bytes)

328	2.1.29	MVS: Multi Vendor Software (MVS)	MVS: Multi-Vendor Software (MVS) - A standardized secure software solution and platform to run, manage and improve the functionality of the ATM network while providing additional functions like online monitoring of the ATMs.	Please confirm the mechanism used for ATM remote monitoring. Is it SNMP based monitoring / ICMP based monitoring ? Please confirm the Frequency of keepalive and packet size .	Terms & Conditions applicable as per RFP Clarification: Online monitoring of the ATMs is done through Agent-Based monitoring which is based on XFS/Event error codes generated by the terminal. For keep-alive checks of the terminal(in case of communication down scenarios), ICMP is used every minute. Packet size may vary depending on the type of file/request(Min size: 84 Bytes to Max size: 10240 Bytes)
328	2.1.29		MVS: Multi-Vendor Software (MVS) - A standardized secure software solution and platform to run, manage and improve the functionality of the ATM network while providing additional functions like online monitoring of the ATMs.	Please confirm the mechanism used for ATM remote monitoring. Is it SNMP based monitoring / ICMP based monitoring ? Please confirm the Frequency of keepalive and packet size .	Terms & Conditions applicable as per RFP Clarification: Online monitoring of the ATMs is done through Agent-Based monitoring which is based on XFS/Event error codes generated by the terminal. For keep-alive checks of the terminal(in case of communication down scenarios), ICMP is used every minute. Packet size may vary depending on the type of file/request(Min size: 84 Bytes to Max size: 10240 Bytes)

329	2.1.39	Definition: Documentation	<p>means documentation that legally binding on all parties to it discharges, varies or supplementals the legal obligations contained in the agreement / SLA/ RFP/letter and will describe in detail and in a completely self-contained manner how the User may access and use the installation of ATMs under Total Outsourced Model (name of the Software/ Hardware/ Maintenance Services) &lt;Strike off whichever is inapplicable&gt;, such that any reader of the Documentation can access, use and maintain all of the functionalities of the ..... (Name of Software) ..... (Service), without the need for any further instructions.</p>	<p>The definition of Documentation is very broad. The Product Documentation is very standard document offered to the customers in generally. The Bank to amend the definition to narrow its meaning to mean training, installation, published specifications, and operation manuals that Bidder makes generally available to its customers to assist in use of a Product</p>	<p>Terms &amp; Conditions applicable as per RFP</p>
-----	--------	---------------------------	--	--	---



**'Documentation'**  
includes, user  
manuals, installation  
manuals, operation  
manuals, design  
documents, process  
documents, technical  
manuals, functional  
specification,  
software requirement  
specification, on-line  
tutorials / CBTs,  
system configuration  
documents, system  
/ database  
administrative  
documents,  
debugging /  
diagnostics  
documents, test

procedures, Review  
Records/ Test Bug  
Reports/ Root Cause  
Analysis Report, list of  
all Product  
components, list of all  
dependent/external  
modules and list of all  
documents relating to  
traceability of the  
Product as and when  
applicable etc.

330	2.1.43	Definition: ATM Loss	ATM Loss” means loss of Valuables solely from a single ATM	The definition is very broad. Bank should provide adequate clarity to the Bidder that the ATM Loss under the RFP and Agreement means loss solely caused by the Service Provider or its employees.	Terms & Conditions applicable as per RFP
332	4.1	4. Fees/Compensation	4.1 The Compensation / payment terms is mentioned in the Annexure-C of SLA. 4.2 The Payment Terms for the work which Service Provider has to provide to the Bank (Services) is in terms of clauses given below:	What are the timelines for the Bank to provide the transaction report / switch report? The Bidder will not be able to bill the Bank until the Bank provides the transaction report. The Bank should provide access to its systems to the Bidder so that the Bidder can download the transaction report and bill the customer.	Terms & Conditions applicable as per RFP

332	2.3.1	2.3 COMMENCEMENT, TERM & CHANGE IN TERM:	<p>2.3.1 This Agreement shall commence from its date of execution mentioned above / be deemed to have commenced from (Effective Date).</p> <p>2.3.2 This Agreement shall be in force for a period of seven (07) year(s) from Effective Date</p>	<p>Request Bank to append the below in this clause:</p> <p>"The initial period of 24 months from the Effective Date shall be the deployment period during which the Service Provider will complete deployment of _____ ATM sites, provided that the Bank complies with its obligations. Bank may extend the initial deployment for 6 months if the completion of deployment is delayed for reasons not attributable solely to the Service Provider."</p> <p>2.3.2 This Agreement shall be in force for a period of seven (07) year(s) from completion of the initial deployment period.</p> <p>Justification: The Bank has not considered the deployment period needed to deploy the ATM sites allocated to the Bidder. The Bank should consider at least 24 months from the Effective Date for completing the deployment of the ATM sites. The term of the Agreement should start from</p>	Terms & Conditions applicable as per RFP
-----	-------	--	---	---	--

			the date of completion of the Deployment Period.	
--	--	--	---	--

332	2.3.4	2.3 COMMENCEMENT, TERM & CHANGE IN TERM:	2.3.4 . The Bank will also have the first right of refusal for the Site on termination / expiry of SLA.	The Bidder will bear the costs of identification, legal costs etc and maintaining the sites. Will the Bank compensate the Bidder for providing the first right of refusal for the site on termination or expiry of the SLA. The Bidder will stand to lose if the Bank decides to exercise its right of first refusal only for not so good sites but keeps good transacting sites. The Bank should be able to use the sites only during the term of the agreement and not beyond that.	Terms & Conditions applicable as per RFP
332	Appendix J	2.3. 1	2.3.2 This Agreement shall be in force for a period of seven (07) year(s) from Effective Date, unless terminated by the Bank by notice in writing in accordance with the termination clauses of this Agreement.	The termination of the Agreement shall be mutual and the bidder shall have the right to terminate the Agreement as well.	Terms & Conditions applicable as per RFP

332	Appendix J	2.3.2	2.3.3 The Bank shall have the right at its discretion to renew this Agreement in writing, for a further term upto another three (03) years in one or more tranches after 7 years and such extension (if any required by Bank) shall be binding on selected bidder(s).	The renewal of the Agreement shall be with mutual consent of the parties.	Terms & Conditions applicable as per RFP
333	Appendix J	4.3.4	4.3.4 The Bank may withhold payment of any product / services that it disputes in good faith and may set-off penalty amount or any other amount or adjustment of amount which Service Provider owes to the Bank against amount payable to Service provider under this Agreement.	We suggest that no set-off should be done as it would lead to revenue losses.	Terms & Conditions applicable as per RFP

334	Appendix J	4.3.5	4.3.5 Once Purchase Order or Letter of Intent is issued by the Bank, the said price will remain fixed for the entire Contract period & extension thereof and shall not be subjected to variation on any account, including exchange rate fluctuations, any upward revision in duties, charges, etc.	The Banks fee shall be subject to price change if there is a change in price due to change in any law/order etc. In such an event, the Bank shall agree to such change in price.	Terms & Conditions applicable as per RFP
-----	------------	-------	---	--	--

<p>335</p>	<p>Appendix–J DRAFT SERVICE LEVEL AGREEMENT</p>	<p>4.4 BANK GUARANTEE AND PENALTY:</p>	<p>4.4.6 The PBG is required to protect the interest of the Bank against delay in supply installation and or the risk of non performance or failure to perform any obligation(s) under this RFP / SLA either fully or partially, of the successful Bidder in respect of implementation of the project, or performance of the agreement(s) pursuant to this RFP / SLA or material or services sold, which may warrant invoking of PBG. In case any act of the supplier results in imposition of Liquidated Damages then also the Bank reserves the right to invoke the PBG.</p>	<p>Requested Changes : Bank to provide a cure period in the circumstances mentioned in the clause before levying penalty on the Bidder. Further under no circumstance shall bank levy the penalty without the consent of the Bidder.</p>	<p>Terms &amp; Conditions applicable as per RFP</p>
------------	---	--	--	--	---



335	Appendix–J DRAFT SERVICE LEVEL AGREEMENT	4.4 B ANK GUARANTEE AND PENALTY:	4.4.8 - ____ In the event of failure on the part of the vendor to pay for cash losses as per the terms and conditions, the Bank shall be entitled to invoke the guarantee.	Requested Changes : Bank to provide a cure period in the circumstances mentioned in the clause before levying penalty on the Bidder. Further under no circumstance shall bank levy the penalty without the consent of the Bidder.	Terms & Conditions applicable as per RFP
336	Appendix–J DRAFT SERVICE LEVEL AGREEMENT	4.4 B ANK GUARANTEE AND PENALTY:	4.4.12 Any delay in performing the obligation / defect in performance by Service Provider may result in imposition of penalty , liquidated damages, invocation of PBG / Bank Guarantee and or termination of Contract (as laid down elsewhere in this RFP / SLA document)	Requested Changes : The Bidder is liable for any claim, demand, losses, liabilities or expenses of any nature and kind whatsoever which are directly attributable to it and not otherwise.	Terms & Conditions applicable as per RFP
336	4.4.6	4.4 BANK GUARANTEE AND PENALTY:	In case any act of the supplier results in imposition of Liquidated Damages and the Bidder fails to pay the liquidated damages then also the Bank reserves the right to invoke the PBG.	The Bank should provide reasonable time of 30 days to the Bidder to pay the liquidated damages before invoking the BG.	Terms & Conditions applicable as per RFP

337	4.4.12	PAYMENTS TERMS AND CONDITIONS	Any delay in performing the obligation / defect in performance by Service Provider may result in imposition of penalty, liquidated damages, invocation of PBG / Bank Guarantee and / or termination of Contract (as laid down elsewhere in this RFP / SLA document	<p>In this section, if Vendor do not provide the Services within the agreed timeline, then Vendor should inform the Bank immediately and the Bank post evaluation may impose penalty for delay / defect in Services. Hence the below revised clause:</p> <p>Any delay in performing the obligation/ defect in performance by Service Provider may result in imposition of penalty, liquidated damages, invocation of Bank Guarantee and/or termination of Contract (as laid down elsewhere in this RFP document), provided the delay/defect is not due to any Force Majeure Events as stated in RFP.</p>	Terms & Conditions applicable as per RFP
337	4.4.15	BANK GUARANTEE AND PENALTY	4.4.15 Any penalty mentioned anywhere in this RFP / SLA, but not specifically mentioned in Appendix-I (Penalties & Incentives), shall also applicable and binding to the Vendor.	> Request bank to share 24hrs daily transaction report at ATM level to analyze & improve efficiency.	Terms & Conditions applicable as per RFP

337	5.1.1.LIABILITIES / OBLIGATION:	5.1.1 The Bank's Duties /Responsibility (if any)	(i) Processing and authorising invoices	<p>Request Bank to amend the clause as below:</p> <p>(i) Processing and authorising invoices in a timely manner.</p> <p>(ii) For the payments which are not received when due the Bank will pay late payment charges at the rate of 1.5% per month.</p> <p>(iii) The Bank will pay the Service Provider on the then applicable T&amp;M rates for the additional services requested by the Bank from time to time.</p> <p>(iv) The Bank will provide the Service Provider the access to its systems to download the transaction report or the switch report for the transactions.</p> <p>(v) Notwithstanding anything to the contrary in this Agreement, the Bank will not reduce the number of ATM sites beyond 2% of the aggregate from the initial number of ATMs. The Service Provider may at its discretion decide to close or relocate an ATM site if particular ATM sites becomes commercially unviable for the Service Provider due to reduction in</p>	Terms & Conditions applicable as per RFP
-----	---------------------------------	--	---	--	--

		<p>number of transactions.</p> <p>(vi) The Bank should provide its approval for the sites identified by the Service Provider within 7 days from the date of submission of sites by the Service Provider.</p> <p>(vii) If the Bank terminates the Agreement or Services for particular ATM sites for its convenience or for its own business reasons or without assigning any reason then the Bank will pay, as liquidated damages, 35% of the total charges payable by the Bank for the balance of the then current Term (“Termination Fee”) on calculated on the basis of the average monthly charges paid by the Bank during the previous 12 months, within thirty days of the termination date.</p> <p>(viii) At the expiration of the Term without further renewal or on Bank’s termination, the Service Provider may at its sole discretion allow the Bank to (a) purchase the Service Provider’s owned ATMs at a price agreed by the parties or (b) return them to Service Provider, provided the Bank gives Service</p>	
--	--	--	--

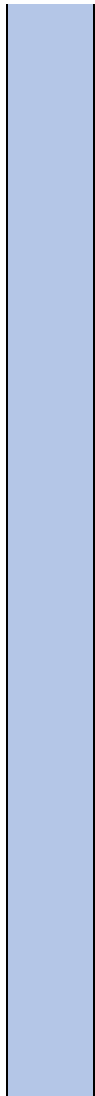

Provider not less than 90 days prior written notice of which the Bank elect to do. If the Service Provider agrees to sell and the Bank agrees to purchase the Service Provider-owned ATMs, the Service Provider will offer to sell licenses to the Software, as installed on the Service Provider's owned ATMs at the expiration, on terms and rates it is then offering to its customer in the market. If the Bank and Service Provider cannot agree on a price prior to the termination date, the Bank will return the Service Provider-owned ATMS.

338	5.1.2	Service Provider duties	(ii) Service Provider shall ensure to filter all phishing / spamming / overflow attacks in order to ensure availability and integrity on continuous basis.	Request The Bank to explain the deliverable needed from the Bidder.	Terms & Conditions applicable as per RFP
338	5.1.2	Service Provider duties	(vi) Service Provider shall provide and implement patches/ upgrades/ updates for hardware/ software/ operating System / middleware etc supplied by the Service Provider as and when released by them/ OEM to keep the ATM in a good operating condition as per its product documentation or as per requirements of the Bank. Service Provider should bring to notice of the Bank all releases/ version changes.	If the Bank requires any additional services then request the Bank to specify that the same need to be provided if it is commercially reasonable to Service Provider and if the there are costs involved then the Bank need to pay for such additional costs as mutually agreed between the Parties.	Terms & Conditions applicable as per RFP

341	6.2.9	6.2 Additional Representation and Warranties by Service Provider	Service provider shall, at the Bank's request, promptly replace the software or specified component with new software of the same type and quality. Such replacement shall be accomplished without any adverse impact on the Bank's operations within agreed time frame and without any additional cost to the Bank.	The Bidder cannot guarantee that it will replace a particular software. Request Bank to delete this clause or else amend this clause that the activity can be completed at mutually agreed rate	Terms & Conditions applicable as per RFP
-----	-------	--	--	---	--

342 7

7. General Indemnity

7. General Indemnity

7.1 Service Provider agrees and hereby keeps the Bank indemnified against all claims, actions, loss, damages, costs, expenses, charges, including legal expenses (Attorney, Advocates fees included) which the Bank may suffer or incur on account of (i) Services Provider's breach of its warranties, covenants, responsibilities or obligations; or (ii) breach of confidentiality obligations mentioned in this Agreement; or (iii) any willful misconduct and gross negligent acts on the part of employees, agents, representatives or subcontractors (if of Service Provider. Servi

Request Bank to amend the section as below:

7 LIABILITY AND LIMITATION OF LIABILITY:

7.1 Service Provider will be liable for claims, actions, loss, damages, costs, expenses, charges, including legal expenses (reasonable Attorney, Advocates fees included) which the Bank may suffer or incur on account of Service Provider's negligence or willful misconduct resulting into: (i) Services Provider's breach of its warranties, covenants, responsibilities or obligations; or (ii) breach of confidentiality obligations mentioned in this Agreement; or (iii) any willful misconduct and gross negligent acts on the part of employees, agents, representatives or subcontractors (if allowed) of Service Provider. Service Provider agrees to make good the loss suffered by the Bank

7.3 The Vendor will be liable to the Bank for its negligence or

Terms & Conditions applicable as per RFP



		<p>ce Provider agrees to make good the loss suffered by the Bank.</p> <p>7.3 The Vendor hereby indemnifies the Bank, and shall always keep indemnified and hold the Bank, its employees, personnel, directors, (hereinafter collectively referred to as "Personnel") harmless from and against any and all losses, liabilities, claims, actions, costs and expenses (including attorneys' fees) awarded against the Bank relating to, resulting directly from or arising out of any claim, suit or proceeding brought against the Bank, as a result of:</p>	<p>willful misconduct resulting into losses, liabilities, claims, actions, costs and expenses (including reasonable attorneys' fees) awarded against the Bank relating to, resulting directly from or arising out of any claim, suit or proceeding brought against the Bank, as a result of:</p> <p>7.3.6 any or all Deliverables or Services infringing any patent, trademarks, copyrights or such other Intellectual Property Rights in accordance with section 7.4 and 7.7 below; and/or</p>	
--	--	---	---	--

		<p><b>7.3.6 any or all Deliverables or Services infringing any patent, trademarks, copyrights or such other Intellectual Property Rights</b></p>		
--	--	--	--	--

342	7	Appendix- J	GENERAL INDEMNITY	<p>The Bidder should be liable for actual, proven losses and for acts directly attributable to the Bidder and cannot be held liable for any indirect claims. Further, the indemnity should survive till the termination and/or expiration of the Agreement. We suggest to also incorporate the below:  <b>Limitation of liability:</b>  We suggest to curtail the limit to 10 % of the relevant order placed form time to time with Bidder.</p> <p>The Bidder will not be responsible for any of data loss attributed to any reasons of force majeure or for other reasons beyond the control of the Vendor (e.g. Natural calamity, electricity failure, data migration, system failure, virus etc.).</p> <p>The Bidder will not be responsible for any malfunctioning of the system due to virus attacks, tampering with the existing software system/data base, hardware/operating system, Database related problems and any fake, forged, soiled, loose notes or for the notes which is</p>	Terms & Conditions applicable as per RFP
-----	---	-------------	-------------------	--	--

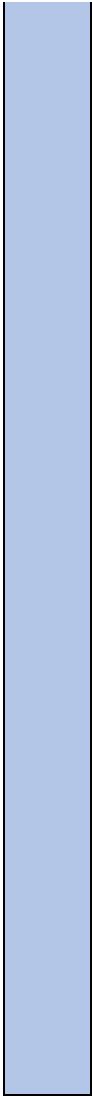

not issued by RBI. Also, if the loss is due to the acts and omissions of the employees of the Bank, Bidder should not be liable for the loss.

<p>342</p>	<p>Appendix-J DRAFT SERVICE LEVEL AGREEMENT</p>	<p>7. GENERAL INDEMNITY:</p>	<p>-</p>	<p>Requested Changes : Similarly Bank shall indemnify, protect and save the Bidder and hold the Bidder harmless from and against all claims, losses, costs, damages, expenses, action suits and other proceedings, (including reasonable attorney fees), relating to or resulting directly or indirectly from</p> <ul style="list-style-type: none"> <li>i breach of any of the terms of this RFP,</li> <li>ii. Infringement of any patent, trademarks, copyrights etc. of the Bidder</li> <li>iii. Bank shall indemnify the Bidder against any loss or damage to the Bidder's premises or property, loss of life, etc., due to the acts of the Bank's employees or representatives.</li> <li>iv. breach of any representation and warranties and breach of its obligations.</li> </ul> <p>However, Bidder shall not be liable for any indirect, incidental, consequential or punitive damages or for any loss of data &amp; loss of life under any circumstances whatsoever to the Bank.</p>	<p>Terms &amp; Conditions applicable as per RFP</p>
------------	---	------------------------------	----------	---	---

342	Appendix J	7.1	Indemnity	<p>The Bidder shall indemnify solley for direct and proven claims. The Bidder should be liable for actual, proven losses and for acts directly attributable to the Bidder and cannot be held liable for any indirect claims. Further, the indemnity should survive till the termination and/or expiration of the Agreement. We suggest to also incorporate the below:</p> <p>Limitation of liability: We suggest to curtail the limit to 10 % of the relevant order placed form time to time with Bidder.</p> <p>The Bidder will not be responsible for any of data loss attributed to any reasons of force majeure or for other reasons beyond the control of the Vendor (e.g. Natural calamity, electricity failure, data migration, system failure, virus etc.).</p> <p>The Bidder will not be responsible for any malfunctioning of the system due to virus attacks, tampering with the existing software system/data base, hardware/operating system,</p>	Terms & Conditions applicable as per RFP
-----	------------	-----	-----------	--	--

			<p>Database related problems and any fake, forged, soiled, loose notes or for the notes which is not issued by RBI. Also, if the loss is due to the acts and omissions of the employees of the Bank, Bidder should not be liable for the loss.</p>	
--	--	--	--	--

344	7	7. General Indemnity	7.3.10 any loss on account of an y skimming, shimming or keypad related fraud committed on the CDs attributable to the manufacturing defect in the CDs and specifically excluding frauds committed by using cards obtained/processed fraudulently outside the purview of reasonable control of the Vendor; and/or	Request Bank to delete this clause:  In the event of manufacturing defect, the Bidder should be responsible to rectify the defect or replace the defective ATM. The Bidder should not be held liable for the fraudulent acts of third party on whom the Bidder has no control.	Terms & Conditions applicable as per RFP
344	7	7. General Indemnity	7.3.11 any cash replenishment shortages committed by any employee of the Vendor and/or CMA engaged by Vendor	Request the Bank to provide evidentiary document that will allow the Bidder to claim the amount from its CIT agency. This can be subject to Bank providing EJs or switch transaction report;	Terms & Conditions applicable as per RFP



344	7	7. General Indemnity	7.3.13 Fraud committed by the Vendors or its representatives resulting in Bank's image getting tarnished. The claim made by Bank in this regard shall be final and binding upon Vendor even though they have made good the monetary loss to the Bank.	If the Bank is seeking compensation for loss of reputation or goodwill then the same cannot be accepted. It is proposed to be deleted.	Terms & Conditions applicable as per RFP
-----	---	----------------------	---	--	--

346	10	<p><b>10. LIQUIDATED DAMAGES:</b></p>	<p>If Service Provider fails to deliver and perform any or all the Services within the stipulated time, schedule as specified in this RFP/Agreement, the Bank may, without prejudice to its other remedies under the RFP/Agreement, and unless otherwise extension of time is agreed upon without the application of liquidated damages, deduct from the Project Cost, as liquidated damages a sum equivalent to 0.5% of total Project Cost for delay of each week or part thereof maximum up to 5% of total Project Cost. Once the maximum deduction is reached, the Bank may consider termination of the Agreement.</p>	<p>Request Bank to amend the clause as The Liquidated Damages should be limited to delay in deployment of ATM sites.</p>	<p>Terms &amp; Conditions applicable as per RFP</p>
-----	----	---------------------------------------	---	--	---

346	Appendix–J DRAFT SERVICE LEVEL AGREEMENT	10. LIQUIDATED DAMAGES:	If Service Provider fails to deliver and perform any or all the Services within the stipulated time, schedule as specified in this RFP/Agreement, the Bank may, without prejudice to its other remedies under the RFP/Agreement , and unless otherwise extension of time is agreed upon without the application of liquidated damages, deduct from the Project Cost, as liquidated damages a sum equivalent to 0.5% of total Project Cost for delay of each week or part thereof maximum up to 5% of total Project Cost. Once the maximum deduction is reached, the Bank may consider termination of the Agreement.	Requested Changes : Bank to provide a cure period in the circumstances mentioned in the clause before levying liquidated damages on the Bidder. Further under no circumstance shall bank levy the liquidated damages without the consent of the Bidder.	Terms & Conditions applicable as per RFP
-----	--	-------------------------	---	---	--

347	12.1	Sub contracting	<p>12.1 As per scope of this agreement, sub contracting of total scope of work is restricted. However, If the Bidder wishes to subcontract any part of scope of work, it will have to obtain specific written permission from the Bank before subcontracting any work to subcontractors. Bank at its own discretion may permit, deny and review the same. The bank may at any time during the contract may cancel the permission given for the subcontracting vendor.</p>	<p>The TOM is based on outsourced model and subcontracting is important aspect. Hence, while the Bank is required to approve the subcontractor, the Bank should not unreasonably delay or deny the approval.</p>	<p>Terms &amp; Conditions applicable as per RFP</p>
-----	------	-----------------	---	--	---

347	12.3	Sub contracting	<p>12.3 In Case of Sub Contracting (if allowed by the Bank), the Service Provider shall provide the complete details of services sub contracted by it including the details of sub contractor(s) and /or its agent along with copy of agreement (SLA) with such sub contractor to the Bank as and when requested.</p>	<p>Request Bank to amend the clause as The Bidders should not be obliged to provide commercial or sensitive information.</p>	<p>Terms &amp; Conditions applicable as per RFP</p>
-----	------	-----------------	---	--	---

348	14	Intellectual Property Rights	<p>14.2 Without the Bank's prior written approval, Service provider will not, in performing the Services, use or incorporate link to or call or depend in any way upon, any software or other intellectual property that is subject to an Open Source or Copy left license or any other agreement that may give rise to any third party claims or to limit the Bank's rights under this RFP.</p>	<p>Request Bank to amend this clause as The Bidder may use open source software in its applications. In such case, the Bidder will ensure that the OSS license will not create obligations on the Bank beyond the Agreement.</p>	<p>Terms &amp; Conditions applicable as per RFP</p>
-----	----	------------------------------	--	--	---

348	14	Intellectual Property Rights	<p>14.4 The Bank will give Bank will give (a) notice to Service Provider of any such claim without delay/provide reasonable assistance to Service Provider in disposing of the claim ; (b) sole authority to defend and settle such claim and; (c) will at no time admit to any liability for or express any intent to settle the claim provided that (i) Service Provider shall not partially settle any such claim without the written consent of the Bank, unless such settlement releases the Bank fully from such claim, (ii) Service Provider shall promptly provide the Bank with copies of all pleadings or similar documents relating to any such claim , (iii) Service Provider shall consult with the</p>	<p>Since it is Bidder's obligation to pay damages ordered against the Bank, the Bidder should have full control of the defense. Request Bank to amend this clause accordingly.</p> <p>Also, Since the bidder is obliged to defend the Bank, the Bidders will appoint its counsel to represent the Bank in litigation. The Bank may appoint its own counsel to confer with the Bidder's counsel.</p>	Terms & Conditions applicable as per RFP
-----	----	------------------------------	--	---	--

		<p>Bank with respect to the defense and settlement of any such claim, and (iv) in any litigation to which the Bank is also a party, the Bank shall be entitled to be separately represented at its own expenses by counsel of its own selection.</p>		
--	--	--	--	--



348	14.4	INTELLECTUAL PROPERTY RIGHTS AND OWNERSHIP	in any litigation to which the Bank is also a party, the Bank shall be entitled to be separately represented at its own expenses by counsel of its own selection.	Bank to share with the Bidder, a copy of their response to such litigation if Bank files a separate response	Terms & Conditions applicable as per RFP
-----	------	--	---	--	--

348	Appendix–J DRAFT SERVICE LEVEL AGREEMENT	14. INTELLECTUAL PROPERTY RIGHTS:	14.3 Subject to clause 14.4 and 14.5 of this RFP, Service Provider shall, at its own expenses without any limitation, indemnify and keep fully and effectively indemnified the Bank against stall costs, claims, damages, demands, expenses and liabilities whatsoever nature arising out of or in connection with all claims of infringement of Intellectual Property Right, including patent, trademark, copyright, trade secret or industrial design rights of any third party arising from the Services or use of the technology / software / products or any part thereof in India or abroad.	Requested Changes : The Bidder shall indemnify the Bank against the losses and damages which are directly attributable to the Bank and not otherwise.	Terms & Conditions applicable as per RFP
-----	--	--------------------------------------	--	--	---

349	14.6, 14.7	Intellectual Property Rights	<p>14.6 Service provider agrees that the Bank owns the entire right, title and interest to any inventions, designs, discoveries, writings and works of authorship, including all intellectual property rights, copyrights. Any work made under this RFP shall be deemed to be 'work made for hire' under any Indian/U.S. or any other applicable copyright laws.</p> <p>14.7 The Intellectual Property Rights on the software code, copyright and source code for various applications/ interfaces developed under this RFP, and any other component/ framework/ middleware used/ developed as pre built software assets to deliver the solution,</p>	<p>The Agreement is for provision of services on TOM and hence, these clauses are not relevant. If the Bank decides to avail services of the Bidder for development of software or application then it will be done under a separate agreement. Hence, request Bank to delete these clauses</p>	<p>Terms &amp; Conditions applicable as per RFP.</p>
-----	------------	------------------------------	---	---	--

		<p>shall belong to the Bank and the Bank shall have complete and unrestricted rights on such property. However, Service Provider shall hold All Intellectual Property rights in any pre built software per se , except for those which have been assigned under this Agreement</p>		
--	--	--	--	--

350	Appendix-J DRAFT SERVICE LEVEL AGREEMENT	16. CONFIDENTIALITY:	-	Requested Changes : This clause should be kept mutual.	Terms & Conditions applicable as per RFP.
353	16.13	Appendix- J	The foregoing obligations (collectively referred to as “Confidentiality Obligations”) set out in this Agreement shall survive the term of this Agreement and for a period of five (5) years thereafter provided Confidentiality Obligations with respect to individually identifiable information, customer’s data of Parties or software in human-readable form (e.g., source code) shall survive in perpetuity.	The confidential information shall be limited for the period of agreement. Perpetual obligation should not be accepted.	Terms & Conditions applicable as per RFP.

354	17	OWNERSHIP	<p>17.1 Service Provider agrees that the Bank owns the entire right, title and interest to any inventions, designs, discoveries, writings and works of authorship, including all intellectual property rights, copyrights. Any work made under this Agreement shall be deemed to be 'work made for hire' under any Indian/U.S. or any other applicable copyright laws.</p> <p>17.2 The Intellectual Property Rights on the software code, copyright and source code for various applications/ interfaces developed under this Agreement, and any other component/ framework/ middleware used/ developed as pre built software assets to deliver the solution, shall belong</p>	Request Bank to remove these clauses as these are not applicable to an OPEX contract	Terms & Conditions applicable as per RFP.
-----	----	-----------	--	--	---

to the Bank and the Bank shall have complete and unrestricted rights on such property. However, Service Provider shall hold All Intellectual Property rights in any pre built software per se , except for those which have been assigned under this Agreement.

354	17.2	Appendix- J	The Intellectual Property Rights on the software code, copyright and source code for various applications/ interfaces developed under this RFP, and any other component/ framework/ middleware used/ developed as pre-built software assets to deliver the solution, shall belong to the Bank and the Bank shall have complete and unrestricted rights on such property.	source code and other IPR should not be transferred and should be the property of Bidder.	Terms & Conditions applicable as per RFP.
354	Appendix-J DRAFT SERVICE LEVEL AGREEMENT	18. TERMINATION:	-	Requested Changes : Similarly Bidder shall also have the right to terminate the Agreement if Bank defaults in fulfilling its obligations under the scope of the Agreement by giving a written notice of 30 days	Terms & Conditions applicable as per RFP.



355	18.3	TERMINATION:	<p>In the event the Bank terminates the Contract in whole or in part for the breaches attributable to Service Provider, the Bank may procure, upon such terms and in such manner as it deems appropriate, Services similar to those undelivered, and subject to clause 20 Service Provider shall be liable to the Bank for any increase in cost for such similar Services. However, Service Provider shall continue performance of the Contract to the extent not terminated.</p>	<p>In case of a breach attributable to the Bidder, Bank's sole right shall be to terminate the agreement and any Services similar to the ones undelivered by the Bidder shall not be placed as Bidder's liability and nor shall the Bidder be responsible to pay for the increase in the cost of such services</p>	<p>Terms &amp; Conditions applicable as per RFP.</p>
-----	------	--------------	---	--	--

355	18.3	TERMINATION:	<p>In the event the Bank terminates the Agreement in whole or in part for the breaches attributable to Service Provider, the Bank may procure, upon such terms and in such manner, as it deems appropriate, Services similar to those undelivered and subject to clause 20 Service Provider shall be liable to the Bank for any increase in costs for such similar Services. However, Service Provider, in case of part termination, shall continue the performance of the Agreement to the extent not terminated.</p>	<p>In this case, if the Bank wants to procure similar Service from other vendor, post termination for breach and if there is any increase in cost for procuring the services from the alternative vendor, the same has to be borne by Bank. Whereas in the RFP, it mentions that Vendor has to bear the increased cost. To be negotiated with the Bank and hence the clause has to be replaced with below revised clause:          "In the event the Bank terminates the Contract in whole or in part for the breaches attributable to the Service Provider subject to limitation of Liability of this RFP, the Bank may procure, upon such terms and in such manner as it deems appropriate, the Services similar to those undelivered at its own cost. However, the Service Provider shall continue performance of the Contract to the extent not terminated."</p>	<p>Terms &amp; Conditions applicable as per RFP.</p>
-----	------	--------------	--	--	--

356	18.4.3	Termination	18.4.3 If any acts of commission or omission on the part of Service Provider or its agents, employees, sub contractors or representatives, in the reasonable opinion of the Bank tantamount to fraud or prejudicial to the interest of the Bank or its employees.	The Clause is very subjective. Request Bank to delete this as other termination grounds are available to the Bank.	Terms & Conditions applicable as per RFP.
357	18.1	Termination	If existing Service Provider is breach of this obligation, they shall be liable for paying a penalty of 10% of the total Project Cost on demand to the Bank, which may be settled from the payment of invoices or Bank Guarantee for the contracted period or by invocation of Bank Guarantee.	Request the bank to not penalise as Bank has already decided to terminate the contract and vendor is supporting for the transition period.	Terms & Conditions applicable as per RFP

359	22	Limitation of Liability	22.1 The maximum aggregate liability of Service Provider, subject to clause 22.3, in respect of any claims, losses, costs or damages arising out of or in connection with this RFP/Agreement shall not exceed the total Project Cost.	Request Bank to amend the clause as The aggregate cap on liability should be limited to 12 months fees as the same would be a huge amount.	Terms & Conditions applicable as per RFP
360	22	Limitation of Liability	Regulatory or statutory fines imposed by a Government or Regulatory agency for non-compliance of statutory or regulatory guidelines applicable to the Bank due to inaction on the part of vendor, provided such guidelines were brought to the notice of service provider. The regulatory and statutory Penalty/fines will be recovered from the vendor for the reasons attributable	If the Bank pays for implementing regulatory or statutory changes then the Service provider will be liable for such negligence. However, the penalty should be limited to 10% of the Annual Project Cost as the Bank also has the responsibility to ensure that the Service Provider complies with regulatory requirements.	Terms & Conditions applicable as per RFP

			to the vendor under the services provided by the vendor to the Bank under the project		
360	22.4.4.	Appendix- J	Regulatory or statutory fines imposed by a Government or Regulatory agency for non-compliance of statutory or regulatory guidelines applicable to the Bank due to inaction on the part of vendor, provided such guidelines were	Compliance of Laws shall be restricted to the services rendered to the Bank under this Project and with such laws which are applicable for the Services and not otherwise.	Terms & Conditions applicable as per RFP

			brought to the notice of service provider.		
361	23.3	FORCE MAJEURE	If a Force Majeure situation arises, Service Provider shall promptly notify the Bank in writing of such condition and the cause thereof. Unless otherwise directed by the Bank in writing, Service Provider shall continue to perform its obligations under the Contract as far as is reasonably practical and shall seek all reasonable alternative means for performance not	In case of a Force Majeure scenario, both parties must evaluate the feasibility of proving and availing services and the decision to perform the obligation under the Contract shall be mutually decided and agreed by the parties	Terms & Conditions applicable as per RFP

			prevented by the Force Majeure event.		
363	26.4	Appendix- J	NON-HIRE AND NON-SOLICITATION	this clause should be mutual. This clause should not be applicable to the Bidder in case the hiring of an employee is done through an advertisement issued public at large viz: newspaper or via any other job websites.	Terms & Conditions applicable as per RFP
366	27.3.ii	Tranche-wise Rollout Plan details:	Circle-wise Installation Numbers (Tentative)	Request to share locations where more than one ATM has to be deployed	Terms & Conditions applicable as per RFP: IT SHALL BE SHARED WITH SUCCESSFUL BIDDERS

382	5 vi	Appendix-N	To cancel all or any other Contracts with the BIDDER. The BIDDER shall be liable to pay compensation for any loss or damage to the BUYER resulting from such cancellation/rescission and the BUYER shall be entitled to deduct the amount so payable from the money(s) due to the BIDDER	In case of cancellation by whatever reasons, Bidder should be entitled for non-cancellable costs i.e. the cost already incurred by the Bidder for the project. Also, If there is additional cost, it should be mutually discussed. And it should be solely attributable to Bidder.	Terms & Conditions applicable as per RFP
387	Appendix O	Appendix-O MANUFACTURERS' AUTHORIZATION FORM FOR ATMs	MANUFACTURERS' AUTHORIZATION FORM FOR ATMs	As per Network Service Provider 2 - Its been understood that the recommended MAF format is only for ATM OEM and VSAT OEM can submit standard MAF. Please confirm.	Terms & Conditions applicable as per RFP
387	Appendix O	Appendix-O MANUFACTURERS' AUTHORIZATION FORM FOR ATMs	MANUFACTURERS' AUTHORIZATION FORM FOR ATMs	As per OEM 1 - Please clarify:  As page no 113 item 6.4.0 mention that is not mandatory to have all keys with Braille. However, on MAF Draft Document, Bank has recommended to confirm if an OEM doesn't have Braille in all key. In this case please clarify bank's view point.	Terms & Conditions applicable as per RFP Clarification: it is a Regulatory guidelines.



387	APPENDIX-O	APPENDIX-O, MANUFACTURERS' AUTHORIZATION FORM FOR ATMs	APPENDIX-O, MANUFACTURERS' AUTHORIZATION FORM FOR ATMs	It is understood that the MAF format is for ATMs and VSAT OEM can submit standard MAF. pls confirm	Terms & Conditions applicable as per RFP
387	APPENDIX-O MANUFACTU RERS' AUTHORIZAT ION FORM FOR ATMs	Appendix O	Each key of EPP / Keypad and FDK (if any) has Braille embossing  <Specify YES / NO>	Please clarify:  As page no 113 item 6.4.0 mention that is not mandatory to have all keys with Braille.  And on this Document, SBI is asking to OEM to confirm if an OEM doesn't have Braille in all key. In this case please clarify bank's stand on the same.	Terms & Conditions applicable as per RFP Clarification: it is a Regulatory guidelines.
387	APPENDIX-O MANUFACTU RERS' AUTHORIZAT ION FORM FOR ATMs	Appendix O	Each key of EPP / Keypad and FDK (if any) has Braille embossing  <Specify YES / NO>	Please clarify:  As page no 113 item 6.4.0 mention that is not mandatory to have all keys with Braille.  And on this Document, SBI is asking to OEM to confirm if an OEM doesn't have Braille in all key. In this case please clarify bank's stand on the same.	Terms & Conditions applicable as per RFP Clarification: it is a Regulatory guidelines.

387	APPENDIX-O MANUFACTURERS' AUTHORIZATION FORM FOR ATMs	Appendix O	Each key of EPP / Keypad and FDK (if any) has Braille embossing  <Specify YES / NO>	Please clarify:  As page no 113 item 6.4.0 mention that is not mandatory to have all keys with Braille.  And on this Document, SBI is asking to OEM to confirm if an OEM doesn't have Braille in all key. In this case please clarify bank's stand on the same.	Terms & Conditions applicable as per RFP Clarification: it is a Regulatory guidelines.
387	APPENDIX-O MANUFACTURERS' AUTHORIZATION FORM FOR ATMs	Appendix O	Each key of EPP / Keypad and FDK (if any) has Braille embossing  <Specify YES / NO>	Please clarify:  As page no 113 item 6.4.0 mention that is not mandatory to have all keys with Braille.  And on this Document, SBI is asking to OEM to confirm if an OEM doesn't have Braille in all key. In this case please clarify bank's stand on the same.	Terms & Conditions applicable as per RFP Clarification: it is a Regulatory guidelines.

387	APPENDIX-O MANUFACTURERS' AUTHORIZATION FORM FOR ATMs		Each key of EPP / Keypad and FDK (if any) has Braille embossing  <Specify YES / NO>	Please clarify:  As page no 113 item 6.4.0 mention that is not mandatory to have all keys with Braille.  And on this Document, SBI is asking to OEM to confirm if an OEM doesn't have Braille in all key. In this case please clarify bank's stand on the same.	Terms & Conditions applicable as per RFP Clarification: it is a Regulatory guidelines.
387	APPENDIX-O,	MANUFACTURERS' AUTHORIZATION FORM FOR ATMs	APPENDIX-O, MANUFACTURERS' AUTHORIZATION FORM FOR ATMs	It is understood that the MAF format is for ATMs and VSAT OEM can submit standard MAF. pls confirm	Terms & Conditions applicable as per RFP
387	APPENDIX-O, MANUFACTURERS' AUTHORIZATION FORM FOR ATMs	APPENDIX-O, MANUFACTURERS' AUTHORIZATION FORM FOR ATMs	APPENDIX-O, MANUFACTURERS' AUTHORIZATION FORM FOR ATMs	It is understood that the MAF format is for ATMs and VSAT OEM can submit standard MAF. pls confirm	Terms & Conditions applicable as per RFP

398	Appendix-R << on letter head of bidder >> Declaration of past and present litigation details	Appendix-R	Appendix-R << on letter head of bidder >> Declaration of past and present litigation details	Requested Changes : Suggestion to limit the litigation details for the services involved.	Terms & Conditions applicable as per RFP
-----	--	------------	--	--	--

400	Appendix-S	Bidder Declaration	<p>7. We agree to provide all services etc. under this RFP for a Minimum period of seven years (with a provision to extend for 3 years at the discretion of the Bank) by deputing our suitable resources at the endpoint or elsewhere as and when required irrespective of number of visits to operationalize or to ensure uptime of endpoint or to repair or to maintain or to carry out any activity apart from preventive maintenance without any additional cost to the Bank</p>	<p>The said commercial should be for 7 years contractual period only. The price to be re-discover after 7 years of the contractual period on mutually agreed basis.</p>	<p>Terms &amp; Conditions applicable as per RFP</p>
-----	------------	--------------------	--	---	---

401	Appendix S	11	<p>We undertake to ensure that in case of installation against replacement, the Hard Disk Drive of the equipment supplied will be handed over to the Branch head / his representative and this will be recorded in the installation report to be signed by our representative and Bank. We also give an undertaking that the integrity of the data on the Hard Disk will not be compromised and put to any misuse, causing financial or reputational loss to the Bank.</p>	<p>In case of replacement cases the respective Bidder/OEM of the old machine will have to send its engineer to remove the HDD and handover to the Bank</p>	<p>Terms &amp; Conditions applicable as per RFP</p>
-----	------------	----	--	--	---

410	III		<p><b>Support for Operating System</b></p> <ul style="list-style-type: none"> <li>▪ Windows 11 / permitted Windows 10, patches, service packs etc.</li> <li>▪ Changes in Operating System configuration (eg. Environment variable, parameter changes, enabling / disabling services etc)</li> <li>▪ End-user License Agreement (EULA)</li> <li>▪ Any other relevant information including Best Practices</li> </ul>	<p><b><u>In case Bank decides to go with Native application,</u></b>  <b>Request Bank to include Linux or modify clause as:</b>  <b>Support for Operating System</b></p> <ul style="list-style-type: none"> <li>• Windows 11 / permitted Windows 10 / Linux , patches, service packs etc.</li> <li>• Changes in Operating System or its configuration (environment variable, parameter changes, enabling / disabling services etc)</li> <li>• End-user License Agreement (EULA)</li> <li>• Any other relevant information including Best Practices</li> </ul>	<p><b>Terms &amp; Conditions applicable as per RFP</b></p>
-----	-----	--	---	---	--

410	III		<p>Support for Operating System</p> <ul style="list-style-type: none"> <li>▪ Windows 11 / permitted Windows 10, patches, service packs etc.</li> <li>▪ Changes in Operating System configuration (eg. Environment variable, parameter changes, enabling / disabling services etc)</li> <li>▪ End-user License Agreement (EULA)</li> <li>▪ Any other relevant information including Best Practices</li> </ul>	<p><u>In case Bank decides to go with Native application,</u> Request Bank to include Linux or modify clause as: Support for Operating System</p> <ul style="list-style-type: none"> <li>• Windows 11 / permitted Windows 10 / Linux , patches, service packs etc.</li> <li>• Changes in Operating System or its configuration (environment variable, parameter changes, enabling / disabling services etc)</li> <li>• End-user License Agreement (EULA)</li> <li>• Any other relevant information including Best Practices</li> </ul>	<p>Terms &amp; Conditions applicable as per RFP</p>
418	19	Annexure 8 EXTERNAL DIGITAL SIGNAGE SOLUTION	<p>Smart Content Download: Schedule time to download content as per bank guidelines, distribute bandwidth equally amongst connected displays for better bandwidth utilisation, Resume downloads in case of connectivity issues</p>	<p>Please clarify, mode of communication for EDSS (Dedicated or Shared with ATM Network)</p>	<p>Terms &amp; Conditions applicable as per RFP</p>



418	ANNEXURE-8 EXTERNAL DIGITAL SIGNAGE SOLUTION DETAILED TECHNICAL SPECIFICATIO NS OF LED EXTERNAL DIGITAL SIGNAGE SOLUTION:			No Specifications of Power supply given	Terms & Conditions applicable as per RFP
-----	---	--	--	--	---

418	<b>ANNEXURE-8 EXTERNAL DIGITAL SIGNAGE SOLUTION DETAILED TECHNICAL SPECIFICATIO NS OF LED EXTERNAL DIGITAL SIGNAGE SOLUTION:</b>			<b>Warranty Terms not mentioned</b> <b>1.Number of Years</b> <b>2.Maintenance procedure and charges post Warranty coverage</b> <b>3.Operational Hours of Digital Signages not specified</b>	<b>Terms &amp; Conditions applicable as per RFP</b>
-----	--	--	--	--	---

418	ANNEXURE-8 EXTERNAL DIGITAL SIGNAGE SOLUTION DETAILED TECHNICAL SPECIFICATIO NS OF LED EXTERNAL DIGITAL SIGNAGE SOLUTION:			IP Rating Not specified , IP 65 for Modules & IP 67 for Power Supplies Recommended	Terms & Conditions applicable as per RFP
420	9	Content Management Software Features	Group displays and schedule same content at once to all the displays in the group	Group Display at one time is not Possible as Size will be differ on location with Pixel with Individual Controllers per Location.	Terms & Conditions applicable as per RFP

420	18	Content Management Software Features	Centrally turn ON/OFF USB Ports / HDMI Ports / other Ports (Can be scheduled or on demand through commands)	Hardware Ports can be disabled but cannot be disabled via Cloud Software although this won't be required at all as Device's are Locked Permanently post taken on Cloud as soon as the installation is done	Terms & Conditions applicable as per RFP
NIL	General Observation	GeM Portal	Offer Price	Request Bank to specify Financial and Non-Financial per Txn under Offer price category in GeM portal, same is not clearly mentioned.	Terms & Conditions applicable as per RFP Clarification: Price will be quoted for each line items i.e, financial and non-financial under-price bid.
NIL	General Observation	General Observation	General Observation	Bidder would like to clarify that, if there is any cost impact on the scope of services/any compliance/Upgradation of software hardware, security measures/minimum wages by any new law, regulation, guidelines, that cost will be borne by the Bank.	Terms & Conditions applicable as per RFP
NIL			General	Request the bank to share average monthly financial and on-financial ATM transaction count for last 13 months. This is required for commercial understanding and for better planning.	Terms & Conditions applicable as per RFP Clarification:
NIL			General	Request the bank to change the selection process to techno-commercial instead of reverse auction	Terms & Conditions applicable as per RFP

